



OIL & GAS DEVELOPMENT COMPANY LTD.

TENDER DOCUMENTS

FOR

Provision of Facilities for General Public in RHC Dhuman, District Chakwal

INVITATION FOR BIDS

Date: _____

Bid / Procurement No.: _____

1. The Employer, Oil & Gas Development Company Limited (OGDCL), invites sealed bids from eligible firms or persons licensed by the Pakistan Engineering Council in the appropriate category and duly meet technical evaluation criteria for "Provision of Facilities for General Public in RHC Dhuman, District Chakwal"

with the estimated cost and completion period as mentioned in the Press advertisement and Bid documents.

2. A complete set of Bidding Documents may be downloaded by an interested eligible bidder from OGDCL website, www.ogdcl.com, under tender tab. Further information may be obtained from the office of the General Manager (SCM), Oil & Gas Development Company, OGDCL House, Jinnah Avenue Blue area, Islamabad. Ph :051-920023540, Fax :051-9244139
Email :zahid.abbas@ogdcl.com

-
3. Technical bids must be accompanied by a Bid Security in the amount as mentioned in the press advertisement. Both Technical and Financial Bids under Single Stage Two Envelope Procedure of PPRA rules must be delivered to "General Manager(SCM), Oil & Gas Development Company Limited, OGDCL House, Jinnah Avenue, Blue Area, Islamabad" on or before the time and date mentioned in the press advertisement. Bids will be opened at the time & date mentioned in the press advertisement, in the presence of bidders' representatives who choose to attend, at the same address.

**INSTRUCTIONS
TO BIDDERS
&
BIDDING DATA**

TABLE OF CONTENTS

INSTRUCTIONS TO BIDDERS

<i>Clause No.</i>	<i>Description</i>	<i>Page No.</i>
A. GENERAL		
IB.1	Scope of Bid & Source of Funds	7
IB.2	Eligible Bidders	7
IB.3	Cost of Bidding	7
B. BIDDING DOCUMENTS		
IB.4	Contents of Bidding Documents	7
IB.5	Clarification of Bidding Documents	8
IB.6	Amendment of Bidding Documents	8
C- PREPARATION OF BID		
IB.7	Language of Bid	9
IB.8	Documents Comprising the Bid	9
IB.9	Sufficiency of Bid	9
IB.10	Bid Prices, Currency of Bid & Payment	10
IB.11	Documents Establishing Bidder's Eligibility and Qualifications	10
IB.12	Documents Establishing Works Conformity to Bidding Documents	10
IB.13	Bidding Security	10
IB.14	Validity of Bids, Format, Signing and Submission of Bid	11
D-SUBMISSION OF BID		
IB.15	Deadline for Submission, Modification & Withdrawal of Bids	12
E. BID OPENING AND EVALUATION		
IB.16	Bid Opening, Clarification and Evaluation	12
IB.17	Process to be Confidential	15
F. AWARD OF CONTRACT		
IB.18	Qualification	15
IB.19	Award Criteria & Employers Right	15
IB.20	Notification of Award & Signing of Contract Agreement	16
IB.21	Performance Security	16
IB.22	Integrity Pact	16

INSTRUCTIONS TO BIDDERS

A. GENERAL

IB.1 Scope of Bid & Source of Funds

1.1 Scope of Bid

The Employer as defined in the Bidding Data (hereinafter called “the Employer”) wishes to receive Bids for the Works summarized in the Bidding Data (hereinafter referred to as “the Works”).

Bidders must quote for the complete scope of work. Any Bid covering partial scope of work will be rejected as non-responsive.

1.2 Source of Funds

The Employer has arranged funds from its own sources.

IB.2 Eligible Bidders

2.1 Bidding is open to all firms and persons meeting the following requirements:

- a) duly licensed by the Pakistan Engineering Council (PEC) in the appropriate category for value of Works.
- b) duly meet technical criteria mentioned in these bid documents.

IB.3 Cost of Bidding

3.1 The bidder shall bear all costs associated with the preparation and submission of its bid and the Employer will in no case be responsible or liable for those costs, regardless of the conduct or outcome of the bidding process.

B. BIDDING DOCUMENTS

IB.4 Contents of Bidding Documents

4.1 In addition to Invitation for Bids, the Bidding Documents are those stated below, and should be read in conjunction with any Addendum issued in accordance with Sub-Clause IB.6.1.

1. Instructions to Bidders & Bidding Data

2. Form of Bid & Schedules to Bid
Schedules to Bid comprise the following:
 - (i) Schedule A: Schedule of Prices
 - (ii) Schedule B: Specific Works Data
 - (iii) Schedule C: Works to be Performed by Subcontractors
 - (iv) Schedule D: Proposed Programme of Works
 - (v) Schedule E: Method of Performing Works
 - (vi) Schedule F: Integrity Pact
3. Conditions of Contract & Contract Data
4. Standard Forms:
 - (i) Form of Bid Security
 - (ii) Form of Performance Security
 - (iii) Form of Contract Agreement
 - (iv) Form of Bank Guarantee for Advance Payment
5. Specifications
6. Drawings, if any

IB.5 Clarification of Bidding Documents

- 5.1 A prospective bidder requiring any clarification(s) in respect of the Bidding Documents may notify the Engineer/Employer at the Employer's/Engineer's address indicated in the Bidding Data.
- 5.2 The Engineer/Employer will respond to any request for clarification which it receives earlier than ten (10) days prior to the deadline for the submission of Bids. Copies of the Engineer/Employer's response will be uploaded on OGDCL website for all prospective bidders, at least five (5) days prior to dead line for submission of Bids, who have downloaded the Bidding Documents including a description of the enquiry but without identifying its source.

IB.6 Amendment of Bidding Documents

- 6.1 At any time prior to the deadline for submission of Bids, the Employer may, for any reason, whether at his own initiative or in response to a clarification requested by a prospective bidder, modify the Bidding Documents by issuing addendum.
- 6.2 Any addendum thus issued shall be part of the Bidding Documents pursuant to Sub-Clause 6.1 hereof, and shall be uploaded on company website for all prospective bidders. Prospective bidders shall download all addendas, uploaded before the bid opening, for preparation of their bids. Employer shall bear no responsibility, in case of failure of the any bidder to download the addendas and prepare his bid accordingly.

- 6.3 To afford prospective bidders reasonable time in which to take an addendum into account in preparing their Bids, the Employer may at its discretion extend the deadline for submission of Bids or otherwise, depending on the quantum of work required due to addendum.

C. PREPARATION OF BIDS

IB.7 Language of Bid

- 7.1 The bid prepared by the bidder and all correspondence and documents relating to the Bid, exchanged by the bidder and the Employer shall be written in the English language, provided that any printed literature furnished by the bidder may be written in another language so long as accompanied by an English translation of its pertinent passages in which case, for purposes of interpretation of the Bid, the English translation shall govern.

IB.8 Documents Comprising the Bid

- 8.1 The bid prepared by the bidder shall comprise the following components:
- (a) Covering Letter
 - (b) Form of Bid duly filled, signed and sealed, in accordance with Sub-Clause IB.14.3.
 - (c) Schedules (A to F) to Bid duly filled and initialed, in accordance with the instructions contained therein & in accordance with Sub-Clause IB.14.2.
 - (d) Bid Security furnished in accordance with Clause IB.13.
 - (e) Power of Attorney in accordance with Sub-Clause IB.14.5.
 - (f) Documentary evidence in accordance with Clause IB.11
 - (g) Documentary evidence in accordance with Clause IB.12.

IB.9 Sufficiency of Bid

- 9.1 Each bidder shall satisfy himself before Bidding as to the correctness and sufficiency of his Bid and of the rates and prices entered in the Schedule of Prices, which rates and prices shall except in so far as it is otherwise expressly provided in the Contract, cover all his obligations under the Contract and all matters and things necessary for the proper completion of the Works.

9.2 The bidder is advised to obtain for himself at his own cost and responsibility all information that may be necessary for preparing the bid and entering into a Contract for execution of the Works.

IB.10 Bid Prices, Currency of Bid and Payment

10.1 The bidder shall fill up the Schedule of Prices (Schedule A to Bid) indicating the unit rates and prices of the Works to be performed under the Contract. Prices in the Schedule of Prices shall be entered keeping in view the instructions contained in the Preamble to Schedule of Prices.

10.2 Unless otherwise stipulated in the Conditions of Contract, prices quoted by the bidder shall remain fixed during the bidder's performance of the Contract and not subject to variation on any account.

10.3 The unit rates and prices in the Schedule of Prices shall be quoted by the bidder in the currency as stipulated in Bidding Data.

IB.11 Documents Establishing Bidder's Eligibility and Qualifications

11.1 Pursuant to Clause IB.8, the bidder shall furnish, as part of its technical bid, documents establishing the bidder's eligibility to bid and its qualifications to perform the Contract if its bid is accepted.

11.2 Bidder/Manufacturer must possess and provide, as part of technical bid, evidence of its capability and the experience as stipulated in Bidding Data and the Qualification Criteria stipulated in the Bidding Documents.

IB.12 Documents Establishing Works' Conformity to Bidding Documents

12.1 The documentary evidence of the Works' conformity to the Bidding Documents may be in the form of literature, drawings and data and the bidder shall furnish documentation as set out in Bidding Data.

12.2 The bidder shall note that standards for workmanship, material and equipment, and references to brand names or catalogue numbers, if any, designated by the Employer in the Technical Provisions are intended to be descriptive only and not restrictive.

IB.13 Bid Security

13.1 Each bidder shall furnish, as part of his bid, at the option of the bidder, a Bid Security in the amount stipulated in Bidding Data in Pak. Rupees in the form of Bank Draft/Call Deposit Pay order or Bank Guarantees per format provided) in favour of Employer valid for a period up to twenty eight days (28) beyond the bid) validity date. Bid Security in the form of Bank Guarantee will not be acceptable, with the banks whose market price per share is quoted below the Par Value at Stock Exchange. Crossed Cheque/Insurance Guarantee/Swift Message will not be acceptable

- 13.2 Any bid not accompanied by an acceptable Bid Security shall be rejected by the Employer as non-responsive.
- 13.3 The bid securities of unsuccessful bidders will be returned upon award of contract to the successful bidder or on the expiry of validity of Bid Security whichever is earlier.
- 13.4 The Bid Security of the successful bidder will be returned when the bidder has furnished the required Performance Security, pursuant to Clause IB.21 and signed the Contract Agreement, pursuant to Sub-Clauses IB.20.2 & 20.3.
- 13.5 The Bid Security may be forfeited if a bidder fails to fulfill agreed tender/contract terms and conditions as under :
- (a) if a bidder withdraws his bid during the period of bid validity; or
 - (b) if a bidder does not accept the correction of his Bid Price, pursuant to Sub-Clause 16.4 (b) hereof; or
 - (c) in the case of a successful bidder, if he fails to:
 - (i) furnish the required Performance Security in accordance with Clause IB.21, or
 - (ii) sign the Contract Agreement, in accordance with Sub-Clauses IB.20.2 & 20.3.
 - (iii) Documents submitted by bidder were found forged during procurement/Tendering Process

Validity of Bids, Format, Signing and Submission of Bid

Bids shall remain valid for the period stipulated in the Bidding Data after the date of bid opening.

All Schedules to Bid are to be properly completed and signed.

No alteration is to be made in the Form of Bid except in filling up the blanks as directed. If any alteration be made or if these instructions be not fully complied with, the bid may be rejected.

Each bidder shall prepare Original and number of copies specified in the Bidding Data of the documents comprising the bid as described in Clause IB.8 and clearly mark them "ORIGINAL" and "COPY" as appropriate. In the event of discrepancy between them, the original shall prevail.

The original and all copies of the bid shall be typed or written in indelible ink and shall be signed by a person or persons duly authorized to sign (in the case of copies, Photostats are also acceptable). This shall be indicated by submitting a written Power of Attorney authorising the signatory of the bidder to act for and on behalf of the bidder. All pages of the bid shall be initialed and official seal be affixed by the person or persons signing the

bid.

- 14.6 The Bid shall be delivered in person or sent by registered mail at the address to Employer as given in Bidding Data.

D. SUBMISSION OF BID

IB.15 Deadline for Submission, Modification & Withdrawal of Bids

- 15.1 Bids must be received by the Employer at the address/provided in Bidding Data not later than the time and date as mentioned in the press advertisement.
- 15.2 Bids submitted through telegraph, telex, fax or e-mail shall not be considered.
- 15.3 Any bid received by the Employer after the deadline for submission prescribed in Bidding Data will be returned unopened to such bidder.
- 15.4 Any bidder may modify or withdraw his bid after bid submission provided that the modification or written notice of withdrawal is received by the Employer prior to the deadline for submission of bids.
- 15.5 Withdrawal of a bid during the interval between the deadline for submission of bids and the expiration of the period of bid validity specified in the Form of Bid may result in forfeiture of the Bid Security pursuant to Sub-Clause IB.13.5(a).

E. BID OPENING AND EVALUATION

IB.16 Bid Opening, Clarification and Evaluation

- 16.1 The Employer will open the bids, in the presence of bidders' representatives who choose to attend, at the time, date and location stipulated in the press advertisement.
- 16.2 The bidder's name, Bid Prices, any discount, the presence or absence of Bid Security, and such other details as the Employer at its discretion may consider appropriate, will be announced by the Employer at the bid opening. The Employer will record the minutes of the bid opening. Representatives of the bidders who choose to attend shall sign the attendance sheet.

Any Bid Price or discount which is not read out and recorded at bid opening will not be taken into account in the evaluation of bid.

- 16.3 To assist in the examination, evaluation and comparison of Bids the Engineer/Employer may, at its discretion, ask the bidder for a clarification of its Bid. The request for clarification and the response shall be in writing and no change in the price or substance of the Bid shall be sought, offered or permitted.

16.4 (a) Prior to the detailed evaluation, pursuant to Sub-Clauses IB.16.7 to 16.9, the Engineer/Employer will determine the substantial responsiveness of each bid to the Bidding Documents. For purpose of these Clauses, a substantially responsive bid is one which conforms to all the terms and conditions of the Bidding Documents without material deviations. It will include to determine the requirements listed in Bidding Data.

(b) Arithmetical errors will be rectified on the following basis:

If there is a discrepancy between the unit price and total price that is obtained by multiplying the unit price and quantity, the unit price shall prevail and the total price shall be corrected. If there is a discrepancy between the words and figures the amount in words shall prevail. If there is a discrepancy between the Total Bid price entered in Form of Bid and the total shown in Schedule of Prices-Summary, the amount stated in the Form of Bid will be corrected by the Employer in accordance with the Corrected Schedule of Prices.

If the bidder does not accept the corrected amount of Bid, his Bid will be rejected and his Bid Security forfeited.

16.5 A Bid determined as substantially non-responsive will be rejected and will not subsequently be made responsive by the bidder by correction of the non-conformity.

16.6 Any minor informality or non-conformity or irregularity in a Bid which does not constitute a material deviation may be waived by Employer, provided such waiver does not prejudice or affect the relative ranking of any other bidders.

16.7 The Engineer/Employer will evaluate and compare only the bids previously determined to be substantially responsive pursuant to Sub-Clauses IB.16.4 to 16.6 as per requirements given hereunder. Bids will be evaluated for complete scope of works. The prices will be compared on the basis of the Evaluated Bid Price pursuant to Sub-Clause 16.8 herein below.

(a) Technical Evaluation

It will be examined in detail whether the Works offered by the bidder complies with the Technical Provisions of the Bidding Documents. For this purpose, the bidder's data submitted with the bid in Schedule B to Bid will be compared with technical features/criteria of the Works detailed in the Technical Provisions. Other technical information submitted with the bid regarding the Scope of Work will also be reviewed.

(b) Commercial Evaluation

It will be examined in detail whether the bids comply with the commercial/contractual conditions of the Bidding Documents. It is expected that no material deviation/stipulation shall be taken by the bidders.

16.8 Evaluated Bid Price

In evaluating the bids, the Engineer/Employer will determine for each bid in addition to the Bid Price, the following factors (adjustments) in the manner and to the extent indicated below to determine the Evaluated Bid Price:

- (i) making any correction for arithmetic errors pursuant to Sub-Clause 16.4 hereof.
- (ii) discount, if any, offered by the bidders as also read out and recorded at the time of bid opening.

IB.17 Process to be Confidential

- 17.1 Subject to Sub-Clause IB.16.3 heretofore, no bidder shall contact Engineer/Employer on any matter relating to its Bid from the time of the Bid opening to the time the bid evaluation result is announced by the Employer. The evaluation result shall be announced at least ten (10) days prior to award of Contract. The announcement to all bidders will include table(s) comprising read out prices, discounted prices, price adjustments made, final evaluated prices and recommendations against all the bids evaluated.
- 17.2 Any effort by a bidder to influence Engineer/Employer in the Bid evaluation, Bid comparison or Contract Award decisions may result in the rejection of his Bid. Whereas, any bidder feeling aggrieved may lodge a written complaint not later than fifteen (15) days after the announcement of the bid evaluation result, however, mere fact of lodging a complaint shall not warrant suspension of procurement process.

F. AWARD OF CONTRACT

IB.18. Post Qualification

- 18.1 The Employer, at any stage of the bid evaluation, having credible reasons for or *prima facie* evidence of any defect in supplier's or contractor's capacities, may require the suppliers or contractors to provide information concerning their professional, technical, financial, legal or managerial competence whether already pre-qualified or not:

Provided that such qualification shall only be laid down after recording reasons therefor in writing. They shall form part of the records of that bid evaluation report.

- 18.2 The determination will take into account the bidder's financial and technical capabilities. It will be based upon an examination of the documentary evidence of the bidders' qualifications submitted under Clause IB.11, as well as such other information required in the Bidding Documents.

IB.19 Award Criteria & Employer's Right

- 19.1 Subject to Sub-Clause IB.19.2, the Employer will award the Contract to the bidder whose bid has been determined to be substantially responsive to the Bidding Documents and who has offered the lowest evaluated Bid Price, provided that such bidder has been determined to be qualified to satisfactory perform the Contract in accordance with the provisions of Clause IB.18.
- 19.2 Not with standing Sub-Clause IB.19.1, the Employer reserves the right to accept or reject any bid, and to annul the bidding process and reject all bids, at any time prior to award of Contract, without thereby incurring any liability to the affected bidders or any obligation to inform the affected bidders of the grounds for the Employer's action except that the

grounds for its rejection of all bids shall upon request be communicated, to any bidder who submitted a bid, without justification of the grounds. Notice of the rejection of all the bids shall be given promptly to all the bidders.

IB.20 Notification of Award & Signing of Contract Agreement

- 20.1 Prior to expiration of the period of bid validity prescribed by the Employer, the Employer will notify the successful bidder in writing (“Letter of Acceptance”) that his bid has been accepted.
- 20.2 Within seven (7) days from the date of furnishing of acceptable Performance Security under the Conditions of Contract, the Employer will send the successful bidder the Form of Contract Agreement provided in the Bidding Documents, incorporating all agreements between the parties.
- 20.3 The formal Agreement between the Employer and the successful bidder shall be executed within seven (7) days of the receipt of Form of Contract Agreement by the successful bidder from the Employer.

IB.21 Performance Security

- 21.1 The successful bidder shall furnish to the Employer a Performance Security in the form and the amount stipulated in the Conditions of Contract within a period of fourteen (14) days after the receipt of Letter of Acceptance.
- 21.2 Failure of the successful bidder to comply with the requirements of Sub-Clauses IB.20.2 & 20.3 or 21.1 or Clause IB.22 shall constitute sufficient grounds for the annulment of the award and forfeiture of the Bid Security.

IB.22 Integrity Pact

The Bidder shall sign and stamp the Form of Integrity Pact provided at Schedule-F to Bid in the Bidding Document for all Federal Government procurement contracts exceeding Rupees ten (10) million. Failure to provide such Integrity Pact shall make the bid non-responsive.

BIDDING DATA

Instructions to Bidders

Clause Reference

1.1 Name of Employer

Oil & Gas Development Company Limited, (OGDCL), OGDCL House, Jinnah Avenue, Blue Area, Islamabad.

Brief Description of Works

" Provision of Facilities for General Public in RHC Dhuman, District Chakwal"

5.1 (a) Employer's address:

General Manager(SCM), Oil & Gas Development Company Limited, OGDCL House, Jinnah Avenue, Blue Area, Islamabad. Ph.051-920023540 Fax. No. 051-9244139 email address: zahid.abbas@ogdcl.com

(b) Engineer's address: As per Workorder.

10.3 Bid shall be quoted entirely in Pak. Rupees. The payment shall be made in Pak. Rupees.

11.2 The bidder/manufacturer has the financial, technical and experience capability necessary to perform the Contract as per Technical Evaluation criteria given at the end of the "Contract Data" Part.

12.1 (a) A detailed description of the Works, essential technical and performance characteristics.

(b) Complete set of technical information, description data, literature and drawings as required in accordance with Schedule B to Bid, Specific Works Data. This will include but not be limited to a sufficient number of drawings, photographs, catalogues, illustrations and such other information as is necessary to illustrate clearly the significant characteristics such as general construction dimensions and other relevant information about the works to be performed.

13.1 Amount of Bid Security

Bid Security in the amount as mentioned in the press advertisement.

14.1 Period of Bid Validity

100 calender days. The bid validity period may be extended by the bidder in case of expiry of the bid validity, at the request of the employer. If the contractor will not extend the bid validity then his bid security may be released without any forfeiture.

14.4 Number of Copies of the Bid to be Submitted

One original.

14.6 (a) Employer's Address for the Purpose of Bid Submission

General Manager(SCM), Oil & Gas Development Company Limited, OGDCL House, Jinnah Avenue, Blue Area, Islamabad.

15.1 Deadline for Submission of Bids

As per press advertisement.

16.1 Venue, Time, and Date of Bid Opening

As per press advertisement.

16.4 Responsiveness of Bids

- (i) the Bid is valid till required period,
- (ii) the Bid prices are firm during currency of contract.
- (iii) completion period offered is within specified limits as mentioned in press advertisement.
- (iv) the Bidder/Manufacturer is eligible to Bid and possesses the requisite experience, capability and qualification.
- (v) the Bid does not deviate from basic technical requirements and
- (vi) the Bids are generally in order, etc.

16.7 (a) Technical Evaluation

A table of Technical Evaluation criteria is attached below, which shall be filled by Owner/Consultant. Accordingly contractor's technical evaluation shall be carried out as per technical evaluation criteria given in contract data.

FORM OF BID AND SCHEDULES TO BID

FORM OF BID

(LETTER OF OFFER)

Bid Enquiry No. _____
Construction of _____

(Name of Works)

To:

General Manager(SCM),
Oil & Gas Development Company Limited,
OGDCL House, Jinnah Avenue, Blue Area, Islamabad.

Gentlemen,

1. Having examined the Bidding Documents including Instructions to Bidders, Bidding Data, Conditions of Contract, Contract Data, Specifications, Drawings, if any, Schedule of Prices and Addenda Nos. _____ for the execution of the above-named Works, we, the undersigned, being a company doing business under the name of and address _____ and being duly incorporated under the laws of Pakistan hereby offer to execute and complete such Works and remedy any defects therein in conformity with the said Documents including Addenda thereto for the Total Bid Price of Rs _____ (Rupees _____) or such other sum as may be ascertained in accordance with the said Documents.
2. We understand that all the Schedules attached hereto form part of this Bid.
3. As security for due performance of the undertakings and obligations of this Bid, we submit herewith a Bid Security in the amount of _____ drawn in your favour or made payable to you and valid for a period of twenty eight (28) days beyond the period of validity of Bid.
4. We undertake, if our Bid is accepted, to commence the Works and to deliver and complete the Works comprised in the Contract within the time(s) stated in Contract Data.
5. We agree to abide by this Bid for the period of 100 days from the date fixed for receiving the same and it shall remain binding upon us and may be accepted at any time before the expiration of that period.
6. Unless and until a formal Agreement is prepared and executed, this Bid, together with your written acceptance thereof, shall constitute a binding contract between us.
7. We undertake, if our Bid is accepted, to execute the Performance Security referred to in Conditions of Contract for the due performance of the Contract.

8. We understand that you are not bound to accept the lowest or any bid you may receive.
9. We do hereby declare that the Bid is made without any collusion, comparison of figures or arrangement with any other person or persons making a bid for the Works.
10. We understand that Performance Bond shall be in the stipulated form @ 10 % of contract price and will be provided to you within 14 days from the date of issuance of LOI In case of non-compliance our Bid Security shall be forfeited.

Dated this _____ day of _____, 2020

Signature _____

in the capacity of _____ duly authorized to sign bid for and on behalf of

(Name of Bidder in Block Capitals)

(Seal)

Address

Witness:

(Signature) _____

Name: _____

Address: _____

[SCHEDULES TO BID INCLUDE THE FOLLOWING:

- Schedule A to Bid: Schedule of Prices
- Schedule B to Bid: Specific Works Data
- Schedule C to Bid: Works to be Performed by Subcontractors
- Schedule D to Bid: Proposed Programme of Works
- Schedule E to Bid: Method of Performing Works
- Schedule F to Bid: Integrity Pact]

SCHEDULE – A TO BID
SCHEDULE OF PRICES

<u>Sr. No.</u>		<u>Page No.</u>
1.	Preamble to Schedule of Prices	26
2.	Schedule of Prices	29
	(a) Bill of Quantities	

PREAMBLE TO SCHEDULE OF PRICES

1. General

- 1.1 The Schedule of Prices shall be read in conjunction with the Conditions of Contract, Contract Data together with the Specifications and Drawings, if any.
- 1.2 The Contract shall be for the whole of the Works as described in these Bidding Documents. Bids must be for the complete scope of works.

2. Description

- 2.1 The general directions and descriptions of works and materials are not necessarily repeated nor summarized in the Schedule of Prices. References to the relevant sections of the Bidding Documents shall be made before entering prices against each item in the Schedule of Prices.

3. Units & Abbreviations

- 3.1 Units of measurement, symbols and abbreviations expressed in the Bidding Documents shall comply with the Systeme Internationale d' Unites (SI Units) or customary units for certain items as convenient to employer.

4. Rates and Prices

- 4.1 Except as otherwise expressly provided under the Conditions of Contract, the rates and amounts entered in the Schedule of Prices shall be the rates at which the Contractor shall be paid and shall be the full inclusive value of the works set forth or implied in the Contract; except for the amounts reimbursable, if any to the Contractor under the Contract.
- 4.2 Unless otherwise stipulated in the Contract Data, the rates and prices entered by the bidder shall not be subject to adjustment during the performance of the Contract.
- 4.3 All duties, taxes and other levies payable by the Contractor shall be included in the rates and prices.
- 4.4 The whole cost of complying with the provisions of the Contract shall be included in the items provided in the Schedule of Prices, and where no items are provided, the cost shall be deemed to be distributed among the rates and prices entered for the related items of the Works and no separate payment will be made for those items.

The rates, prices and amounts shall be entered against each item in the

SCHEDULE - A TO BID

Schedule of Prices. Any item against which no rate or price is entered by the bidder will not be paid for by the Employer when executed and shall be deemed covered by the rates and prices for other items in the Schedule of Prices.

- 4.5 (a) The bidder shall be deemed to have obtained all information as to and all requirements related thereto which may affect the bid price.
- (b) The Contractor shall be responsible to make complete arrangements for the transportation of the Plant to the Site.
- 4.6 The Contractor shall provide for all parts of the Works to be completed in every respect. Notwithstanding that any details, accessories, etc. required for the complete installation and satisfactory operation of the Works, are not specifically mentioned in the Specifications, such details shall be considered as included in the Contract Price.

5. Bid Prices

5.1 Break-up of Bid Prices

The various elements of Bid Prices shall be quoted as detailed by the Employer in the format of Schedule of Prices.

The bidder shall recognize such elements of the costs which he expects to incur the performance of the Works and shall include all such costs in the rates and amounts entered in the Schedule of Prices.

6. Provisional Sums

- 6.1** Provisional Sums included and so designated in the Schedule of Prices if any, shall be expended in whole or in part at the direction and discretion of the Engineer/Employer. The Contractor will only receive payment in respect of Provisional Sums if he has been instructed by the Engineer/Employer to utilise such sums.

OIL AND GAS DEVELOPMENT COMPANY LIMITED

(CORPORATE SOCIAL RESPONSIBILITY DEPARTMENT)

ABSTRACT OF QUANTITIES AND COST

CONSTRUCTION OF DISPENSARY / GRAGE AT RHC DHUMAN DISTRICT CHAKWAL					
S.NO	Description	Quantities	Unit	Unit rate inclusive all applicable taxes exclusive of PST/ICT	Total cost inclusive all applicable taxes Exclusive of PST/ICT
1	Construction of dispensary/garage 30'x30' and attach bath room 6'x6' as per drawings and specification.	992.25	SFT		
3	Construction of RCC semi covered waiting shed 20' x40 as per drawings and specifications	892.25	SFT		
4	Providing and fixing of 24volts solar lights, with 50 watts SMD LED Street lights, with 5 days back up, deep cycle dry imported batteries and 20' high GI tubular pole with all civil works complete in a respect.	5	Each		
A	Grand total inclusive of all applicable taxes, exclusive of PST/ICT Sale tax. Rs				
B	Percentage _____ % above / below (tick one) the estimated cost.				Rs
C	Total amount inclusive of percentage above or below as quoted above (A+B)				Rs
D	Rate and amount of PST/ICT Sale tax on total amount at serial C (Rs) @ _____%				
E	Grand total inclusive of all applicable taxes with PST/ICT (C+D)				Rs
	Total bid amount in words _____				

Note

1. The rate and amount given in the BOQ are inclusive of all applicable taxes, excluding PST/ICT, The rate and amount of PST/ICT Sale tax will be mentioned separately in the above referred relevant row/column.
2. Bidder (S) must submit complete tender documents as available on web site and having duly stamped and signed at the time of submission of bid otherwise OGDCL reserves the right to reject the bid.
3. Bidder (s) shall clearly mention if he is opting for reduce rate of PST/ICT and his bid shall be evaluated accordingly by adding reduced sales tax in their bid price. Whereas, the bidders who opt for full rate of PST/ICT sale tax, there bid will be evaluated excluding PST/ICT, no change will be acceptable in the option of rate of PST/ICT sale tax after submission of the bid.
4. The contractor being registered with respective revenue authority is entitled to charge applicable sales tax over and above its bid price (excluding sale tax) and will be responsible for the pavements of such sales tax to the respective revenue authority as per prevailing laws. OGDCL shall reimburse the amount of sale tax to the concerned contractor based on valid payment documents of respective revenue authority.
5. OGDCL shall withhold applicable income tax/PST/ICT as per prevailing withholding rules.
6. PST stands for provincial sale tax. ICT stands for Islamabad capital territory sale tax and PKR stand for Pakistan Rupees.

Contractor signature & official seal.

S.NO	DESCRIPTION OF WORK AND SPECIFICATION
1	Excavation any type of soil in RHC at site handed over to contractor.
2	Termite proofing in foundation, under floor, plinth protection of building including, wood work with approved chemical.
3	PCC 1:4:8 in foundations using crushed stone graded as specified in line and level as per drawings and specification etc.
4	Brick masonry using first class burnt bricks for foundation and up to ground floor roof level, brick masonry walls 115 mm thick, laid and jointed in 1:4 cm and over 115 mm thick, laid and jointed in 1:6 cement mortar.
5	Provision of RCC plinth band 9"x9" as per drawings with 1:2:4 concrete and 2 coat of hot bitumen 0.75kg per sq.m and blind with sand 0.012 cum per sq.m.
6	RCC 1:2:4 using crushed stone in columns/plinth beams, lintel bands, roof beams , roof slab 125 mm thick, including form work as specified ,reinforcement as per drawings or order by the Engineer in charge , ordinary Portland cement will be used, sand and aggregate shall be from approved source, compressive strength of concrete 1:2:4 after 28 days will be 3000 psi.
7	Steel reinforcement using deformed bars grade-60 including cutting ,bending ,binding, and placing reinforcement in position as per drawing and instruction of the engineer in charge.NO payment will be made for laps of steel or wastage. All tests of steel and concrete, cost born by the contractor.
8	Plinth protection 3.00' wide sub floor 3" thick PCC 1:4:8 and floor 3" thick of PCC 1:2:4, smooth finish with steel trowel.
9	PCC 1:4:8 ,4" thick sub floor and under layer of marble 1-1/2" thick 1:4 (cement mortar) and fixing marble (12"x24"x1" thick) (pure sunny white) as approved by the engineer in charge with jet black border, grouting with white neat cement including rubbing ,cutting and polishing etc.
10	Providing / fixing polyethylene water tank capacity 500.00 gallon with float valve and all fitting, pipes (PPR) valves, bends, tees, etc. and connecting with the existing water supply system, Running the water supply system complete in all respect.
11	Cement plaster 1/2" or 3/4" thick 1:4 on both sides wall (inner and outer) and RCC projection/parapet walls, ceiling, drips course etc.
12	Roof treatment, consist Two layer of bitumen 10/20 @ 4.90 kg/ 10sqm, with one primer coat over laying of polyethylene sheet 0.5mm, laying and compaction of average 4" thick earth over polyethylene sheet in required line and level and fixing 6"x12"x1 1/2" brick tiles with 1" mud mortar mixed with bhusa@ 10 kg per for 20 cft of earth. Filling the joint with 1:3 cement mortar, making khurra 12"x12" with cement concrete, average cross slop should not be less than 3".
13	Painting on all inner walls /ceiling, surface preparation and one coat of alkali resisting primer, preparing wall surface with putty of approved manufacture in three hands /coats and three coats of plastic emulsion paint ICI/Master or equivalent.

14	Painting on steel/iron/woods works, three coats of synthetic enamel ICI paint or equivalent with one coat of red oxide before applying paint all defects will be removed /rectified and cleaned thoroughly.
15	Three coat of weather resistant ICI/master paint or equivalent on exterior walls, before applying the weather resistant paint all defects must be removed / repaired etc.
16	(A) Aluminum sliding window anodized champagne colour (premium model) 6' height as per drawing including fixing on concrete wood, steel or brick masonry with all necessary fittings including glass 5mm thick tinted glass.(B) Providing fixing welded steel grill 4"x4" mesh with 1/2"x1/2" solid square bar with frame of 1 1/2"x1/4" steel putty or angel frame all around,1 coat of red oxide paint and 3 coat of enamel paint ICI/Master or equivalent, complete in all respect. Grill will be provided on all windows , ventilators and exhaust fans openings etc.
17	Supplying and fixing steel (GI) chokat press molded 16 swg for 115mm/230mm walls complete, including hold fast ties for vertical movement, PCC 1:2:4 cavity filling etc. Including 3 coat of enamel painting. Also fixing wooden beading/architrave both side of wall/door opening etc.
18	Providing and fixing of first class (Deodar wood) panel door, best quality 38mm thick with mortise lock ,best quality, tower bolt, hinges, Handel, including all necessary iron monger including sprit polishing. Wooden beading will be provided on both side of door fame. Using vertical style 5" bottom rail 8" lock rail 6" top rail 5".making four panel in each door, fixing each door with four hinges and mortise lock with one tower bolt and door stopper.
19	Construction of RCC slab for shelves 2"/3" thick for dispensary, using 3/8" main and 1/4" dia distribution bar fair face finished and 3 coat oil painting on shelves. Contactor will provide /construct sitting bench of concrete lined with ceramic tile 20" height 2' wide and 10' long 02 no's as per direction of Engineer in charge.
20	Providing fixing of pure sunny white marble counter top 14'x2'x1" in two pieces, including rubbing polishing etc as per drawing and instruction of the Engineer in charge.
21	Providing fixing of ceramic white tiles (prime quality) 12"x24" on all internal walls up to height of 6' in waiting and parking area of dispensary, store, bath room with cement or bond . Also providing ceramic tile on concrete sitting benches.
22	Plumbing work, tube water quality (PPR) with all fitting (i.e sockets, bends , tees , elbows where required) and laid complete in trenches, (including excavation) or fixed on wall , floor ,(concealed) including caps and plugs 25mm to 40mm as per site requirements with fusion system installation etc.
23	Providing /fixing master bathroom accessories set with mirror complete in all respect or equivalent.
24	Providing fixing of soil waste and vent pipe 100mm dia with all fittings, bends tees, as per site requirements. Also providing rain water pipe UPVC 4" dia with clamps bends 6 no's etc.

25	<p>(A) Water closet (W.C) Asiatic pattern white colour large size including footrest 13litter flushing cistern, low down flushing pipe etc.</p> <p>(B) Wash hand basin with pedestal (IFO Shape) 660mmx560mm glazed ware white colour, complete with waste pipe coupling, CP chain and plug with mixer best quality master or equivalent. Also providing 1 no double bib cock and Muslim shower for WC and one bib cock for general purpose in the bath room. Contactor will provide one bib cock chromium plated best quality, with ball wall in front of dispensary for washing of ambulance and watering of orchard.</p>
26	<p>Surface gullies (230mmx230mmx100mm outlet), man hole complete/ rectangular or circular as described, not exceeding 600mm deep from invert to surface of cover including main channel set in cement matter 1:1, two 230 mm thick brick walls, including man hole CI with frame, 450 mm, circular or rectangular exceeding 7.50kg each but not exceed 10kg each set in cement mortar and hunching in concrete.</p>
27	<p>Construction of 9"/13.5" thick brick masonry septic tank as per attached drawing 10'x5'x6' and 10' deep and 6' dia soakage pit, filled with brick bats, with vent pipe, soil pipe and cleaning gullies and manholes. No Payment will be made this item for this item, contractor is advised to incorporate cost of septic tank in the main building covered area rate.</p>
28	<p>Providing and fixing of main steel DB 12"x18"x16/18 swg powder coated with front glass & locking arrangement with following MCCB detail as:</p> <p>(A) Main double pole MCCB 63 amp 220 volt best quality one no.</p> <p>(B) 10 amp single pole best quality MCCB for distribution 4 no.</p> <p>(C) Providing fixing of volt meter and ampere meter on the DB.</p> <p>(D) Earthing the distribution board with coper 12mm dia rod, with 8 swg coper wire as per MES specification. Contractor will connect the DB with existings main hospital DB with 7/0.064 two core/ single core copper cable on his own expense, including excavation/back filling and making the surface good.</p>
29	<p>Wiring one fan point, one light point, one bell point, control by one switch wiring complete with PVC single core cable 3/0.029, in concealed PVC conduit, one three pin socket out let, 5A/15A, point controlled by one switch wiring complete with single core cable 7/0.029 in concealed PVC conduit as per drawing.</p>
30	<p>Providing fixing of led bulbs with holder 25 watts screw type as per drawing, contactor will provide 2 gang to 8 gang 10 amp switches as per drawing /site requirements. Dimmer will be provided for fan gang type, all ceiling fan will be 56" sweep best quality Pak fan, climax, Millat or equivalent, exhaust fan will be 12" in plastic body shutter pattern.</p>

31	<p>(A) Providing and fixing of 24volts automatic water prof solar light, power consumption SMD/LED system in 24 volt /2.1 A/50w, with 5 days back up time.</p> <p>(B) Deep cycle dry imported batteries 100 to 120 AH 2no and fixing of batteries on pool in well ventilated steel box for batteries with locking arrangement.</p> <p>(C) 2no solar panel 140watts polycrystalline with aluminum frame and system for installing on pole etc.</p> <p>(D) 20' high GI pole with base 12.5"x12.5" with Stiffeners, pole diameter from 6"to3" with foundation of PCC 1:2:4 3'x3'x3' all civil work complete in a respect.</p>
32	Specification for items, material will be adopted as per MES schedule of rates 2014/2015 as per drawing and as approved by the Engineer incharge,
33	All measurement will be made, for bill payment, from outer wall to outer wall no payment will be made for overhang, cantilever, sunshade, projection etc.
34	Providing fixing of steel gate with 2"x2"x1/4" angel frame and tee section with cross bracing as per drawing with 16swg MS sheet, with one coat of red oxide and three coat of oil painting, making door with all locking arrangements rolling type as per drawing and instruction of Engineer in charge.
35	<p>(A)(Providing and fixing of double face, 3" thick and 2' high jail on exterior walls of semi covered shed for ventilation and light, as per drawing and specification</p> <p>(B) P/F of steel gate of angle frame 2"x2"x1/4" and internal mesh of solid bar 1/2"x 1/2"(6"x6"mesh) welded with angel frame, with locks and locking arrangements painting with one coat of red oxide and three coat of enamel painting.</p> <p>(C) Ceramic tile 12"x24" will be provided on top of sitting shelf/concrete bench and up to height of 3' above shelf level.</p>
36	<p>Mode of payment</p> <p>(A) 30% payment on completion of brick masonry up to door level</p> <p>(B) 30% payment after RCC roof, installation of doors, windows and plaster</p> <p>(C) 40% payment on completion of project.</p> <p>(D) Solar light payment after installation / commissioning and running of light as per Engineer practice.</p>
37	Contractor will got prior approved of samples of, doors, aluminum window, tiles, bath room accessories, glass, marble tiles etc before incorporation/fixing in work.
38	Contractor is advised to visit the subjected site before submission of tender document to avoid any untoward situation.

SCHEDULE - B TO BID

SPECIFIC WORKS DATA

The work shall be as per contract agreement and in compliance to the BOQ, Drawings and Technical Specifications.

SCHEDULE – C TO BID

WORKS TO BE PERFORMED BY SUBCONTRACTORS

The bidder will do the work with his own forces except the work listed below which he intends to sub-contract.

Items of Works to be Sub-Contracted	Name and address of Sub-Contractors	Statement of similar works previously executed (attach evidence)
--	--	---

(DELETED)

Note:

1. No change of Sub-Contractors shall be made by the bidder without prior approval of the Employer.
2. The truthfulness and accuracy of the statement as to the experience of Sub-Contractors is guaranteed by the bidder. The Employer's judgment shall be final as to the evaluation of the experience of Sub-Contractors submitted by the bidder.
3. Statement of similar works shall include description, location & value of works, year completed and name & address of the clients.

SCHEDULE – D TO BID

PROPOSED PROGRAMME OF WORKS

Bidder shall provide a programme in a bar-chart showing the sequence of work items by which he proposes to complete the Works of the entire Contract. The programme should indicate the sequence of work items and the period of time during which he proposes to complete the Works including the activities like designing, schedule of submittal of drawings, ordering and procurement of materials, manufacturing, delivering, construction of civil works, erection, testing and commissioning of Works to be supplied under the Contract.

SCHEDULE – E TO BID

METHOD OF PERFORMING WORKS

The bidder is required to submit a narrative outlining the method of performing the Works. The narrative should indicate in detail and include but not be limited to:

- The sequence and methods in which he proposes to carry out the Works, including the number of shifts per day and hours per shift, he expects to work.
- A list of all major items of constructional and erectional plant, tools and vehicles proposed to be used in delivering/carrying out the Works at Site
- The procedure for installation of equipment and transportation of equipment and materials to the site.
- Organisation chart indicating head office & field office personnel involved in management, supervision and engineering of the Works to be done under the Contract.

SCHEDULE – F TO BID

(INTEGRITY PACT)

**DECLARATION OF FEES, COMMISSION AND BROKERAGE ETC.
PAYABLE BY THE SUPPLIERS OF GOODS, SERVICES & WORKS IN
CONTRACTS WORTH RS. 10.00 MILLION OR MORE**

Contract No. _____ Dated _____
Contract Value: _____
Contract Title: _____

..... [name of Supplier] hereby declares that it has not obtained or induced the procurement of any contract, right, interest, privilege or other obligation or benefit from Government of Pakistan (GoP) or any administrative subdivision or agency thereof or any other entity owned or controlled by GoP through any corrupt business practice.

Without limiting the generality of the foregoing, [name of Supplier] represents and warrants that it has fully declared the brokerage, commission, fees etc. paid or payable to anyone and not given or agreed to give and shall not give or agree to give to anyone within or outside Pakistan either directly or indirectly through any natural or juridical person, including its affiliate, agent, associate, broker, consultant, director, promoter, shareholder, sponsor or subsidiary, any commission, gratification, bribe, finder's fee or kickback, whether described as consultation fee or otherwise, with the object of obtaining or inducing the procurement of a contract, right, interest, privilege or other obligation or benefit in whatsoever form from GoP, except that which has been expressly declared pursuant hereto.

[name of Supplier] certifies that it has made and will make full disclosure of all agreements and arrangements with all persons in respect of or related to the transaction with GoP and has not taken any action or will not take any action to circumvent the above declaration, representation or warranty.

[name of Supplier] accepts full responsibility and strict liability for making any false declaration, not making full disclosure, misrepresenting facts or taking any action likely to defeat the purpose of this declaration, representation and warranty. It agrees that any contract, right, interest, privilege or other obligation or benefit obtained or procured as aforesaid shall, without prejudice to any other rights and remedies available to GoP under any law, contract or other instrument, be voidable at the option of GoP.

Notwithstanding any rights and remedies exercised by GoP in this regard, [name of Supplier] agrees to indemnify GoP for any loss or damage incurred by it on account of its corrupt business practices and further pay compensation to GoP in an amount equivalent to ten times the sum of any commission, gratification, bribe, finder's fee or kickback given by [name of Supplier] as aforesaid for the purpose of obtaining or inducing the procurement of any contract, right, interest, privilege or other obligation or benefit in whatsoever form from GoP.

Name of Buyer:
Signature:
[Seal]

Name of Seller/Supplier:
Signature:
[Seal]

Financial Details of The Firm
(To be attached with Technical Bid)

1. Name of The Firm /Company _____

2. PEC Category _____ valid upto _____

3. Company Name /Vendor Name _____
(As per Title of bank Account)

4. International Bank Account Number _____
(24 digits)

5. Bank Name _____

6. Branch Name & Address _____

7. National Tax Number _____

8. Postal Address _____

CONDITIONS OF CONTRACT

TABLE OF CONTENTS

CONDITIONS OF CONTRACT

<i>Clause No.</i>	<i>Description</i>	<i>Page No.</i>
1.	General Provisions	37
2.	The Employer	39
3.	Engineer's/Employer's Representatives	39
4.	The Contractor	40
5.	Design by Contractor	40
6.	Employer's Risks	41
7.	Time for Completion	42
8.	Taking Over	42
9.	Remedying Defects	43
10.	Variations And Claims	43
11.	Contract Price And Payment	44
12.	Default	46
13.	Risks And Responsibilities	47
14.	Insurance	48
15.	Resolution of Disputes	48
16.	Integrity Pact	49

CONDITIONS OF CONTRACT

1. GENERAL PROVISIONS

1.1 Definitions

In the Contract as defined below, the words and expressions defined shall have the following meanings assigned to them, except where the context requires otherwise:

The Contract

1.1.1 “Contract” means the Contract Agreement and the other documents listed in the Contract Data.

1.1.2 “Specifications” means the document as listed in the Contract Data, including Employer’s requirements in respect of design to be carried out by the Contractor (if any), and any Variation to such document.

1.1.3 “Drawings” means the Employer’s drawings of the Works as listed in the Contract Data, and any Variation to such drawings.

Persons

1.1.4 “Employer” means the person named in the Contract Data and the legal successors in title to this person, but not (except with the consent of the Contractor) any assignee.

1.1.5 “Contractor” means the person named in the Contract Data and the legal successors in title to this person, but not (except with the consent of the Employer) any assignee.

1.1.6 “Party” means either the Employer or the Contractor.

Dates, Times and Periods

1.1.7 “Commencement Date” means the date fourteen (14) days after the date the Contract comes into effect or any other date named in the Contract Data.

1.1.8 “Day” means a calendar day

1.1.9 “Time for Completion” means the time for completing the Works as stated in the Contract Data (or as extended under Sub-Clause 7.3), calculated from the Commencement Date.

Money and Payments

1.1.10 “Cost” means all expenditure properly incurred (or to be incurred) by the Contractor, whether on or off the Site, including overheads and similar charges but does not include any allowance for profit.

Other Definitions

- 1.1.11 “Contractor’s Equipment” means all machinery, apparatus and other things required for the execution of the Works but does not include Materials or Plant intended to form part of the Works.
- 1.1.12 “Country” means the Islamic Republic of Pakistan.
- 1.1.13 “Employer’s Risks” means those matters listed in Sub-Clause 6.1.
- 1.1.14 “Force Majeure” means an event or circumstance which makes performance of a Party’s obligations illegal or impracticable and which is beyond that Party’s reasonable control.
- 1.1.15 “Materials” means things of all kinds (other than Plant) to be supplied and incorporated in the Works by the Contractor.
- 1.1.16 “Plant” means the machinery and apparatus intended to form or forming part of the Works.
- 1.1.17 “Site” means the places provided by the Employer where the Works are to be executed, and any other places specified in the Contract as forming part of the Site.
- 1.1.18 “Variation” means a change which is instructed by the Engineer/Employer under Sub-Clause 10.1.
- 1.1.19 “Works” means any or all the works whether Supply, Installation, Construction etc. and design (if any) to be performed by the Contractor including temporary works and any variation thereof.
- 1.1.20 “Engineer” means the person notified by the Employer to act as Engineer for the purpose of the Contract and named as such in Contract Data.

1.2 Interpretation

Words importing persons or parties shall include firms and organisations. Words importing singular or one gender shall include plural or the other gender where the context requires.

1.3 Priority of Documents

The documents forming the Contract are to be taken as mutually explanatory of one another. If an ambiguity or discrepancy is found in the documents, the priority of the documents shall be in accordance with the order as listed in the Contract Data.

1.4 Law

The law of the Contract is the relevant Law of Islamic Republic of Pakistan.

1.5 **Communications**

All Communications related to the Contract shall be in English language.

1.6 **Statutory Obligations**

The Contractor shall comply with the Laws of Islamic Republic of Pakistan and shall give all notices and pay all fees and other charges in respect of the Works.

2. THE EMPLOYER

2.1 **Provision of Site**

The Employer shall provide the Site and right of access thereto at the times stated in the Contract Data.

2.2 **Permits etc.**

The Employer shall, if requested by the Contractor, assist him in applying for permits, licences or approvals which are required for the Works.

2.3 **Engineer's/Employer's Instructions**

The Contractor shall comply with all instructions given by the Employer or the Engineer, if notified by the Employer, in respect of the Works including the suspension of all or part of the Works.

2.4 **Approvals**

No approval or consent or absence of comment by the Engineer/Employer shall affect the Contractor's obligations.

3. ENGINEER'S/EMPLOYER'S REPRESENTATIVES

3.1 **Authorised Person**

The Employer shall appoint a duly authorized person to act for him and on his behalf for the purposes of this Contract. Such authorized person shall be duly identified in the Contract Data or otherwise notified in writing to the Contractor as soon as he is so appointed. In either case the Employer shall notify the Contractor, in writing, the precise scope of the authority of such authorized person at the time of his appointment.

3.2 **Engineer's/Employer's Representative**

The name and address of Engineer's/Employer's Representative is given in Contract Data. However the Contractor shall be notified by the

Engineer/Employer, the delegated duties and authority before the Commencement of Works.

4. THE CONTRACTOR

4.1 General Obligations

The Contractor shall carry out the Works properly and in accordance with the Contract. The Contractor shall provide all supervision, labour, Materials, Plant and Contractor's Equipment which may be required.

4.2 Contractor's Representative

The Contractor shall appoint a representative at site on full time basis to supervise the execution of work and to receive instructions on behalf of the Contractor but only after obtaining the consent of the Employer for such appointment which consent shall not be unreasonable withheld by the Employer. Such authorized representative may be substituted/replaced by the Contractor at any time during the Contract Period but only after obtaining the consent of the Employer as aforesaid.

4.3 Subcontracting

The Contractor shall not subcontract the whole of the Works. The Contractor shall not subcontract any part of the Works without the consent of the Employer.

4.4 Performance Security

Contractor shall furnish to the Employer within fourteen (14) days after receipt of Letter of Acceptance a Performance Security 10% of contract price, at the option of the bidder, in the shape of Bank Draft/Call Deposit/Pay Order or Bank Guarantee .with the validity as specified in Contract Data. Bank Guarantee as performance security must be submitted in accordance with the format provided in tender documents Performance security in the form of bank guarantee will not be acceptable with the banks whose market price per share /is quoted below the Par Value at Stock Exchange. Crossed cheque/insurance guarantee. Swift Message will not be acceptable.

5. DESIGN BY CONTRACTOR

5.1 Contractor's Design

The Contractor shall carry out design to the extent specified, as referred to in the Contract Data. The Contractor shall promptly submit to the Engineer/Employer all designs prepared by him. Within fourteen (14) days of receipt the Engineer/Employer shall notify any comments or, if the design submitted is not in accordance with the Contract, shall reject it stating the reasons. The Contractor shall not construct any element of the Works designed by him within fourteen (14) days after the design has been submitted to the Engineer/Employer or which has been rejected. Design that has been rejected shall be promptly amended and resubmitted. The Contractor shall resubmit all designs commented on taking these comments into account as necessary.

5.2 **Responsibility for Design**

The Contractor shall remain responsible for his bided design and the design under this Clause, both of which shall be fit for the intended purposes defined in the Contract and he shall also remain responsible for any infringement of any patent or copyright in respect of the same.

6. **EMPLOYER'S RISKS**

6.1 **The Employer's Risks**

The Employer's Risks are:-

- a) war, hostilities (whether war be declared or not), invasion, act of foreign enemies, within the Country;
- b) rebellion, terrorism, revolution, insurrection, military or usurped power, or civil war, within the Country;
- c) riot, commotion or disorder by persons other than the Contractor's personnel and other employees including the personnel and employees of Sub-Contractors, affecting the Site and/or the Works;
- d) ionising radiations, or contamination by radio-activity from any nuclear fuel, or from any nuclear waste from the combustion of nuclear fuel, radio-active toxic explosive, or other hazardous properties of any explosive nuclear assembly or nuclear component of such an assembly, except to the extent to which the Contractor/Sub-Contractors may be responsible for the use of any radio-active material;
- e) Pressure waves caused by aircraft or other aerial devices travelling at sonic or supersonic speeds;
- f) use or occupation by the Employer of any part of the Works, except as may be specified in the Contract;
- g) late handing over of sites, anomalies in drawings, late delivery of designs and drawings of any part of the Works by the Employer's personnel or by others for whom the Employer is responsible;
- h) a suspension under Sub-Clause 2.3 unless it is attributable to the Contractor's failure; and
- i) physical obstructions or physical conditions other than climatic conditions, encountered on the Site during the performance of the Works, for which the Contractor immediately notified to the Employer and accepted by the Employer.

7. **TIME FOR COMPLETION**

7.1 **Execution of the Works**

The Contractor shall commence the Works on the Commencement Date and shall proceed expeditiously and without delay and shall complete the Works, subject to Sub-Clause 7.3 below, within the Time for Completion.

7.2 **Programme**

Within the time stated in the Contract Data, the Contractor shall submit to the Engineer/Employer a programme for the Works in the form stated in the Contract Data.

7.3 **Extension of Time**

The Contractor shall, within such time as may be reasonable under the circumstances, notify the Employer/Engineer of any event(s) falling within the scope of Sub-Clause 6.1 or 10.3 of these Conditions of Contract and request the Employer/Engineer for a reasonable extension in the time for the completion of Works. Subject to the aforesaid, the Employer/Engineer shall determine such reasonable extension in the time for the completion of Works as may be justified in the light of the details/particulars supplied by the Contractor in connection with the such determination by the Employer/Engineer within such period as may be prescribed by the Employer/Engineer for the same; and

the Employer shall extend the Time for Completion as determined.

7.4 **Late Completion**

If the Contractor fails to complete the Works within the Time for Completion, the Contractor's only liability to the Employer for such failure shall be to pay the amount stated in the Contract Data for each day for which he fails to complete the Works.

8. **TAKING-OVER**

8.1 **Completion**

The Contractor may notify the Engineer/Employer when he considers that the Works are complete.

8.2 **Taking-Over Notice**

Within fourteen (14) days of the receipt of the said notice of completion from the Contractor the Employer/Engineer shall either takeover the completed Works and issue a Certificate of Completion to that effect or shall notify the Contractor his reasons for not taking-over the Works. While issuing the Certificate of Completion as aforesaid, the Employer/Engineer may identify any outstanding items of work which the Contractor shall undertake during the Maintenance Period.

9. REMEDYING DEFECTS

9.1 Remediating Defects

The Contractor shall for a period stated in the Contract Data from the date of issue of the Certificate of Completion carry out, at no cost to the Employer, repair and rectification work which is necessitated by the earlier execution of poor quality of work or use of below specifications material in the execution of Works and which is so identified by the Employer/Engineer in writing within the said period. Upon expiry of the said period, and subject to the Contractor's faithfully performing his aforesaid obligations, the Employer/Engineer shall issue a Maintenance Certificate whereupon all obligations of the Contractor under this Contract shall come to an end.

Failure to remedy any such defects or complete outstanding work within a reasonable time shall entitle the Employer to carry out all necessary works at the Contractor's cost. However, the cost of remedying defects not attributable to the Contractor shall be valued as a Variation.

9.2 Uncovering and Testing

The Engineer/Employer may give instruction as to the uncovering and/or testing of any work. Unless as a result of an uncovering and/or testing it is established that the Contractor's design, Materials, Plant or workmanship are not in accordance with the Contract, the Contractor shall be paid for such uncovering and/or testing as a Variation in accordance with Sub-Clause 10.2.

10. VARIATIONS AND CLAIMS

10.1 Right to Vary

The Employer/Engineer may issue Variation Order(s) in writing. Where for any reason it has not been possible for the Employer/Engineer to issue such Variations Order(s), the Contractor may confirm any verbal orders given by the Employer/Engineer in writing.

10.2 Valuation of Variations

Variations shall be valued as follows:

- a) at a lump sum price agreed between the Parties, or
- b) where appropriate, at rates in the Contract, or
- c) in the absence of appropriate rates, the rates in the Contract shall be used as the basis for valuation, or failing which
- d) at appropriate new rates, as may be agreed or which the Engineer/Employer considers appropriate, or

- e) if the Engineer/Employer so instructs, at rates set out in the Contract Data.

10.3 **Early Warning**

The Contractor shall notify the Engineer/Employer in writing as soon as he is aware of any circumstance which may delay or disrupt the Works, or which may give rise to a claim for additional payment.

To the extent of the Contractor's failure to notify, which results to the Engineer/Employer being unable to keep all relevant records or not taking steps to minimise any delay, disruption, or Cost, or the value of any Variation, the Contractor's entitlement to extension of the Time for Completion or additional payment shall be reduced/rejected.

10.4. **Valuation of Claims**

If the Contractor incurs Cost as a result of any of the Employer's Risks, the Contractor shall be entitled to the amount of such Cost. If as a result of any Employer's Risk, it is necessary to change the Works, this shall be dealt with as a Variation subject to Contractor's notification for intention of claim to the Engineer/Employer within fourteen (14) days of the occurrence of cause.

10.5 **Variation and Claim Procedure**

The Contractor shall submit to the Engineer/Employer an itemised make-up of the value of variations and claims within twenty eight (28) days of the instruction or of the event giving rise to the claim. The Engineer/Employer shall check and if possible agree the value. In the absence of agreement, the Employer shall determine the value.

11. **CONTRACT PRICE AND PAYMENT**

11.1 (a) **Terms of Payments**

The amount due to the Contractor under any Interim Payment Certificate issued by the Engineer pursuant to this Clause, or to any other terms of the Contract, shall , subject to Clause 7.4, be paid by the Employer to the Contractor within 30 days after receipt of such Interim Payment Certificate from the Engineer, or, in the case of the Final Certificate, within 60 days after receipt of such Final Payment Certificate from the Engineer.

(b) **Valuation of the Works**

The Works shall be valued as provided for in the Contract Data, subject to Clause 10.

11.2 **Monthly Statements**

The Contractor shall be entitled to be paid at monthly intervals:

- a) the value of the Works executed; and
- b) The percentage of the value of Materials and Plant reasonably delivered to the Site, as stated in the Contract Data, subject to any additions or deductions which may be due.

The Contractor shall submit each month to the Engineer/Employer a statement showing the amounts to which he considers himself entitled.

11.3 **Interim Payments**

Within a period not exceeding Fourteen (14) days from the date of submission of a statement for interim payment by the Contractor, the Engineer shall verify the same. The employer, within a period not exceeding thirty (30) days from receipt of such interim payment certificate from the Engineer, will pay such sum verified by the Engineer less retention money at the rate stated in the Contract Data.

11.4 **Retention**

Retention money shall be paid by the Employer to the Contractor within manner stated in Contract Data after either the expiry of the defects liability period stated in the Contract Data, or the remedying of notified defects, or the completion of outstanding work, all as referred to in Sub-Clause 9.1, which ever is the later.

11.5 **Final Payment**

Within twenty one (21) days from the date of issuance of the Completion / Taking Over Certificate the Contractor shall submit a final account to the Engineer to verify and the Engineer shall verify the same within thirty (30) days from the date of submission and forward the same to the Employer together with any documentation reasonably required to enable the Employer to ascertain the final contract value.

Within sixty (60) days from the date of receipt of the verified final account from the Engineer, the Employer shall pay to the Contractor any amount due to the Contractor. While making such payment the Employer may, for reasons to be given to the Contractor in writing, withhold any part or parts of the verified amount.

11.6 **Currency**

Payment shall be in the currency stated in the Contract Data.

12. **DEFAULT**

12.1 **Default by Contractor**

If the Contractor abandons the Works, refuses or fails to comply with a valid instruction of the Engineer/Employer or fails to proceed expeditiously and without

delay, or is, despite a written complaint, in breach of the Contract, the Employer may give notice referring to this Sub-Clause and stating the default.

If the Contractor has not taken all practicable steps to remedy the default within fourteen (14) days after receipt of the Employer's notice, the Employer may by a second notice given within a further twenty one (21) days, terminate the Contract. The Contractor shall then demobilise from the Site leaving behind any Contractor's Equipment which the Employer instructs, in the second notice, to be used for the completion of the Works at the risk and cost of the Contractor.

12.2 **Default by Employer**

If the Employer fails to pay in accordance with the Contract, or is, despite a written complaint, in breach of the Contract, the Contractor may give notice referring to this Sub-Clause and stating the default. If the default is not remedied within fourteen (14) days after the Employer's receipt of this notice, the Contractor may suspend the execution of all or parts of the Works.

If the default is not remedied within twenty eight (28) days after the Employer's receipt of the Contractor's notice, the Contractor may by a second notice given within a further twenty one (21) days, terminate the Contract. The Contractor shall then demobilise from the Site.

12.3 **Insolvency**

If a Party is declared insolvent under any applicable law, the other Party may by notice terminate the Contract immediately. The Contractor shall then demobilise from the Site leaving behind, in the case of the Contractor's insolvency, any Contractor's Equipment which the Employer instructs in the notice is to be used for the completion of the Works.

12.4 **Payment upon Termination**

After termination, the Contractor shall be entitled to payment of the unpaid balance of the value of the Works executed and of the Materials and Plant reasonably delivered to the Site, adjusted by the following:

- a) any sums to which the Contractor is entitled under Sub-Clause 10.4,
- b) any sums to which the Employer is entitled,
- c) if the Employer has terminated under Sub-Clause 12.1 or 12.3, the Employer shall be entitled to a sum equivalent to twenty percent (20%) of the value of parts of the Works not executed at the date of the termination, and
- d) if the Contractor has terminated under Sub-Clause 12.2 or 12.3, the Contractor shall be entitled to the cost of his demobilisation together with a sum equivalent to ten percent (10%) of the value of parts of the Works not executed at the date of termination.

The net balance due shall be paid or repaid within twenty eight (28) days of the

notice of termination.

13. RISKS AND RESPONSIBILITIES

13.1 Contractor's Care of the Works

Subject to Sub-Clause 9.1, the Contractor shall take full responsibility for the care of the Works from the Commencement Date until the date of the Employer's/Engineer's issuance of Certificate of Completion under Sub-Clause 8.2. Responsibility shall then pass to the Employer. If any loss or damage happens to the Works during the above period, the Contractor shall rectify such loss or damage so that the Works conform with the Contract.

Unless the loss or damage happens as a result of any of the Employer's Risks, the Contractor shall indemnify the Employer, or his agents against all claims loss, damage and expense arising out of the Works.

13.2 Force Majeure

If Force Majeure occurs, the Contractor shall notify the Engineer/Employer immediately. If necessary, the Contractor may suspend the execution of the Works and, to the extent agreed with the Employer demobilise the Contractor's Equipment.

If the event continues for a period of eighty four (84) days, either Party may then give notice of termination which shall take effect twenty eight (28) days after the giving of the notice.

After termination, the Contractor shall be entitled to payment of the unpaid balance of the value of the Works executed and of the Materials and Plant reasonably delivered to the Site, adjusted by the following:

- a) any sums to which the Contractor is entitled under Sub-Clause 10.4,
- b) the cost of his demobilization, and
- c) less any sums to which the Employer is entitled.

The net balance due shall be paid or repaid within thirty five (35) days of the notice of termination.

14. INSURANCE

14.1 Arrangements

The Contractor shall, prior to commencing the Works, effect insurances of the types, in the amounts and naming as insured the persons stipulated in the Contract Data except for items (a) to (e) and (i) of the Employer's Risks under Sub-Clause 6.1. The policies shall be issued by insurers and in terms approved by the Employer. The Contractor shall provide the Engineer/Employer with evidence that

any required policy is in force and that the premiums have been paid.

14.2 **Default**

If the Contractor fails to effect or keep in force any of the insurances referred to in the previous Sub-Clause, or fails to provide satisfactory evidence, policies or receipts, the Employer may, without prejudice to any other right or remedy, effect insurance for the cover relevant to such as a default and pay the premiums due and recover the same plus a sum in percentage given in Contractor Data from any other amounts due to the Contractor.

15. **RESOLUTION OF DISPUTES**

15.1 **Engineer's Decision**

If a dispute of any kind whatsoever arises between the Employer and the Contractor in connection with the Works, the matter in dispute shall, in the first place, be referred in writing to the Engineer, with a copy to the other party. Such reference shall state that it is made pursuant to this Clause. No later than the twenty eight (28) days after the day on which he received such reference, the Engineer shall give notice of his decision to the Employer and the Contractor.

Unless the Contract has already been repudiated or terminated, the Contractor shall, in every case, continue to proceed with the Work with all due diligence, and the Contractor and the Employer shall give effect forthwith to every such decision of the Engineer unless and until the same shall be revised, as hereinafter provided in an arbitral award.

15.2 **Notice of Dissatisfaction**

If a Party is dissatisfied with the decision of the Engineer or if no decision is given within the time set out in Sub-Clause 15.1 hereabove, the Party may give notice of dissatisfaction referring to this Sub-Clause within fourteen (14) days of receipt of the decision or the expiry of the time for the decision. If no notice of dissatisfaction is given within the specified time, the decision shall be final and binding on the Parties. If notice of dissatisfaction is given within the specified time, the decision shall be binding on the Parties who shall give effect to it without delay unless and until the decision of the Engineer is revised by an arbitrator.

15.3 **Arbitration**

A dispute which has been the subject of a notice of dissatisfaction shall be finally settled as per provisions of Arbitration Act 1940 (Act No. X of 1940) and Rules made thereunder and any statutory modifications thereto. Any hearing shall be held at the place specified in the Contract Data and in the language referred to in Sub-Clause 1.5.

16 **INTEGRITY PACT**

16.1 If the Contractor, or any of his Sub-Contractors, agents or servants is found to have violated or involved in violation of the Integrity Pact signed by the Contractor as Schedule-F to his Bid, then the Employer shall be entitled to:

(a) recover from the Contractor an amount equivalent to ten times the sum of any commission, gratification, bribe, finder's fee or kickback given by the Contractor or any of his Sub-Contractors, agents or servants;

(b) terminate the Contract; and

(c) recover from the Contractor any loss or damage to the Employer as a result of such termination or of any other corrupt business practices of the Contractor or any of his Sub-Contractors, agents or servants.

On termination of the Contract under Sub-Para (b) of this Sub-Clause, the Contractor shall demobilize from the Site leaving behind Contractor's Equipment which the Employer instructs, in the termination notice, to be used for the completion of the Works at the risk and cost of the Contractor. Payment upon such termination shall be made under Sub-Clause 12.4, in accordance with Sub-Para (c) thereof, after having deducted the amounts due to the Employer under Sub-Para (a) and (c) of this Sub-Clause.

CONTRACT DATA

Sub-Clauses of Conditions of Contract

- 1.1.3 **Employer's Drawings, if any**
Drawings as attached with bid documents.
- 1.1.4 **The Employer** means
Oil & Gas Development Company Limited, Islamabad, Pakistan.
- 1.1.5 **The Contractor** means
The bidders whose tender for this work has been accepted, contract executed with,
and work order issued to.
- 1.1.7 **Commencement Date** means the date 07 days after the possession of site handed
over to the contractor or the date of physical commencement of works by the
contractor, whichever is earlier.
- 1.1.9 **Time for Completion** (120 Days)
The time for completion of the work is as mentioned in the Press advertisement.
- 1.1.20 **Engineer**
As nominated in the Work Order.
- 1.3 **Documents forming the Contract listed in the order of priority:**
- (a) The Contract Agreement
 - (b) Letter of Acceptance
 - (c) The completed Form of Bid
 - (d) Contract Data
 - (e) Conditions of Contract
 - (f) The completed Schedules to Bid including Schedule of Prices
 - (g) The Drawings, if any
 - (h) The Specifications
 - (i) Any other documents _____
- 2.1 **Provision of Site:** According to Commencement Date or as per required procedure
of OGDCL.
- 3.1 **Authorised person :** As mentioned in the work order.
- 3.2 **Name and address of Engineer's/Employer's representative** As per Work Order or
thereafter by nominated Engineer / Engineer-in-Charge.

The Engineer shall obtain the specific approval of the Employer before carrying out
his duties in accordance with the provisions of contract agreement but not limited to
the following:

- (i) Consenting to the sub-letting of any part of the Works.
- (ii) Certifying additional cost determined due to “Not Foreseeable Physical Obstructions or Conditions”.
- (iii) Any action related to “Performance Security” and Insurance of all sorts.
- (iv) Any action for “Suspension”.
- (v) Any action for “Extension of Time for Completion”.
- (vi) Any action for “Liquidated Damages for Delay”.
- (vii) Issuance of “Taking Over Certificate”.
- (viii) Issuing a Variation Order
- (ix) Fixing rates or prices for valuation of contract price / additional items.
- (x) Extra payment as a result of Contractor’s claims.
- (xi) Release of Retention Money to the Contractor “Payment of Retention Money”.
- (xii) Issuance of “Final Payment Certificate”.
- (xiii) Issuance of “Defect Liability Certificate”.
- (xiv) Any change in the ratios of Contract currency proportions and payments thereof related to Currency and Rate of Exchange”.

4.4 **Performance Security:** .

Contractor shall furnish to the Employer within fourteen (14) days after receipt of Letter of Acceptance a Performance Security 10% of contract price, at the option of the bidder, in the shape of Bank Draft/Call Deposit/Pay Order or Bank Guarantee .with the validity as specified in Contract Data. Bank Guarantee as . performance security must be submitted in accordance with the format provided in tender documents Performance security will not be acceptable with the banks whose market price per share /is quoted below the Par Value at Stock Exchange Crossed Cheque/Insurance Guarantee .Swift Message will not be acceptable .

5.1 **Requirement for Contractor's design (if any)**

Design of no part of work is required at contractor's part and unless stated in the schedule of prices.

6.1 **The Employer’s Risks**

The Employer’s risks are: (51)

Not withstanding anything contained (in Conditions of Contract 6.1), the Employer

shall not be responsible, compensate or bear any kind of risk/liability whatsoever in nature.

7.2 **Programme:**

Time for submission: Within Seven (07) days after the Commencement Date.

Form of programme: (Bar Chart/CPM as advised by The Engineer)

7.4 Amount payable due to failure to complete shall be 0.1% per day up to a maximum of (10%) of sum stated in the Letter of Acceptance / contract price.

9.1 **Period for remedying defects**

365 calendar days after the completion date as mentioned in completion / taking over certificate.

10.2 (e) **Variation procedure:**

MES Schedule of rates 2014 (reprinted in 2015) with applicable premium.

10.4. **Valuation of Claims**

This clause is deleted.

11.1 (a) **Terms of Payments**

The Engineer on behalf of the employer under clause No. 3.1, shall jointly, with the contractor, verify interim payment certificate and process in 14 days from the receipt of such interim payment certificate from the contractor. For Final Payment certificate this period shall be 30 days.

11.1 (b) **Valuation of the Works:**

The quantities set out in the schedule of price are the estimated quantities for the Works, and they are not to be taken as the actual and correct quantities of the Works to be executed by the Contractor in fulfillment of his obligations under the Contract. The Engineer shall ascertain and determine by measurement the value of the actual Work done in accordance with the Contract and the Contractor shall be paid that value in accordance with this Clause.

Should the Contractor not attend, or neglect or omit to send his representative, then the measurement made by the Engineer or approved by him shall be taken to be the correct measurement of such part of the Works.

11.2 (b) **Percentage of value of Materials and Plant:**

This sub clause is deleted in its entirety.

11.3 & 11.4 **Retention Money:**

Retention Money shall be retained @ 10% of Interim Payment Certificates with maximum limit @ 05 % of the Contract Price. Upon the issue of the Taking-Over / Completion Certificate with respect to the whole of the Works, one half

of the Retention Money shall be certified by the Engineer for payment to the Contractor. Upon the expiration of the Defects Liability Period for the Works the other half of the Retention Money shall be certified by the Engineer for payment to the Contractor. Provided also that if at such time, there shall remain to be executed by the Contractor any work instructed, pursuant to Clause 9.1, in respect of the Works, the Engineer shall be entitled to withhold certification until completion of such work of so much of the balance of the Retention Money as shall, in the opinion of the Engineer, represent the cost of the work remaining to be executed.

11.6 **Currency of payment:** Pak. Rupees.

12.2 **Default by Employer**
This clause is deleted in its entirety.

14.1 **Insurances:**

Type of cover

The Works

Amount of cover

The sum stated in the Letter of Acceptance plus fifteen percent (15%)

Type of cover

Contractor's Equipment:

Amount of cover

Full replacement cost

Type of cover

Third Party-injury to persons and damage to property

Rs.500,000/- for each occurrence with unlimited no of occurrences.

(The minimum amount of third party insurance should be assessed by the Employer and entered).

Workers:

Rs.500,000/-

For each occurrence.

(In each case name of insured is Contractor and Employer)

14.2 Amount to be recovered

Premium plus Twenty percent (20 %).

15.3 Arbitration

Place of Arbitration: Islamabad.

16. Bid Security

. In case the bidder fails to fulfill agreed Tender/contract terms & Condition by submitting Forged documents and based on forged documents he is declared Lowest Evaluated Responsive Bidder and these documents are noticed during execution of work , the bidder shall be liable to pay liquidated damages as per Terms and mechanism agreed in the tender . Whereany loss or damaged suffered by OGDCL due to any of aforementioned act of the bidder is more than the liquidated damages , the company will be entitled to mitigate /recover the losses through encashment of Bank Guarantee /Bid securities / Earnest money or Forfeiture of security furnished by bidder in other procuremnet cases .

17. BLACK LISTING OF SUPPLIERS:-

Blacklisting means; temporarily or permanently, barring an entity or a person against whom proceedings have been initiated including but not limited to bidder, contractor, supplier, agent, consultant, company, partnership, company or firm; hereinafter referred to as, Respondent from participating in any future procurement (goods & services) proceedings conducted by OGDCL. The Respondent(s) individually or collectively as a consortium may stand blacklisted if found to have been involved in any or all of the following acts:

A) Undermines or adversely affects the operations of the company through wilful failure by:

- a) Withdrawing a bid during the bid validity period;
- b) Failure or refusal to:
 - i. sign the contract;
 - ii. accept Purchase Order / Service Order Terms;
 - iii. execute work;
 - iv. submit Bank Guarantee as per tender terms;
 - v. make supplies as per specification agreed;
 - vi. fulfill contractual obligations as per contract;
 - vii. meet purchase order / service order terms and conditions; and/or,
 - viii. to remedy underperformance as per contractual obligations.
 - ix. Or any other non-compliance of obligations vital for the execution / compliance of the contract.
- c) Repeated non-performance.

B) Indulgences in corrupt or fraudulent practices while obtaining or attempting to obtain contracts in the company.

C). Convicted of fraud, corruption, tax evasion or criminal misappropriation by a court of competent forum.

D). Notified blacklisted/debarred/cross debarred by any public sector organization or international agency. (Note: At the time of submission of bid

a contractor shall submit an Affidavit Form 4 that he or his principal is not declared blacklisted / debarred / cross debarred by any public sector organization or international agency.)

E) Furnished information that was false and materially inaccurate or submitted forged or fake documents.

18. CONFISCATION OF BANK GUARANTEE / PAY ORDER / DEMAND DRAFT ETC.:-

The bank guarantee / bid bond (earnest money) / performance bond / Advance Bank Guarantees etc. of the bidder/vendor will be confiscated if they:

- i- Withdraw their bid during bid validity.
Or
- ii- Fails to provide performance and/or advance bank guarantees.
Or
- iii- Submit forged document in support of their bid.
Or
- iv- Fails to execute contract as per terms of contract.
Or
- v- Fails to supply the short/wrong shipped items
Or
- vi- Any other reason warranting the confiscation of the guarantee.

Detailed Technical Evaluation Criteria

- i. **Firm's Registration with PEC.** - **10 marks.**
The contractor shall have valid registration with PEC for the current year.
- a. Valid registration of the firm - 10 marks.
b. Invalid Registration - 0 marks / Non-responsive

- ii. **Audited Accounts for last three years.** - **30 marks**
- a. Average Annual Turn Over of last three year, if 03 times the estimated cost of this project - 30 marks.
b. Average Annual Turn Over of last three year, if 02 times the estimated cost of this project - 20 marks
c. Average Annual Turn Over of last three year, if equal to estimated cost of this project - 10 marks.
d. Average annual Turnover of last three years if less than estimated cost of this project - 0 Marks/Non-responsive
e. Marks will be awarded on pro rata basis where average annual turnover of last 03 years is more than estimated cost.

.....iii. **General Experience** -%\$ marks

Ten (10) No of Works will be considered for evaluation. Each work carry equal marks. project whose work order or completion certificates are available shall be considered for evaluation. Date, Contact Nos, address, Name and signature of issuing authority shall be clearly mentioned on work order and completion certificates.

.....iv. **Relevant Experience** -30 marks

Three (03) No of similar nature projects with contract price equal to or more than 75 % of estimated cost will be considered for evaluation. Project whose work order and completion certificates are available, and executed during last 15 years, shall be considered for evaluation. Date, Contact Nos, address, Name and signature of issuing authority shall be clearly mentioned on work order and completion certificates. Each project shall carry equal marks.

.....v. **List of Machinery, Tools & Plants.** -0) marks

Bidder will provide list of Machinery, Tool and Plants, to be provided for this work duly on stamp paper attested by Notary Public, as per requirement of work and ensure availability of such machinery as per instruction of Engineer In charge during execution at site. It will be responsibility of contractor to arrange such machinery on as and when required basis through lease or owned resources during execution of work.

List of Machinery shall meet requirements of this project.
Technical Evaluation Committee will determine requirements of machinery for this project and evaluate all bidders as under:-

- a. List of Machinery meeting all requirements of Machinery, Tools & Plants - 05 marks.
 - b. Committee may give marks less than the maximum, based on the actual machinery, tools and plants of the bidder if it is less than the requirement of the this project. - By Committee.
 - c. List of Machinery not meeting requirement of Machinery, Tools & Plants - 0 marks
- vi. List of relevant Qualified Staff (Detailed CVs required) - 10 marks.**

Detailed CVs of personnel, mentioning work experience, educational details , PEC registration Nos, Bio data & other /required information for evaluation purpose , Copy of PEC registration certificate may be attached .

- a. Meeting minimum requirements of engineers for requisite PEC category - 10 Marks
- b. Committee may give marks less than the maximum, if no of engineers is less than requisite PEC category - By Committee
- c. Not meeting requirement of relevant qualified - 0 Marks.

vii. HSE, QC & QA policy of the firm

- a. Provided - 05 marks.
- b. Not provided - 0 marks.

STANDARD FORMS

SPECIMEN OF BANK GUARANTEE AS BID SECURITY/BID BOND/EARNEST MONEY

Guarantee # : _____
 Date of Issue : _____
 Date of Expiry : _____
 Amount : _____

OIL AND GAS DEVELOPMENT COMPANY LIMITED
 Supply Chain Management Department
 OGDCL House, Jinnah Avenue,
Islamabad.

In consideration of _____ hereinafter called "THE BIDDER" HAVING SUBMITTED THE ACCOMPANYING Bid against Tender No. _____ and in consideration of value received from (the bidder above), we hereby agree to undertake as follows:

1. To make unconditional payment of Rs. _____ (Rupees _____) up on your written demand without further recourse, question or reference to the BIDDER or any other person in the specified Bid after opening of the same for the validity thereof or if no such period be specified, within 150 days after the said opening or if the Bidder, having been notified of the acceptance of his bid by the Purchaser during the period of bid validity:
 - a) Fails to execute Purchase Order and/or Contract in accordance with the tender document, **OR**
 - b) Fails or refuses to furnish Performance Bond in accordance with tender document, **OR**
 - c) withdraws its bid during the period of bid validity, **OR**
 - d) If the documents are found forged at any stage, **OR**
 - e) Fails to supply the short/wrong shipped items or any other reason warranting the forfeiture.
2. To accept written intimation(s) from you as conclusive and sufficient evidence of the existence of a default or non-compliance as aforesaid on the part of the BIDDER and to make payment accordingly within 03 (three) days of receipt of the written intimation.
3. No grant of time or other indulgence to or composition or arrangement with the Bidder in respect of aforesaid Bid with or without notice to us shall affect this Guarantee and our liabilities and commitments hereunder.
4. This guarantee shall be binding on us and our successors in interest and shall be irrevocable.

(BANKER)

SPECIMEN OF BANK GUARANTEE AS PERFORMANCE BOND

Guarantee # _____
Date of Issue: _____
Date of Expiry: _____
Amount: _____

OIL AND GAS DEVELOPMENT COMPANY LIMITED

Supply Chain Management Department
OGDCL House, Jinnah Avenue,
Islamabad.

In consideration of your issuance of Local Purchase Order and/or Contract No _____ to M/s _____ called supplier and/or Contractor and in consideration of value received from supplier and/or Contractor we (Please mention name of Bank) at the request of M/s _____ (Please mention name of supplier and/or contractor) hereby agree and undertake as:

1. To make unconditional payments to you as called upon 10% of the value of the LPO and/or contract (Please mention amount of guarantee in words and figure) mentioned in the said LPO and/or Contract on your return demands without further recourse, question or reference to supplier and/or contractor or any other person in the event of default, non-performance or non-fulfilment by supplier and/or contractor of his obligations, liabilities, responsibilities or any of the following reasons under the said LPO and/or contract which you shall be the soul judge :
 - a) Fails to provide Advance Bank Guarantee (where applicable).
 - b) Submit forged document in support of their bid.
 - c) Fails to execute Purchase Order and/or Contract in accordance with the terms and condition of the tender document/LPO/Contract
 - d) Fails to supply the short/wrong shipped items.
 - e) Any other reason warranting the confiscation of the Guarantee.
2. To accept return intimation from you as conclusive and sufficient evidence of existence if a default or breach as aforesaid on the part of supplier and/or Contractor and to make payment accordingly within 03 (three) days of receipt thereof.
3. To keep the guarantee in full force from the date hereof until 30 (Thirty) days from the Date of Delivery of last consignment of material at given destination as per LPO and/or contract.
4. To keep 50% amount of this guarantee, enforce from the date hereof until 12 months from the date of delivery of last consignment of the material at a given destination as per LPO and/or Contract.
5. That no grant of time or other indulgence to, amendment in terms of LPO and/or contract by agreement between the parties or imposition or agreement with LPO and/or Contract in respect of the performance of this obligations under the said agreement , with or without notice to us shall in any manner discharged or otherwise affect this guarantee and our liabilities and commitments their under.
6. This guarantee shall be binding on us and our successors in interest and shall be irrevocable.
7. This guarantee shall not be affected by any change in the constitutions of the guarantor Bank or the supplier and/or contractor.

(BANKER)

Note: The PBG should be valid for 100% value to cover the delivery of the last consignment/ completion of project whichever is later plus 08 weeks*. Accordingly, 50% of PBG must be valid for further one year.

*08 weeks are required to cover the period for authenticity of PBG, inspection and clearance period and minor extension in delivery period (if any) etc

BANK GUARANTEE AS ADVANCE PAYMENT

Guarantee # _____
Date of Issue: _____
Date of Expiry: _____
Amount: _____

OIL AND GAS DEVELOPMENT COMPANY LIMITED

Supply Chain Management Department
OGDCL House, Jinnah Avenue,
Islamabad.

1. WHEREAS M/s _____ (hereinafter called the Supplier) have requested us to furnish a Bank Guarantee for Pak Rs. _____ (Rupees _____) being _____% advance of the ordered value of Pak Rs. _____ (Rupees _____) in respect or LPO # IBA/_____ issued on _____.

2. AND IN CONSIDERATION of your paying and advance of Pak Rs. _____, Rupees (_____) hereby guarantee to pay on demand a sum of Pak Rs. _____.

WE ALSO HEREBY AGREE:

- a) To make unconditional payment of maximum amount of Pak Rs. _____ without any question and without referring to the Supplier.
- b) To keep the guarantee in force till _____.
- c) To extend the period of enforceability of this guarantee if it becomes necessary to you and agreed to by us.
- d) We further undertake not to revoke this guarantee during its specified duration as above state except with your consent.

(BANKER)

Note: The Advance Bank Guarantee should be valid for 100% value to advance till 06 weeks* from the date of the delivery of last consignment / completion of project whichever is later.

*06 weeks are required to cover the period for authenticity of Advance Bank Guarantee, preparation of advance cheque etc.

Initiation of blacklisting Proceedings in furtherance of Rule 19 PPRA, 2004.

Case Reference:

Respondent Detail:

NAME
ADDRESS
NTN
CNIC

ENCIRCLE THE APPLICABLE

A) Undermines or adversely affect the operations of the company through any of the following:

- a) Withdrawal of bid during the bid validity period;
- b) Refusal to:
 - i. sign the contract;
 - ii. accept Purchase Order;
 - iii. execute work;
 - iv. submit Performance Security as per tender terms;
 - v. make supplies;
 - vi. fulfil contractual obligations as per contract;
 - vii. purchase order terms and conditions; and/or,
 - viii. failure to remedy underperformance as to contractual obligations.

c) Repeated non-performance.

B) Involvement in corrupt or fraudulent practices while obtaining or attempting to obtain contracts.

C). Conviction of fraud, corruption, tax evasion or criminal misappropriation by a court or competent forum.

D). Notified blacklisted/debarred/cross debarred by PPRA or any other public sector organization or international agencies.

SUPPORTING DOCUMENTS/ AFFIDAVIT

GM(LS)

GM(SCM) *JK*

A. S. S.
JK

FORMS

**INDEMNITY BOND
PERFORMANCE SECURITY
CONTRACT AGREEMENT
MOBILIZATION ADVANCE GUARANTEE/BOND**

OIL & GAS DEVELOPMENT COMPANY LTD.

INDEMNITY BOND FOR SECURED ADVANCE

AGAINST THE MATERIALS FINANCED / PAID BY THE

OIL & GAS DEVELOPMENT COMPANY LIMITED (OGDCL) (EMPLOYER)

INTERIM PAYMENT CERTIFICATE NO.

This indemnity Bond is signed, executed & issued at _____. This ____ day of

_____ by _____. having its office at _____(hereinafter called the Contractor) in favour of the OIL & GAS DEVELOPMENT COMPANY LIMITED (OGDCL) having its office-----
----- (hereinafter called the Employer).

AND WHEREAS the Contractor entered into a written Contract Agreement with the Employer dated the ____Day of _____for Construction of -----
-----.

AND WHEREAS the Contractor seeks Secured Advance payment from the Employer pursuant to Sub-Clause 60.11 of GCC Secured Advance on Materials' of the conditions of contract ; and the contractor has brought the following materials at the site for incorporation in the Permanent Works, and the materials have not yet been incorporated in the Permanent Works,

AND WHEREAS the Contractor undertakes and solemnly affirms that:

1. The materials are in compliance with the Technical specifications for the Permanent Works,
2. The materials have been delivered to the site and are properly stored and protected against loss or damage or deterioration,
3. The Contractor's records of the requirements, orders, receipts and use of materials at the site are kept in a form approved by the Employer, and such records shall be available for inspection by the Employer,
4. Ownership of the materials shall be deemed to vest in the Employer, and these materials shall not be removed from the site or otherwise disposed of without written permission of the Employer, and
5. The Contractor will not pledge any of the materials with any Bank or like agency or any individual.

NOW THEREFORE, through this Indemnity Bond the Contractor binds himself to exonerate, save harmless, indemnify and keep indemnified the Employer for and against any and all losses of whatsoever kind and nature relating to the materials including those due to theft, loot, arson, pilferage, wastage due to fire, rains, storm, earthquake, flood and inundation, shortage, damage,

deterioration and depreciation etc., of the materials, through any act of man or God, or slump in the market of the materials, financed,

Advanced or paid by the Employer on the Contractor's Request for financing / advancing/ payment.

The Contractors further declares that he will faithfully abide by the above declaration; and that in the event of his infringement of the declaration made above, the Employer will be fully entitled forfeit all such material and also proceed against the Contractor according to the relevant clause pertaining to breach of Contract and further invoke the power to seek any remedies accrued to him as the Employer under the Contract.

Further, the Contractor also authorizes the Employer to adjust the Secured Advance payment amount in full or in part from any of the Contractor's payment Certificates/bills, or adjust for

the actual incorporation of these materials in the Permanent Works, without having to make any reference to the Contractor.

Details of the materials and their cost for which Secured Advance payment is being sought by the Contractor are as under:

S. No.	Type of Material	Qty in M.Ton.	@Avg.	Amount in Rs.
01	_____	_____	_____	_____
02	_____	_____	_____	_____
	_____Advance Cost of Material at site.			_____
			TOTAL Rs.	_____

Rupees _____

Seal and Signature of the Contractor

Witnesses:

1. _____

2. _____

PERFORMANCE GUARANTEE
(Bank Guarantee Required as per OGDCL Format)

Guarantee No. _____
Executed on _____
Amount of Guarantee _____
Expiry date _____
Beneficiary: OGDCL, Islamabad

[Oil & Gas Development Company Limited, Islamabad]

Name of Guarantor (Bank) with address: _____
(Scheduled Bank in Pakistan)

Name of Contractor with address: _____

Penal Sum of Guarantee (express in words and figures) _____

Letter of Acceptance No. _____ Dated _____

KNOW ALL MEN BY THESE PRESENTS, that in pursuance of the terms of the Bidding Documents and above said Letter of Acceptance (hereinafter called the Documents) and at the request of the said Contractor we, the Guarantor above named, are held and firmly bound unto the Oil and Gas Development Company Limited (OGDCL), Islamabad (hereinafter called the Employer) in the penal sum of the amount stated above for the payment of which sum well and truly to be made Immediately and forthwith to the said Employer, we bind ourselves, our heirs, executors, administrators and successors, jointly and severally, firmly by these presents.

THE CONDITION OF THIS OBLIGATION IS SUCH, that whereas the Contractor has accepted the Employer's above said Letter of Acceptance for the execution and completion of works for **Construction of** -----
----- . (Name of Contract) and hereto attached.

NOW THEREFORE, if the Contractor shall well and truly perform and fulfill all the undertakings, covenants, terms and conditions of the said Documents and Contract/Agreement during the original terms of the said Documents and any extensions thereof that may be granted by the Employer, with or without notice to the Guarantor.

Our total liability under this Guarantee is limited to the sum stated above and it is a condition of any liability attaching to us under this Guarantee that the demand for payment in writing shall be received by us within the validity period of this Guarantee, failing which we shall be discharged of our liability, if any, under this Guarantee.

We (the Guarantor), waiving all objections and defenses under the Contract, do hereby irrevocably, unconditionally and independently guarantee to pay to the Employer immediately and forthwith upon the Employer's First and Simple written demand without cavil or arguments or question, query, objection and contestation and without requiring the Employer to prove or to show grounds or reasons for such demand any sum or sums up to the amount stated above,

OIL & GAS DEVELOPMENT COMPANY LTD.

against the Employer's written demand that the Contractor has refused or failed or annulled or suspended the contract/agreement or caused delay to perform the obligations under the Contract which payment will be effected by the Guarantor to Employer's designated Bank & Account Number.

PS-2

PROVIDED ALSO THAT the Employer shall be the sole absolute and final judge for deciding whether the Contractor has duly performed his obligations under the Contract or has defaulted in fulfilling said obligations and the Guarantor shall pay without objection question, query and contestation any sum or sums up to the amount stated above upon first written demand from the Employer immediately and forthwith and without any reference or recourse to the Contractor, Account Party Principal or any other person.

The Guarantor Bank warrants, represents and confirms that this Bank is fully authorized, empowered and has all necessary corporate approvals and authority for issuance of this Bank Guarantee.

We further guarantee that any payment made hereunder shall be made free and clear of, and without deduction for or on account of, any present or future taxes, levies, imposts, duties, charges, fees, deductions or withholdings of any nature whatsoever and by whomever imposed.

The Covenants herein contained constitute unconditional, irrevocable, independent and direct obligations of the Guarantor. No alteration in the terms of the Contract or in the extent or nature of the work to be performed thereunder and no allowance of time by the Employer or other forbearance or concession or any other act or omission by Employer which but for this provision might exonerate or discharge the Guarantor shall in any way release the Guarantor from liability hereunder.

This guarantee is governed by and shall be construed in accordance with the laws of Islamic Republic of Pakistan.

IN WITNESS WHEREOF, the above-bounden Guarantor has executed this Instrument under its seal on the date indicated above, the name and corporate seal of the Guarantor being hereto affixed and these presents duly signed by its undersigned representative, pursuant to authority of its governing body.

Witness:

Guarantor (Bank)

1. _____

Corporate Secretary (Seal)

1. **Authorized Signature** _____
2. **Name** _____
3. **Title** _____

2. _____

Corporate Guarantor (Seal)

MOBILIZATION ADVANCE GUARANTEE

Guarantee No. _____

Amount of Guarantee _____

Expiry date _____

Beneficiary: OGDCL, Islamabad

WHEREAS The Oil & Gas Development Company Limited (OGDCL) (hereinafter called the 'Employer') has entered into a Contract for **Construction of** -----
----with ----- (hereinafter called the 'Contractor')

AND WHEREAS, the Employer has agreed to advance to the Contractor, at the Contractor's request, an amount of Rupees _____(Rs _____) which amount shall be advanced to the Contractor as per provisions of the Contract.

AND WHEREAS, the Employer has asked the Contractor to furnish Guarantee to fully secure the mobilization advance for the performance of his obligations under the said Contract.

AND WHEREAS, _____
(Scheduled Bank in Pakistan acceptable to the Employer)

(Hereinafter called the "Guarantor") at the request of the Contractor and in consideration of the Employer agreeing to make the above advance to the Contractor, has agreed to furnish the said Guarantee for the amount of(say.....) as security for the fulfillment by the Contractor of their obligations under the Contract and for the reimbursement of any damages which the Employer may suffer as a result of any failure on the part of the Contractor to fulfill their obligations under the contract.

NOW, THEREFORE, the Guarantor hereby guarantees that the Contractor shall use the advance for the purpose of above mentioned Contract and if he fails and commits default in fulfilment of any of his obligations for which the advance payment is made, the Guarantor shall be liable to the Employer for payment not exceeding the aforementioned amount.

Notice in writing of any default, of which the Employer shall be the sole and final judge, on the part of the Contractor, shall be given by the Employer to the Guarantor, and on such first written demand, payment shall be made by the Guarantor of all sums then due under this Guarantee without any reference to the Contractor and without any objection. This Guarantee shall remain in force until the advance is fully adjusted against payments from the Interim Payment Certificates of the Contractor or until _____whichever is earlier.

The Guarantor Bank hereby further declares and guarantees independently, unconditionally and irrevocably for immediate payment of full amount of advance payment upon Employer's **first and simple** written demand without making any reference, recourse to Contractor, account Party or any other person and without any question, query and contestation, in case the Contractor does not fulfill their obligations or in case the contract has been annulled, non-execution of the contract or cancellation of the contract or the contract cannot be executed because of Force Majeure or if the contract turns out to be void or unenforceable. Employer, in this regard, shall be the sole, absolute and final judge.

The Guarantor's liability under this Guarantee shall not in any case exceed the sum of Rupees _____(Rs _____). This Guarantee shall expire on _____20____hours Pakistan Time. Any request for payment under the terms of this guarantee must therefore be received by the Bank prior to this time.

For Guarantor Bank Seal

Manager

1. Authorized Signature _____
2. Name _____
3. Title _____
4. in the capacity of _____
5. in the presence of _____

Witness;

1. Name: _____

Title: _____

Address: _____

2. Name: _____

Title: _____

Address: _____

FORM OF CONTRACT AGREEMENT

THIS CONTRACT AGREEMENT (hereinafter called the "Agreement") made on the _____ day of _____ 20 ____ between _____ (hereinafter called the "Employer") of the one part and _____ (hereinafter called the "Contractor") of the other part.

WHEREAS the Employer is desirous that certain Works, viz _____ should be executed by the Contractor and has accepted a Bid by the Contractor for the execution and completion of such Works and the remedying of any defects therein.

NOW this Agreement witnesseth as follows:

1. In this Agreement words and expressions shall have the same meanings as are respectively assigned to them in the Conditions of Contract hereinafter referred to.
2. The following documents after incorporating addenda, if any except those parts relating to Instructions to Bidders, shall be deemed to form and be read and construed as part of this Agreement, viz:
 - (a) The Letter of Acceptance;
 - (b) The completed Form of Bid alongwith Schedules to Bid;
 - (c) Conditions of Contract & Contract Data;
 - (d) The priced Schedule of Prices;
 - (e) The Specifications; and
 - (f) The Drawings
3. In consideration of the payments to be made by the Employer to the Contractor as hereinafter mentioned, the Contractor hereby covenants with the Employer to execute and complete the Works and remedy defects therein in conformity and in all respects within the provisions of the Contract.
4. The Employer hereby covenants to pay the Contractor, in consideration of the execution and completion of the Works as per provisions of the Contract, the Contract Price or such other sum as may become payable under the provisions of the Contract at the times and in the manner prescribed by the Contract.

IN WITNESS WHEREOF the parties hereto have caused this Contract Agreement to be executed on the day, month and year first before written in accordance with their respective laws.

Signature of the Contactor

(Seal)

Signature of the Employer

(Seal)

Signed, Sealed and Delivered in the presence of:

Witness:

(Name, Title and Address)

Witness:

(Name, Title and Address)

TECHNICAL SPECIFICATIONS

TECHNICAL
SPECIFICATIONS

(CIVIL WORK)

SECTION - 1 MATERIAL

1.0 GENERAL

Unless otherwise specified herein all materials to be used shall strictly comply with the specifications included in these documents.

1.1 BURNT BRICKS

They shall be well burnt without being verified. They shall be of uniform colour regular in shape and parallel faces. They must be homogeneous in texture and emit clear ringing sound when struck. They shall be free from flaws and cracks. They shall not absorb more than 1/5th of their weight of water being soaked for one hour and shall show no signs of efflorescence on drying.

1.1.1 Size and Strength

The nominal size of the bricks shall be 9"x4-3/8"x2- 11/16" (228x111x68mm) and the minimum size shall not be less than 8-5/8"x4-1/8"x2-5/8" (219x105x67mm). The compressive strength shall not be less than 1400 lbs/sq. inch.

1.2 FINE AGGREGATE

1.2.1 Source

Fine Aggregate shall be obtained from approved sources.

1.2.2 Grading

Fine Aggregate shall consist of well-graded sand stone screening or other inert material of similar characteristics or a combination of these.

Fine Aggregate shall conform to the requirements of B.S. 882 and/or PS 243. Only Fine Aggregate of grading zones 1 to 3 (B.S. 882) shall be used. Aggregate of zone A may be used for special mixes only after written approval.

1.2.3 Cleanliness

Fine Aggregate shall be clean and free from clay lumps soft and flaky particles, shale, alkali, organic matter, loam, mica and injurious amounts of deleterious substances shall not exceed 5 percent by weight.

1.2.4 Quality Fine Aggregate shall be sharp, cubical , hard ,dense and durable.

1.2.5 Storage and Protection

Fine Aggregate shall be stacked on a brick, wooden or other suitable platform so as to adequately protect it from dust and other admixtures. These may be washed if required.

1.3 Course Aggregates

1.3.1 Source

Unless otherwise specified in the contract, Course aggregates shall be obtained from an approved source. Coarse aggregate should conform to the requirements of B.S. 882 and/or P.S. 243 or as approved by the Consultants In-charge.

The gradation limits shall conform to the requirements of the B.S. 882 Part-I, 1905 or any latest amendments. It shall consist of quarried crushed stone or other inert material and

combination of these as specified or as approved by the Consultants Incharge.

Course aggregates shall be well graded, within the range of 3/16" (4.8 mm) of any size or range of sizes within such limits as actual specified for any particular work or wherever feasible the normal maximum size of aggregate for cast-in-place reinforced concrete slabs and other thin members shall be 3/4". If there are difficulties in placing such a concrete the maximum size may be restricted to 1/2" provided the requirements for strength are satisfied, as approved/directed by the Consultants Incharge.

1.3.2 Cleanliness

Coarse aggregate shall be clean and free from soft, friable, thin or elongated pieces, alkaline organic matter or injurious amounts of deleterious substances.

The sum of the percentage of all deleterious substances in any size shall not exceed 3 percent by weight.

Cleanliness of the aggregate should conform to the requirements of ASTM C-117, C-142, C-123 and C-140.

1.3.3 Quality

Coarse Aggregate shall consist of well shaped hard dense durable uncoated rock fragments as approved by the Consultants Incharge.

1.3.4 Storage and Protection

Coarse aggregate shall be stacked on a brick wooden or other suitable platform so as to adequately protect it from dust and other admixtures. Each type and size of aggregate shall be stacked separately. These should be washed if required and Contractor will do this without any extra charges.

1.4 BITUMENOUS MATERIAL

1.4.1 General

The bituminous material shall be straight grade asphalt of 10/20 penetrations for use in damp proofing work in DPC and filling in expansion joints etc.

The material shall be of best quality manufactured in Pakistan and shall conform to the following specifications: -

a]	Specific Gravity at 77 °F	1.02/1.04
b]	Softening Point (R & B)	170/200°F
c]	Penetration at 70°F, 100 gm.	10/20
d]	Ductility at 77°F (cm)	4/7
e]	Solubility in Ce 14 (Min.)	14 (min) 99.5%
f]	Working Temperature	300/350°F

1.4.2 Protection/Test

The approved quality of materials shall be brought in sealed containers or with a certificate of manufacturer regarding the quality/standard of the material. The storage and application of the material shall strictly follow the manufacturer's instructions written on the container or elsewhere.

1.4.3 Bituminous Material for Water/Damp Proofing, Expansion Joints etc.

Straight grade of Nexphalt of 10/20 penetration SIB or SIB shall be used for filling in expansion joints and water proofing of roof.

Special industrial bitumen of 10/20 penetration grade shall be used as sealing material in roof insulation work or DPC, it shall be a mineral filled thixotropic special bitumen emulsion which meets A.I.B. standard No. 4683.03 and shall have the following properties: -

emulsion.	a]	Base Material	Bitumen/latex/	coautchouc
	b]	Solvents	Free from Solvents.	
	c]	Consistency	Soft Paste.	
	d]	Density	1.1 gm/cm ³	
	e]	Dry Residue	05%	
	f]	Flash Point	Non Flamable	
Heat)	g]	Heat	Resistance Up to 150°C (Dry	

1.4.4 Mastic Asphalt

Mastic asphalt shall be used as sealing material for the foundation raft, it shall conform to B.S. Specifications 1097- Oct. 1973 for (Mastic Asphalt for tanking and damp proof course).

1.4.5 Special Imported Water Proofing Material (VANDEX)

Special Imported Water Proofing material shall be used to completely water proof basement. It shall be applied in accordance with the manufacturer's recommendations and the applicable drawings.

1.5 BITUMENIZED PAPER/POLYTHENE

1.5.1 General

Unless otherwise specified the building paper shall conform to B.S. 4016. It shall be smooth stout and possess through water proofing qualities. Building Paper/Polythene sheet shall be used where specified in the Drawings. Double layer shall always be used with 2" (50 mm) side laps and 6" (150 mm) end laps wherever specified.

1.5.2 Test Sample

The building paper if used shall weigh 40 to 50 Kg./100 meter square (8 to 10 lbs./100

Sft.). In case of polythene sheet the thickness shall not be less than 0.2mm (.008") per layer.

The samples shall be approved before incorporation in the work. The Contractor shall submit the samples, which shall be retained till the completion of the work. The cost of such samples shall be deemed to be included in unit rate of the relevant items entered in the Bill of Quantities.

1.6 CLAY / EARTH

1.6.1 General

Clay shall be plastic and obtained from approved sources and shall have fine sand in the range of 20 to 30%. It shall not contain more than 0.5% soluble salts; more than 0.2% Sulphate, more than 4% organic contents. It shall not contain any gravel, coarse sand, kanker, roots of grass and plant and other injurious matters.

1.6.2 Preparation

Clay before use shall be dug up and left to weather for a week. It shall be thoroughly watered repeatedly turned over and tempered for at least 48 hours before use until it is homogeneous and stiff.

1.7 WIRE GAUZE

1.7.1 General

Unless otherwise specified the wire gauze shall be of best quality approved uniformly, woven wire webbing of 12 x 12 meshes to 645 square mm (one Sq. Inch) made from 24 gauge galvanized iron wire. All panels shall be in one piece and no joints shall be allowed in the gauze.

1.7.2 Fixing

Wire gauze shall be fixed as shown on the drawings or as directed. The gauze shall remain tight to the full width without any sag.

1.8 GLASS

1.8.1 General

Clear Glass shall be of best quality (imported) except as may be otherwise called for on the drawings or as provided in the relevant item of BOQ or called for drawings.

Quality

The quality and specifications of glass used shall be as follows:-

All glass shall be of approved manufacture and quality.

Its manufacturer shall label each kind of glass described below and shall be labeled by its manufacturer and the labels left on until their removal is authorized by the Consultants Incharge.:

- a] Sheet glass unless specified otherwise shall be flat drawn weighing not less than 6.87gms/sq.cm. (22-1/2 ounces per square foot) and shall be the type as defined in the British Standard Specification 952 or equivalent ASTM Standard.
- b] Obscure glass unless specified shall be best quality bajri glass manufactured in Pakistan (Khawja/Prince) or as approved by the Consultants Incharge. It shall not

be less than 5mm thick or as given in the relative item of BOQ and at least as obscure as syenite glass.

- c] Plate glass unless specified otherwise shall be of the quality as defined in British Standard 952 and shall not be less than 5mm thickness or as given in the relative item of BOQ. Glazing compound for use in wooden frames for interior and exterior glazing shall conform to the requirements of B.S. 544. Compound for metal frames shall be as recommended by the manufacturer for the particular application and approved by the Consultants Incharge..

1.8.2 Samples

Samples of all kind of materials to be used in the job shall be submitted for approval by the Consultants Incharge/consultant before incorporation in the work.

1.9 LIME

1.9.1 Definition

Unless otherwise specified "LIME" shall mean stone lime or Kanker Lime.

1.9.2 Source of Stone Lime

Stone fat or white lime shall be manufactured from limestone containing at least 90% pure carbonate of lime.

1.9.3 Source of Kanker Lime

Kanker lime shall be burnt from good quality kanker nodules having a blue grey fracture, free from sand grains. The kanker shall be quarried from an approved source.

1.9.4 Storage

Lime shall be stored in dry and weather proof sheds in a compact heap so as to expose as small an area as possible to air to prevent air slaking. Lime shall not be stored for a long period after burning but used as fresh as possible.

1.9.5 General

Wherever lime appears in specifications or Bill of Quantities it will be taken to mean " Lime Putty " .

1.10 PAINTER AND DECORATOR

1.10.1 Conformity to Standards

Except as otherwise specified, all painting work shall be carried out in conformity with British Standard Code of Practice CP-231 "Painting" as applicable to the work.

1.10.2 Materials

All materials used shall conform to the applicable British Standard Specifications and shall be used as per manufacturer's printed directions.

Paints shall be high grade enameled products of known manufacturer and, when approved, shall be delivered on the work in original unbroken packages bearing the manufacturer's brand and name.

Colour Pigments shall be pure, non-fading and finely grounded and at least 99% passing through a 325 mesh sieve.

Distemper/Vinyl Emulsion obtained shall be of an approved quality and make. It shall be delivered at site in original unbroken packages bearing the maker's name and brands. Any pigment content shall be lime proof.

Snowcem/Durocem shall be delivered at site in original and sealed packages, bearing the manufacturer's brand and name.

Brushes All brushes used for Painting work shall conform to the requirements of B.S. 2092.

Lime shall conform to B.S. 890 "Building Lime".

Wax Polish shall be of best quality available in Pakistan and as approved by the
Consultants
Incharge/consultant.

Spirit Polish shall have shellac of approved quality.

1.10.3 Colour Schedule

The colour, shade and surface finish required for various materials shall be as approved.

1.10.4 Samples and Application Specifications

Samples of the paints used for the work shall be approved as and same type of paint shall be used throughout.

Certified data, test samples and detailed application specifications shall be submitted for approval. If the material is to be tested, the Contractor at his own cost will be done this from an approved laboratory.

1.11 VARNISH

1.11.1 Source

Varnish shall be procured from an approved source or manufacturer.

1.11.2 Quality

Varnish shall be clear, transparent and suitable for use on exterior or interior work, as specified and shall give a uniform and glossy coating, free from runs and specks. Varnish shall become surface dry not more than 6 hours for interior and 8 hours for exterior work and hard dry not more than 18 hours.

The loss in weight on heating in a suitable oven after placing on a metal dish at a temperature of 105 degree to 110 degrees centigrade for 3 hours shall not exceed 50%.

1.11.3 Composition

Unless otherwise specified it shall be best English Copal.

1.11.4 Colour

The colour and shade shall be as approved.

1.11.5 Supply and Storage

The ready made varnish shall be packed in sealed tins and shall bear the batch number of production and the date of manufacture. The varnish shall be used after one year of its manufacture.

1.12 DISTEMPER

1.12.1 Source

Distemper shall be obtained from an approved source or manufacturer as approved.

1.12.2 Quality

When thoroughly mixed and applied it shall give a uniform colour free from runs and specks.

1.12.3 Storage

Distemper shall be stored in sealed tins and only in such quantities as shall be consumed within one year of its manufacture.

1.13 TIMBER

1.13.1 Source

Timber shall be procured from an approved source and shall be in accordance with the requirements of B.S. 1186 - Part I.

1.13.2 Quality

Unless otherwise specified, timber shall mean Deodar wood for all carpentry, joinery and structural works, as specified in the drawings.

Timber shall be of good quality felled not less than two years before use for carpentry and four years for joinery work and shall be properly seasoned. Timber shall be uniform in texture, straight in fibres, free from open shakes, bore holes, fungus attack, rots, dots, decay, warps, twists, springs or cracks and all other defects and blemishes.

1.13.3 Sap Wood

Sapwood shall not be permissible in any work i.e. in carpentry, joinery and structural works.

1.13.4 Knots

Timber shall be free from knots, other than sound knots appearing on surface only and not exceeding 1/2" (15mm) diameter. Such loose or decayed dead knots shall not be permissible in any joinery and shall be cut out and plugged properly.

1.13.5 Shakes

Straight splits or shakes shall be permissible in the ends up to a total for both ends of 2" (50mm) per meter of length at the time of passing.

Timber shall not be spongy or in brittle condition.

1.13.6 Size

The round logs of timber shall not be less than 10' (3 meter) and more than 40' (12 metre) in length and 7' (2.1 metre) in girth. Tapered logs shall not be less than 4' (1.2 metre) in girth at the small end.

Squares shall be of the size not less than 10' (3 metre) in length and 16"x16" (400mm x 400mm) in cross section.

Sleepers shall be obtained from logs cut from sound and mature trees.

1.13.7 Storage

Timber shall be stacked on a raised wooden or paved platform to eliminate chances of white ant attack.

It shall be stacked under a proper shelter, where maximum aeration is possible without subjecting it to the direct sun, rain or other weathering agents.

1.13.8 Miscellaneous

In all other respects, timber should conform to the applicable requirements of B.S. 1186.

1.14 WATER

1.14.1 Source

Water for construction shall be obtained from an approved source.

1.14.2 Quality

Water shall be free from clay, vegetable, organic impurities and any other substance likely to cause efflorescence or interfere with setting of mortars or otherwise be harmful to the work. Broadly speaking any water which does not show an intensive odour or brackish taste shall be considered suitable for building works, whereas water fit for drinking, shall be accepted as suitable for all Consultantsing works. P.H. value of water shall range between 6 and 8. Where doubts exists as to the suitability of water it shall be tested in accordance with B.S. 3148.

1.14.3 Storage

Water shall be stored in water tight tanks or containers adequately protected from the admixture of dust and other foreign matter.

1.15 PORTLAND CEMENT

These specifications cover five types of port-land cement, as follows: -

- | | |
|------------|---|
| Type - I | For use in general concrete construction when the special properties specified for type-II, III, IV and V are not required. |
| Type - II | For use in general concrete construction exposed to moderate sulphate action, or when moderate heat of hydration is required. |
| Type - III | For use when high early strength is required. |
| Type - IV | For use when low heat of hydration is required. |
| Type - V | For use when high sulphate resistance is required. |

1.15.1 Definition

Portland cement is the product obtained by pulverizing clinker consisting essentially of hydraulic calcium silicates to which no additions have been made subsequent to calcinations, other than water and/or untreated calcium sulphate, except that addition of other non-deleterious materials may be added at the option of the manufacturer in an amount not to exceed 0.1%.

1.15.2 Physical Requirements

Portland cement of each of the five types shown above shall conform to the requirements of ASTM Designation C-150 or B.S. Specifications No: 12.

1.15.3 Packing and Marking

When the cement is delivered in packages, the name and brand of the manufacturer and the type, shall be plainly identified thereon. When the cement is delivered in bulk this information shall be contained in the shipping invoice accompanying the shipment. A bag shall contain 50 Kg. All cement shall be fresh and of approved origin and manufacture.

1.15.4 Inspection

Every facility shall be provided for careful sampling and inspection either at the mill or at the site of work. The following periods from time of sampling shall be allowed for completion of testing.

1-day test	6 days
3-day test	8 days
7-day test	2 days
28-day test	33 days

1.15.5 Rejection

The cement may be rejected if it fails to meet any of the requirements of these specifications. Cement remaining in bulk storage at the mill, prior to shipment for a period greater than six months after completion of the tests, may be tested and may be rejected if it fails to conform to any of the requirements of these specifications.

If the variation in weight of any shipment is 3% on the lower side than the entire shipment may be rejected.

Cement failing to meet the test for soundness in the autoclave may be accepted if it passes a retest, using a new sample, at any time within 28 days thereafter. The provisional acceptance of cement at the mill shall not override the right to reject on a retest of soundness at the time of delivery of the cement.

The Contractor shall supply, if required, at fortnightly intervals, test Certificates with the dates of such tests, showing that the cement complies with the appropriate standard. These tests shall be carried out in a approved laboratory.

Only one brand of each type of cement shall be used for concrete in any individual member of the structure. Cement shall be used in the sequence of receipt of shipment, unless otherwise directed.

There shall be sufficient cement on site to ensure that each section of work is completed without interruption.

Cement reclaimed from cleaning of bags or from leaky containers shall not be used.

The mixing together of different types of cement will not be permitted.

1.15.6 Method of Sampling and Testing

The sampling and testing of port-land cement shall be in accordance with relevant B.S. or A.S.T.M. (C-150-74) standard specifications.

Contractor shall carry out tests on Ordinary Portland Cement, Sulphate Resistant Cement and White cement at his own cost, if and when required.

1.15.7 STORAGE

- i] The sacks should be stacked closely on a damp proof floor or on timber planks raised 12" (300mm) or so from the ground with air space below. There should be similar air space between the stacks and walls and roof of the building, which should have sound weather proof walls and roof.
- ii] To avoid bursting of bags and setting under pressure the height of the stacks shall be limited to 8 bags.

1.15.8 Limitation of Use

No cement stored through a monsoon or for more than six months should be used, unless tests have been applied and cement meets the requisite standard.

1.15.9 Sulphate Resisting Cement

The sulphate resisting cement is to conform to the B.S. Specification Nos: - 4027, 1966 that stipulate as below:

i] Chemical Analysis:

Magnesium Oxide	4.0 %	(Max.)
Loss of Ignition	4.0 %	(Max.)
Insoluble Residue	1.5 %	(Max.)
Tri Calcium Aluminates	3.5 %	(Max.)
Lime Saturation Factor	0.66-1.02%	(Max.)

ii] Physical Tests :

Fineness Specific Surface Sq. Cm. per Gm.	2500	(Max.)
Soundness, Le-Chatelier Test	10mm	(Max.)

a] Vicat Test, initial Set in Minutes	45	(Max.)
b] Final Set in Hours	10 Hrs	(Max.)

iii) Compressive Strength

3 Days - Lbs. Per Square Inch	2200
7 Days - Lbs. Per Square Inch	3400

(iv) Action of Sulphate on Portland Cement

The Sulphate Resisting Cement where specified shall conform to P.S. 612 or B.S. 4027 with appropriate content of Tricalcium aluminate. A requirement of ASTM C-150 for Type (V) is that the contents of C-4 AF plus twice the amount of C3A shall not exceed 20 percent.

1.15.10 Guidelines for the Use of Sulphate Resisting Cement

To save the structures from sulphate attack and to obtain lasting immunity, the following precautions should be taken when using sulphate-resisting cement.

- i] Water curing of the structures should be done for a longer period before exposure to the sulphate water. An intermediate period of drying in air also increases the resistance owing to the formation of an impermeable calcium carbonate skin.
- ii] A rich mix should be used with a low water cement ratio.
- iii] A dense concrete should be used to give it a greater tightness against penetration by the sulphate solutions.
- iv] Steam curing at a temperature of 100 degree Centigrade and above greatly increases the resistance to sulphate attack, sometimes to the point of immunity. Curing below 100 degrees Centigrade does not increase the resistance and sometimes decreases it.

1.16 WHITE CEMENT

1.16.1 White Cement

White Cement shall be non-staining, water repellent Portland Cement conforming to relevant B.S. or ASTM standard which shall be tested in accordance with the relevant stipulations of C 1.15.6 for Ordinary Portland Cement.

White Cement used where specified shall conform to the Specifications of iron oxide contents below 1 percent. The strength characteristics shall be the same as ordinary Portland Cement but produced in an oil fired cement kiln at 3100 °F (1704 °C) burning temperature. To compensate for reduced strength in cementing power, the cement contents of mix shall be increased by 10 to 15 percent.

1.16.2 Characteristics / Properties

White Portland Cement is a chemical product of several compounds, which are in a state of fine division chemically active and highly sensitive to moisture. Its essential qualities are hydraulic in nature i.e. it sets and hardens when worked with water. A good white cement which combines the properties of its numerous compounds, will set when water is added to it in a regulated time; it will harden and gain strength progressively, its strength will not show retrogression in strength at a later period and will have constancy of volume. Above all, the basic requirement it has to fulfill concerns its appearance which must be white, without any contamination of iron or anything else. To maintain this primary property viz. whiteness, great care has to be taken at every stage of its production.

The characteristic and properties of white cement are fineness, setting time and soundness. It has to conform to the most rigorous specification in respect of soundness. This is most important, for any lack of proportion in the elements that produce it or any negligence in the production processes would spoil the product. In other words even the slightest defect in the manufacture would make the things made from it such as hydraulic tiles or other moulded articles unsatisfactory.

1.17 COLOURED CEMENT

1.17.1 Coloured Cement

Colours are imparted to ordinary cement by mixing colouring matter to it in the form of mineral pigments. Usually 5 to 10 percent of the colouring matter is added to obtain the required shade. The mineral oxide used, as pigments are rather costly.

Iron oxide gives red, yellow or brown; Chromium oxide gives green colour; Cobalt gives blue colour. For black or brown colour manganese dioxide is used. White cement is prepared with raw materials almost free from iron; it has the normal setting of ordinary cement, except for the absence of any colour but white.

1.18 MILD STEEL REINFORCEMENT GRADE 40 & 60

1.18.1 Material and Manufacture

The bars shall be rolled from billets properly identified heats of mold cast or strand cast steel using the open hearth, basic Oxygen, or electric- furnace process. The reinforcement steel shall be obtained only from the approved manufacturers.

1.18.2 Chemical Requirements

Manufacturers shall perform analysis of test samples and determine the percentages of carbon, manganese phosphorus and sulphur. The phosphorus content shall not exceed 0.05%. It will be obligatory for the Contractor to furnish manufacturers certificate stating chemical composition of the Steel Reinforcement.

1.18.3 Requirements for Deformations

Deformation shall be spaced along the bar at substantially uniform distance. The deformations on opposite sides of the bar shall be similar in size and shape. The spacing height and gap of deformations shall conform to the requirements prescribed in Table-1.

1.18.4 TABLE - 1 DEFORMED BAR DESIGNATION NUMBER, NORMAL WEIGHTS, NOMINAL DIMENSIONS AND DEFORMATION REQUIREMENTS.

NOMINAL DIMENSIONS In Inches *REQUIREMENTS *DEFORMATION In Inches

BAR NO.	WT. LB/FT	DIA IN.	X-SEC AREA IN 2	PERI-METER IN	MAX. AVERAGE SPACING	MIN.AVER AGE HT.	MAX. CAP
3	.376	.375	.11	1.178	.262	.015	.143
4	.668	.500	.20	1.571	.350	.020	.191
5	1.043	.625	.31	1.963	.437	.028	.239
6	1.502	.750	.44	2.356	.525	.038	.286
7	2.044	.875	.60	2.749	.612	.044	.334
8	2.670	1.000	.79	3.142	.700	.050	.383
9	3.400	1.128	1.00	3.544	.790	.056	.431
10	4.303	1.270	1.27	3.990	.889	.064	.487
11	5.313	1.410	1.56	4.430	.987	0.71	.540
14	7.650	1.693	2.25	5.320	1.185	.085	.648
18	13.600	2.257	4.00	7.090	1.580	.102	.864

1.18.5 Mechanical Properties of Reinforcing Bars

The material shall conform to the requirements for tensile and percentage of elongation properties as presented in Table-2

TABLE 2: TENSILE REQUIREMENTS CONFORMING TO ASTM 615

	GRADE 40	GRADE 60
Tensile Strength Minimum (in psi)	70,000	90,000
Yield Strength Minimum PSD	40,000	60,000
Elongation in 8: Piece. (in %age)	% age	% age
Bar No.		

3	11	9
4	12	9
5	12	9
6	12	9
7	11	8
8	10	8
9	9	7
10	8	7
11	7	7

1.18.6 Bending Requirements

The bend-test specimen shall stand being bent around a pin without cracking on the outside of the bent portion. The requirements for degree of bending and sizes of pins are prescribed in Table-3.

Bar Designation No.	Plain Diameter for "Bend Tests d-nominal diameter of Specimen	
	Grade-40	Grade-60
3,4,5	4d	4d
6	5d	5d
7, 8	5d	6d
9, 10, 11	5d	8d

"Test bends 180° unless noted otherwise.

1.18.7 Permissible Variation in Weight

The permissible variation shall not exceed 6 percent under nominal mass. Reinforcing bars shall be evaluated on the basis of nominal masses. In no case shall the over weight of any bar be the cause for rejection.

1.18.8 Finish

The bars shall be free of injurious defects and shall have a workmanlike finish.

Rust, seams, surface irregularities, or mill scale shall not be cause for rejection, provided the weight, dimensions, cross-sectional area, and tensile properties of a hand wire brushed test specimen are not less than the requirements of this specification.

1.18.9 Plain Mild Steel Bars

Unless otherwise specified, all plain reinforcing bars shall comply with the requirements of B.S. 785 for plain mild steel bars and shall have a minimum yield strength (characteristic strength) of 36,000-lbs/inch sq.ft.

1.19 THERMOPORE

The material shall be of approved manufacture and of best quality available in Pakistan. The thermo pore shall be of the type used for insulating roof be approved by the Consultants In-charge.

The insulation shall conform to the following physical requirements:

Density (Average) Lbs. per Cft.	6 to 8.5
Specific Gravity (Average)	0.12
Flexural Strength (Average Kg per Sq.Cm.)	3.6 to 4.3
Impact Strength (Cm/Kgm per Sq.Cm.)	0.3 to 0.7
Compressive strength (Cm/Kg per Sq.Cm.)	0.17 to 1.44

Deflection (average)	0.25	to
Inches		
Thermal conductivity (Average)		
maximum BTU at mean temperature		
10 Degree F.	0.22	

1.19A BRICK TILES

Description

Clay tiles shall be either hand moulded or machine moulded.

Manufacturing

Tiles shall be manufactured from well prepared clay and properly burnt and shall conform to specification

No.3.1 Schedule of Rates Volume-1 Pact-1 of 1964 of West Pakistan Standing. Rates Committee.

Quality

The tiles shall be free from fire crack true in shape dense tough shall show a clean fracture when broken and shall be well burnt throughout.

Colour

The colour of tiles shall be uniform throughout.

Size

The nominal size of tiles shall be 0.225 m x 0.112m x 0.037m (9" x 4-1/2" x 1-1/2").

Transverse Strength Test

The average breaking load applied along the width of the tile midway between the supports shall not be less than 78.75 kg (175 lbs.).

Water Absorption Test

The average water absorption test shall not exceed one sixth of its dry weight.

1.20 SOLID FLUSH SHUTTERS (COMMERCIAL PLY) BOTH SIDES

Solid flush doors of approved manufacturers and of best quality available in Pakistan or as approved shall be used.

The plywood shall be in accordance with the requirements of B. S. 1455: 963.

Glue

For joints work enamel glue complying with B. S. 745, Casein glue complying with B. S. 745 and cold setting Casein glue complying with B. S. 1204 shall be used.

1.20A HOLLOW FLUSH SHUTTERS (Commercial Ply on Both Sides)

Hollow flush doors shall be hydraulically pressed; of reputed manufacturers and of best quality available in Pakistan or approved by the Consultants In-charge. shall be used where called for.

The plywood shall be in accordance with the requirements of B.S. 1455:1963.

1.21 TERMITE PROOFING MATERIAL

Dieldrin / Alderin 20% emulsified concentrated or 0.5% solution of Heptachlor or de-Termite Emulsion or another approved shall be used as per manufacturers Specifications.

1.22 HARD BOARD

1.22.1 General

The hard board shall be of approved manufacturer. It shall be hard and stout and shall not warp in moist climate nor turn into laminations. Shall be free from cracks, flaws, dents, etc. shall be sufficiently thick to support the weight it has to take where being used. It shall have uniform colour and thickness and shall have an average density of 30 to 50 lbs per cft.

1.23 CHIP BOARD

1.23.1 General

The Chip Board in general shall be medium density of best quality available in the country and shall have uniform texture and thickness conforming to B.S. 2604 : 2604. The surface shall be of such nature so as to give good adhesion to the decorative lamination to be pressed on to it. They should be free from flaws, cracks, or any sort of weak spots. The density shall be in the range of 50-53 lbs/sft and the modulus of rupture shall be between 1,500 to 3,000 lbs/sq.in.

1.23.2 Samples

The contractor for approval before placing order to the supplier shall submit the samples and these samples will be retained till the completion of work. The cost of such samples shall be deemed to be included in the unit rates of the relevant items entered in the Bill of Quantities.

PLUMBING AND SANITARY FIXTURES

1.24 WATER CLOSET

1.24.1 Source

Unless otherwise specified the water closet shall be of best quality manufactured in Pakistan or as approved by the Consultants In-charge.

1.24.2 Composition

The water closet shall be made of ceramic ware plastic in one piece of material.

1.24.3 Quality

Each water closet shall show good workmanship without dents or faults. The surface and colour shall be uniform, non-corrodible, and free from discoloration and imperfections.

1.24.4 Colour

The colour of the water closet shall be white or as approved.

1.24.5 Type

Type of the water closet shall be Asian / European as specified in the drawings or as approved.

1.24.6 Size

The size of the water closet shall be as specified in the drawings or as approved.

1.24.7 Trap

The trap shall be either S or P type as approved. For manufacture and quality it shall conform to the above specification for water closet. Each trap shall have a circular opening of 102mm (4") dia. for connection of anti-siphonage pipe.

1.24.8 Foot Rest

For squatting/Asiatic pattern type water closet the footrest shall be an integral part of the water closet.

1.25 SEAT

1.25.1 Source

Unless otherwise specified the seat shall be in double seat cover comprising a seat and a cover hinged together of best quality manufactured in Pakistan or as approved by the Consultants In-charge.

1.25.2 Composition

Seat shall be as per manufacturer's Standard.

1.25.3 Quality

Seat shall be made in one piece. It shall be thoroughly cured and free from blisters. The surface shall be highly polished impervious and hygienic.

- 1.25.4 Type
- Seat shall be of closed or open pattern as per manufacturer's Standard or as approved by the Consultants In-charge.
- 1.25.5 Shape
- The shape of the seat shall be in conformity with the type of water closet specified. The underside of the seat shall be flat and shall not be recessed. For closed pattern seat the hinging devices shall be either of good quality non-ferrous metal or any other corrosion resistant material.
- 1.25.6 Bolts
- The bolts shall be of non-ferrous material 65 mm (2- 1/2") in length. Two bolts shall be provided with each seat.
- 1.25.7 Buffers
- Seat shall be provided with rubber buffers of 250mmx37mm (1"x1.5") size and 9.5mm (3/8") thickness. The buffers shall be rigidly attached to the seat. The metals in contact with buffers shall be non-ferrous. The cover of the seat for closet pattern shall have buffers not less than two in number
- 1.25.8 Colour
- The colour of the seat shall be black or as approved by the Consultants In-charge.
- 1.26 FLUSHING CISTERN
- 1.26.1 Source
- Cistern shall be obtained from approved source, which shall be of the best quality manufactured in Pakistan or as approved by the Consultants In-charge..
- 1.26.2 Composition
- Low-level non-completed coupled cistern shall be made of plastic or ceramic ware in one piece of materials. For manufacture and quality it shall conform to Specifications of water closet.
- 1.26.3 Capacity
- The capacity of the cistern shall be 13.5 liters (3 Gallons).
- 1.26.4 Quality
- Each cistern shall show good workmanship without dents or faults. The surface and colour shall be uniform free from discoloration and imperfections.
- 1.26.5 Brackets/Bolt Kit
- Brackets shall be of material as approved by the Consultants In-charge. The length of the bracket shall be such as to enable 100mm (4") embedding in the wall or fixed to the wall with the help of screws. Where bolt kit is available as standard Accessory it shall conform to manufacturers specifications.
- 1.26.6 Cover
- For composition and quality the cistern cover shall conform to the corresponding specifications of cistern.

1.26.7 Flush Pipe

Flush pipe shall be of 31mm (1-1/2") internal diameter PVC painted with white enamel paint. It shall be manufactured either from steel or non-ferrous materials as approved.

If steel pipe is to be used as approved by the Consultants In-charge, it shall be either galvanized or chromium plated both internally and externally as approved. Moulded rubber cone shall be provided for connection with the water closet.

1.26.8 Ball Valve and Component Parts

Ball valve and its component parts shall be either of brass or gunmetal or any corrosion resistant alloy or plastic. These shall be sound, hard, smooth and well finished. The mechanism of component parts shall be such that when the position is in contact with the face of seat the short arm of the level shall be in vertical position. Ball valve shall not leak when rested to a pressure of 210.9 x 10³ Kg/sq. meter (300 P.S.I.). It shall not displace water more than half its volume when left in water.

1.27 WASH HAND BASIN

1.27.1 Source and Type

Wash Hand Basins shall be of an approved best quality and type manufactured in Pakistan as approved by the Consultants In-charge.

1.27.2 Composition

Wash Hand Basin shall be made as ceramic ware in one piece of material as approved by the Consultants In-charge.

1.27.3 Manufacture

Each Wash Hand Basin shall be fired at such a temperature as to produce satisfactory fused clay.

1.27.4 Quality

Each Wash Hand Basin shall show good workmanship without dents or faults. The surface and colour shall be uniform non-corrodible, non-ferrous, free from discoloration and imperfections. The basin shall be so designed to control slopping.

1.27.5 Colour

Colour of the wash hand basin shall be white or as approved by the Consultants In-charge.

1.27.6 Size

The size of the wash hand basin shall be as specified in the Bill of Quantities and as approved by the Consultants In-charge.

1.27.7 Overflow

Overflow shall be either of open ware type with removable grating or of a bolt type as specified. The slot for overflow shall be 63mm long 12.7 mm deep (2.5" long and 1/2" deep). It shall be so designed as to facilitate cleaning.

1.27.8 Soap tray or Sinking

Soap tray or sinking shall be so provided as to drain into the basin.

- 1.27.9 Tap Holes
- The tap holes shall be squarer to fit pillar taps and shall be beveled around the opening. They shall be so situated as to allow supply pipes to be clear of waste and vent pipes and shall have enough space to prevent the user striking the head on the tap.
- 1.27.10 Waste Hole and Grating
- Waste hole shall have a minimum diameter of 63mm (2.5") The outlet shall be beveled or rebated. The tap hole shall be square in shape and each side shall be of 29mm (1.1/8") length. Chromium plated grating of appropriate diameter shall allow free drainage of water and be securely fitted to basin without any leakage.
- 1.27.11 Plug Chain and Stay Hole
- Plug shall be of rubber. The diameter of the plug shall be such as to fit snugly in the waste hole. The chain shall be of brass/chromium plated one end fixed to the plug and the other end in the chain stay hole. The position of the stay hole shall not be lower than the over flow slot.
- 1.27.12 Brackets
- Brackets shall be of an approved material. The length of the bracket shall be such as to enable 100mm (4") embedding in the wall or fixed to the wall with the help of screws.
- 1.27.13 Stud Slots
- Stud slots shall be monolithically cast with the wash hand basin. These shall receive the brackets on the inside of the basin and shall be so situated that the brackets remain 50mm (2") away from the face. These shall not exceed 12.7 mm (1/2") in dia 7.9 mm (5/10" in height and shall be 300mm (12") from the back of the basin to the center of the side. The side studs shall be 63mm x 125mm x 16mm (2-1/8" x 5" x 5/8") and centre of stud shall be 300mm (12") from the back of the basin.
- 1.28 WASTE PIPE
- Waste Pipe shall be of 38mm (1-1/2") internal diameter. It shall be PVC painted with enamel paint, or chromium plated OR of DADEX or as specified in the BOQ.
- 1.28.1 Bottle Type Trap
- All the wash hand basins shall be provided with a bottle type trap (Chromium plated or stainless steel as approved) and connected with the basin and waste pipe.
- 1.29 TOOTH BRUSH HOLDER WITH TOOTH PASTE DISH
- 1.29.1 Source and Type
- Tooth brush holder with tooth paste dish shall be of best quality and type manufactured in Pakistan as approved.
- 1.29.2 Composition
- It shall be made of Stainless Steel.
- 1.29.3 Quality
- Each toothbrush holder shall be of best quality and show good workmanship. The surface and colour should be uniform, non-corrodible, and free from discoloration and imperfections.
- 1.29.4 Size
- Size of the toothbrush holder shall be as approved by the Consultants.

1.30 SINK

1.30.1 Source and Type

Sink shall be of best quality and type manufactured in Pakistan and as approved by the Consultants.

1.30.2 Composition

It shall be made of 18-gauge stainless steel or as approved by the Consultants.

1.30.3 Quality

Each sink shall show good workmanship without dents or faults. The surface and colour should be uniform non-ferrous free from discoloration and imperfections.

1.30.4 Size

Size of the stainless steel sink shall be as specified in the Bill of Quantities or as approved by the Consultants.

1.31 PILLAR COCK

1.31.1 General

Pillar Cock shall be chromium plated and of best quality manufactured in Pakistan. These shall be of screw down type with jam nut. Internal diameter of the tap shall be 13 mm (1/2").

1.32 ONE HOLE MIXER

1.32.1 General

- a] One-hole mixer for washbasin.
- b] One hole mixer high cock for sink.

One hole mixer shall be chromium plated and of best quality manufactured in Pakistan. These shall be of screw down type with jam nut. Internal diameter of the tap shall be 13mm (1/2").

1.33 URINALS

Urinal shall be of best quality manufactured in Pakistan and as approved by the Consultants.

1.33.1 Composition

Urinal shall be made as a ceramic ware in one piece of material as specified and as approved by the Consultants.

1.33.2 Manufacture

Each urinal shall be fired at such a temperature as to produce satisfactory Fused Clay.

1.33.3 Quality

Each urinal shall show good workmanship without dents or faults. The surface and colour shall be uniform free from discoloration and imperfections.

- 1.33.4 Colour
- Colour of the urinal shall be white or as approved by the Consultants.
- 1.33.5 Flushing Cistern
- 4.5 litres capacity automatic C.I. cistern best quality local made enamel painted or Ceramic type best quality local made as specified in the Bill of Quantities.
- 1.33.6 Type
- The type of the urinal shall be as approved by the Consultants.
- 1.33.7 Waste Pipe
- Waste pipe shall be of 38 mm (1-1/2") internal diameter. It shall be manufactured either from steel or non-ferrous materials as approved. The steel pipe shall be either galvanized (internally and externally) or chromium plated as approved by the Consultants.
- 1.33.8 Brackets
- Brackets shall be painted iron. The bracket shall be either of such a length as to enable 100 mm (4") embedding in the wall or shall be such as to be fixed to the wall with the help of screws.
- 1.34 TAPS AND STOP COCKS (TEE ANGLE ETC.) _____
- 1.34.1 Source
- Taps and cocks shall be of best quality manufactured in Pakistan and as approved.
- 1.34.2 Composition
- The bodies and heads shall be of hard brass or gun metal or hot pressings of brass of manganese bronze. Spindles, glands, crutches, washer plates and nuts shall be of brass or manganese.
- 1.34.3 Quality
- Castings shall be from metal poured into the moulds while hot pressing shall be metal pressed between dies.
- Pressing shall be smoother and shall present a better appearance. These shall be plated with zinc or chromium as specified.
- 1.34.4 Requirements
- Tap and cocks shall be fitted with a cover of pressed sheet metal threaded for attachment to the head and which can be cleaned easily. The stem of washer, plate (called a jumper) shall be either loose or fixed by screwing to the spindle with the help of a grub screw.
- 1.34.5 Size
- Size of the taps and cocks shall be as specified or as approved.
- 1.35 C.P. SHOWER AND C.P. ARMS _____
- 1.35.1 Source and Type
- The C.P. Shower with arms shall be of an approved best quality and type manufactured in Pakistan.

1.35.2 Composition

It shall be made of best quality materials duly chromium plated in accordance with the latest specifications as approved.

1.35.3 Quality

It shall be of best quality and show good workmanship. The surface and colour should be uniform non- corrodible free from discoloration and imperfections.

1.35.4 Size

The C.P. shower shall be from an approved manufacturer and of the sizes specified.

1.36 C.P. SOAP DISH

1.36.1 Source and Type

C.P. Soap dish shall be of an approved best quality and type manufactured in Pakistan.

1.36.2 Composition

It shall be made of best quality materials duly chromium plated in accordance with the latest specifications as approved.

1.36.3 Quality

It shall be of best quality and show good workmanship. The surface and colour should be uniform non- corrodible, free from discoloration and imperfections.

1.36.4 Size

The size of the C.P. Soap dish shall be as approved or as specified.

1.37 C.P. TOILET PAPER HOLDER

1.37.1 Source and Type

The C.P. Toilet Paper holder shall be of an approved best quality and type manufactured in Pakistan.

1.37.2 Composition

It shall be made of best quality materials duly chromium plated in accordance with the latest specifications as approved.

1.37.3 Quality

It shall be of best quality and show good workmanship. The surface and colour should be uniform non- corrodible, free from discoloration and imperfections.

1.37.4 Size

The size of the toilet paper holder shall be as approved or as specified.

- 1.38 C.P. TOWEL RAIL
- 1.38.1 Source and Type
C.P. Towel Rail shall be of an approved best quality and type manufactured in Pakistan.
- 1.38.2 Composition
It shall be make of best quality iron pipe duly chromium plated in accordance with the latest specifications as approved.
- 1.38.3 Quality
It shall be of best quality and show good workmanship smooth surface and colour should be uniform non- corrodible, free from discoloration and imperfections.
- 1.38.4 Size
It shall be of 3/4" dia x 24" long (19mm x 600mm) long.
- 1.39 MIRROR
- 1.39.1 Source and Type
Mirror shall be of best quality Belgium or local as specified make with Chromium plated screws.
- 1.39.2 Composition
It shall be made of best quality materials in accordance with the latest British Standard Specifications as approved.
- 1.39.3 Quality
It shall be of best quality and show good workmanship and surface should be uniform and free from imperfections and distortion.
- 1.39.4 Size
Size of the mirror shall be 24" x 18" x 1/4" or as specified.
- 1.40 PLATE GLASS SHELVES WITH C.P. GUARD RAILS
- 1.40.1 Source and Type
Plate glass shelves with C.P. guard rails shall be of an approved best quality and type manufactured in Pakistan.
- 1.40.2 Composition
It shall be made of best quality materials in accordance with the latest specifications as approved.
- 1.40.3 Quality
It shall be of best quality and show good workmanship. The surface and colour should be uniform non- corrodible, free from discoloration and imperfections.
- 1.40.4 Size
It shall be of size 24"x5"x3/16" (600x125x5mm) or as specified.

- 1.40.5 C.P. Hanger
The C.P. hanger shall be of an approved best quality and type manufactured in Pakistan.
- 1.40.6 Composition
It shall be made of best quality materials duly chromium plated in accordance with the latest specifications.
- 1.40.7 Quality
It shall be of best quality and show good workmanship. The surface and colour should be uniform non- corrodible, free from discoloration and imperfections.
- 1.40.8 Size
The size of the C.P. hanger shall be as approved.
- 1.41 TIMBER GRILL
- 1.41.1 Source and Type
Timber grill shall be of first class deodar wood as approved.
- 1.41.2 Composition
It shall be manufactured from 1st class deodar wood duly painted with 3 coats of enamel paint as approved.
- 1.41.3 Quality
It shall be of best quality and show good workmanship.
- 1.41.4 Size
It shall be of 27"x27"x3" (675mmx675mmx75mm) size or as approved.
- 1.42 FLOOR TRAPS
- 1.42.1 Source and Type
The floor trap shall be of an approved best quality and type manufactured in Pakistan.
- 1.42.2 Composition
It shall be made of best quality cast iron in accordance with the latest specifications with C.P. Grating of specified size.
- 1.42.3 Quality
It shall be made of best quality and show good workman- ship. The surface shall be uniform, non-corrodible, non-ferrous and free from imperfections.
- 1.42.4 Size
The size of the flow trap shall be as specified or as approved.

1.43 GULLY TRAPS

1.43.1 Source and Type

Gully traps shall be of an approved best quality and type manufactured in Pakistan.

1.43.2 Composition

It shall be made of best quality earthenware duly glazed with 150x150mm cast iron gratings. A brick masonry chamber plastered with 1:3 cement sand mortar both inside and outside shall be constructed over the gully trap with C.I. frame and cover of required size.

1.43.3 Quality

It shall be of best quality and show good workmanship. The surface shall be uniform free from imperfections.

1.43.4 Size

It shall be (9"x9") 225mmx225mm) or as specified or approved.

1.44 VALVES

Air relief valves, non-return valves, gate valves etc.

1.44.1 Source and Type

The valves shall be heavy duty and of an approved best quality and type manufactured in Pakistan.

1.44.2 Composition

- a) Air relief valve shall have small orifice valve, rubber balls, brass air vent orifices, gun metal nipple, screw down valve and seats, operating screws. The valve shall be capable to resist 153 meter of water pressure.
- b) Non-return valves body shall be of cast iron or bronze with gunmetal seats and stainless steel hinges. The valve shall be capable to resist a pressure of 150 metre of water.
- c) Gate valves, heavy-duty type brass, gunmetal or bronze of best quality, manufactured in Pakistan as approved and capable to resist a pressure of 150 metre of water.

1.44.3 Size

As per Bill of Quantities.

1.45 MANHOLE COVER AND FRAME

1.45.1 Source and Type

Manhole cover and frame shall be of an approved best quality and type manufactured in Pakistan conforming to B.S.S 497.

1.45.2 Quality

It shall be of best quality and show good workmanship. The surface shall be uniform, non-corrodible, non-ferrous and free from imperfections.

1.45.3 Size

18" (450mm) dia weight 1/2 Cwt or as specified in the B.O.Q.

1.46 CAST IRON SOIL PIPES (SPUN TYPE)

1.46.1 Cast iron soil pipes and fittings shall be of an approved best quality manufactured in Pakistan which shall be truly cylindrical with clear internal diameter as specified having a uniform thickness smooth and with strong and deep sockets free from flaws air bubbles, cracks, sand- holes and other defects. They shall not be brittle but shall allow for ready cutting chipping or drilling.

1.46.2 Standards

When used underground the thickness and weight of cast iron pipes shall not be less than those shown in the following table:

Internal Diameter	Weight per 6 ft. length (including socket & headed spigot or flanges, the socket not less than 3/8" thick)
2" (50 mm)	24.9Kg.
3" (75 mm)	34Kg.
4" (100 mm)	48Kg.
6" (150 mm)	70.3Kg.

1.46.3 Treatment

Before use all cast iron pipes and fittings shall be treated with two coats of Angus Smiths composition or the Dower-Barft process or Marceline's glass enamel or other approved means of preventing oxidation.

1.46.4 Type

Cast iron soil pipes shall be either spigot Ted or socketted or flanged at both ends as specified.

1.46.5 Length

Cast iron soil pipes shall be in 6 ft. (2 meter) long pieces including socket and beaded spigot or flanges at both ends.

1.46.6 Plain Bend, Door Bend and Plug Junction

For quality and treatment the specials shall conform to the corresponding specification of cast iron soil pipe. The size shall be as specified.

1.47 REINFORCED CEMENT CONCRETE PIPES

1.47.1 Source

Reinforced cement concrete pipes of specified quality shall be of approved manufacturer.

1.47.2 Composition

Pipe shall be made of reinforced cement concrete. The cement concrete shall be Class - B for all Classes of pipes (1:1-1/2:3).

1.47.3 Quality

Pipe shall be of uniform internal diameter and thickness throughout its length. The

minimum amount of reinforcement for different diameters of pipes shall be as given in Tables No. I and II.

1.47.4 Collars and Sockets

Collars and sockets shall conform to the above specifications for composition quality and reinforcement.

1.47.5 Standard

The standard thickness, weight and reinforcement for different diameters of pipes and collars shall be as given in Table No. 1 & 2.

1.47.6 Tolerance

The internal diameter of pipe shall not deviate from the nominal internal diameter by more than 1/8" (3mm) upto 18" (450mm) diameter; 1/4" (6mm) upto 48" (1200mm) diameter. The radial thickness of the wall of pipe or its fittings shall not vary more than specified below:

Pipe diameters in inches	Variation in radial thickness in inches
3 to 18	+1/16
20 to 36	± 3/32
38 to 48	± 1/8

The internal diameter of the socket or collar shall have a minimum clearance when fixed to the pipes as specified below :

Nominal Internal diameter of pipe in inches	Minimum clearance between spigot and socket or collar in inches
3 to 18	3/8
10 to 18	5/8
24 to 48	¾

1.47.7 Hydraulic Test

Pipe barrel shall withstand the specified internal pressure without showing any sign of injury or sweating. The pressure shall be applied at a rate not exceeding 10 PSI in 5 second and full pressure shall be maintained for at least thirty seconds.

TABLE NO.1

Diameter	Steel Reinforcement for Pipes				Steel Reinforcement for Collars			
	Spirals		Straight Rod		Spirals		Straight Rod	
	Gauge	Weight per Pipe	Size	Weight per Pipe	Gauge	Weight per Collar	Size	Weight per Collar
1	2	3	4	5	6	7	8	9

E-CLASS

Inches		lbs.		Lbs.		Lbs.		Lbs.
3	14	0.56	3/16"	2.80	12	0.07	3/16"	.36
4	12	0.76	3/16"	2.94	12	0.10	3/16"	.43
5	12	1.32	3/16"	3.03	12	1.16	3/16"	.52
6	12	1.47	3/16"	3.25	12	0.24	3/16"	.60
7	12	2.31	3/16"	5.25	12	0.27	3/16"	.67
8	12	2.75	3/16"	5.35	12	0.34	3/16"	.75
9	12	3.14	3/16"	6.4	12	0.39	3/16"	.80
10	11	3.56	3/16"	7.0	11	0.42	46	.90
12	11	5.22	4G	10.2	11	0.85	4G	1.1
15	11	8.16	4G	15.2	10	1.2	¼"	1.3
18	9	15.01	¼"	16.1	9	2.28	¼"	1.6

TABLE NO.1

1.47.9 M-CLASS PIPES AND COLLARS

Inches		lbs.		Lbs.		Lbs.		Lbs.
3	14	1.81	3/16"	4.67	12	0.31	3/16"	.5
4	12	1.90	3/16"	5.0	10	0.33	¼"	.53
5	12	2.13	3/16"	5.25	10	0.35	3/16"	.57
6	12	3.09	3/16"	5.25	10	0.39	3/16"	.65
7	12	4.97	3/16"	5.83	10	0.56	3/16"	.08
8	12	6.0	¼"	6.0	9	0.85	¼"	.85
9	12	6.02	¼"	7.6	9	0.75	3/16"	.9
10	11	7.8	4.G	8.5	8	1.05	4G	1.0
12	11	12.40	4G	10.2	7	1.74	4G	1.1
15	11	18.5	3G	12.1	6	2.13	¼"	1.7
18	9	33.62	3G	18.7	6	2.24	¼"	2.3

H-CLASS

Inches		lbs.		Lbs.		Lbs.		Lbs.
3	14	2.17	3/16"	4.67	10	0.35	3/16"	.5
4	12	3.28	3/16"	5.0	9	0.51	3/16"	.53
5	10	4.35	3/16"	5.25	9	0.63	3/16"	.57
6	10	5.87	3/16"	5.25	8	0.74	3/16"	.65
7	9	7.61	3/16"	5.83	8	0.88	4G	.8
8	9	11.27	¼"	6.0	7	1.31	4"	.8
9	8	11.85	¼"	7.0	7	1.46	¼"	.9
10	8	15.87	4G	8.5	6	1.05	¼"	1.0
12	7	24.16	4G	10.2	5	6.2	¼"	1.1
15	6	36.8	3G	12.1	5	4.43	¼"	1.7
18	4	66.31	3G	18.7	3	8.33	¼"	2.3

TABLE NO.2

1.47.10 R.C.C. PIPES

S. No.	Bore dia Inches	A- None Pressure		B- Tested to 75- Head		C- Tested to 150 - Head		D- 200 - Tested to Head	
		Thick-Weight Ness Incheslbs.		Thick-Weight ness Incheslbs		Thick-Weight ness Incheslbs		Thick- ness Inches	Weight lbs
1.	3	1	14	1	14	1	14	1	-
2.	4	1	18	1	18	1	18	1	-
3.	5	1	21	1	21	1	21	-	-
4.	6	1	26	1	25	1	25	1	-
5.	8	1	32	1	32	1-1/2	50	1	95
6.	9	1	36	1	36	1-1/2	-	1-1/2	-
7.	10	1-1/8	42	1-1/8	42	1-1/2	60	-	62
8	12	1-3/16	54	1-3/16	54	1-1/2	70	-	-
9.	15	1-1/4	71	1-1/4	71	1-7/8	114	-	92
10.	18	1-3/8	95	1-3/8	95	2	114	-	-

- 1.47.8 R.C.C. PIPES AND COLLARS (6 FEET LENGTH)
- 1.48 GALVANIZED IRON PIPES
- 1.48.1 Source
- Galvanized iron pipes shall be of specified quality and of an approved manufacture.
- 1.48.2 Composition
- Pipes shall be of best quality galvanized iron.
- 1.48.3 Quality
- Pipes shall be sound castly workable with drill or file and free from imperfections. Its inner and outer surface shall be smooth. Each pipe shall be properly galvanized. It shall have screw threads on both ends for jointing with sockets.
- 1.48.4 Welding Socket
- High frequency induction welding, Socket shall conform to the above specifications of galvanized iron pipes for composition and quality.
- 1.48.5 Requirements
- All straight lengths of pipes and its threads shall be protected with socket and jute covering.
- 1.48.6 Test
- Pipes shall be capable of withstanding a pressure 700 psi. The pipes shall comply with Specification No. B.S. 1387, C-M.
- 1.48.7 Galvanized Iron Specials
- The specials shall normally be of G.I. manufactured to the same specifications as the pipes but where these are not available locally manufactured gun metal specials can be used. It shall be ensured that the threads are not worn out. The fittings shall be tested by jointing at least 5 percent of the local supplies to straight pipes with sufficient pressure. Defective fittings invariably crack on application of pressure. The fittings shall also be examined to detect blisters and minor cracks. The fittings shall also be hydraulically tested to a pressure of 200 ft. of water head.
- 1.49 FIRE HYDRANT
- 1.49.1 Source
- The fire hydrant shall be of an approved quality and manufacture.
- 1.49.2 Composition
- Head valve gate and nozzle cap shall be made of cast iron. Outlet nozzle, valve seat drain valve stuffing box glands gland box nut and operating stem shall be of bronze or any other corrosion resistant alloy as approved.
- 1.49.3 Quality
- The component parts of the hydrant shall be free from flaws air bubbles cracks and holes

and other defects. The main valve shall be faced with rubber or leather and in case of slide gate tubes shall have bitumastic barrel rings. All exposed surfaces shall be painted with three coats of an approved quality paint. The capacity of hydrant shall be given at hydrant top and nozzle cap. It shall be self lubricating type.

1.49.4 Requirements

The requirements of fire hydrant shall be:

- i) Pitch of the stem thread shall be such that water hammer shall not exceed working pressure.
- ii) In case the upper portion of the barrel is broken off, hydrants shall remain reasonably tight.
- iii) It shall be capable of taking a flow of not less than 150 gallons per minute.
- iv) To prevent freezing a non-corrodible drip valve shall be provided to drain the barrel when the main valve is closed. Main valve shall be faced with a yielding material such as rubber for the compression type or a bronze ring for the gate type and a seat of bronze or other non-corrodible material.

v) Outlet threads shall conform to those used in the system.

1.49.5 Type

Type of hydrant shall be either "SUNK" or "FLUSH" as approved.

1.49.6 Size

Size of the hydrant shall be 2-1/2" dia or as specified.

1.50 EXTERNAL FITTINGS / SPECIALS

1.50.1 Source

The external fittings shall be of an approved source and quality.

1.50.2 Composition

The external fittings shall be made of cast iron.

1.50.3 Quality

Each fitting shall be of the clean diameter as specified of uniform thickness with smooth and strong spigot and socket or flanges as specified. It shall be free from flaws and air bubbles, cracks and holes and other defect.

1.50.4 Standard

Each fitting shall conform to the respective standards.

1.50.5 Size

Size of each fitting shall be as specified or approved.

1.51 Jumbolon

Jumbolon with excellent results in its Heat insulation is used in construction.

Jumbolon must have the following physical properties.

Item	Unit	Result	Testing Method
Color		White/Black/Grey	
Cell Structure		Closed, very fine	

DensityKg/M3	32-70	ISO 845 1988 (E)
UV-Resistance	Excellent	ASTM 547 BS4433
Odor	Nil	
Temperature Range C	-80 to 85	
Flexibility	Good	BS 4433

Construction Requirements:

Jumbolon is placed on bitumen treated surface.

Jmbolon is laid in two layers. First layer is 4 mm thick and second layer 25mm thick.

Samples:

Samples of the material will be submitted to the Consultant before the job is executed.

.....End of Section.....

2.1 DESCRIPTION

The work to be done under this section consists of Clearance of site from any material, dismantling and demolition of existing structure (if any) including clearing out site of all rubbish, grass, shrubs, brush wood, under growth, roots and trees and disposal of the material obtained thereof outside the site area to any disposal point as instructed by the Engineer incharge.

Securing permanent bench marks at given levels and grades wherever required.

General grading and leveling of the site to achieve a proper drainage.

Removing all construction or demolition debris after completion of the work to a distance of at least 100 meters from the outermost lines of the site or as required by the local authorities.

All bench marks pegs, flags, pillars or any similar item and labour required for the setting out of the work shall be arranged by the Contractor. The cost of such item is to be included in the rate quoted by the Contractor in other items of work to be carried out under the Contract.

No tree shall be cut without the written orders. The wood obtained shall be neatly stacked and handed over to the Employer or his representative.

The ground shall be leveled and graded in accordance with the plans, sections or in the absence of such drawings as may be directed.

2.2 CONSTRUCTION REQUIREMENTS

2.2.1 Demolition Work

During demolition, the Contractor shall see that no damage or injury is done to the parts of the work which are to be retained, and that the demolition is executed with appropriate tools and in such a manner as to render unserviceable as little of the materials as possible.

Boards, battens, frames and wood work, sheets, tiles, slates, trusses, R.S. beams and all such materials likely to be damaged if dropped from a height, shall be carried to the ground or lowered with ropes.

2.2.2 Dust Prevention

To minimize nuisance from dust, arrangements shall be made for the erection and removal of screens or canvas or other suitable material and for watering the work as the demolition proceeds.

2.2.3 Sorting and Removal

All dismantled materials shall be property of the Employer and shall be sorted and stacked where ordered. Doors and windows shall be removed from the chowkhats with their hinges before dismantling the later. The work of removing dismantled material up to 300 feet, sorting and stacking the same will be done within the rate.

2.2.4 Disposal

As required, the Contractor shall remove the whole or a portion of dismantled material from the site of work. The method of disposal of such material shall be subject to approval.

2.3 MEASUREMENT/PAYMENTS

The measurement and payments for clearance of site, disposal and layout of Buildings shall not be made to the contractor separately, the contractor will include all the expenses of site clearance in his quoted rates.

.....End of Section.....

3.1 DESCRIPTION

The work under this Section consists of excavating, in all types of soil, lifting, transportation and disposal of the excavated material, back-fill and fill for building foundations, and under floors including all incidental work necessary for excavation to the required depth and dimensions and in accordance with the Drawings or as directed. The work shall be carried out in complete conformity with the specifications set-forth hereunder.

All fill or refill around structures, i.e. within the slopes and limits of the established lines for excavation for the structures and below the natural surface level, shall be defined as "Back Filling".

All fill or refill (from the excavated earth at site) about structures, i.e. above the natural surface level shall be defined as "filling under floors or embankment from excavated" soil".

All fill or refill, from the material provided and brought from outside the site (any lead), about structures, i.e. above the natural surface level shall be defined as "filling under floors with earth provided and brought from outside".

Filling shall be approved selected material from excavated or other predominantly granular material, free from slurry and organic or other unsuitable matter and capable of compaction by ordinary means.

Filling around pipes and cables shall be carefully placed; fine material shall cover the pipe of cable completely before the normal filling is placed.

Material for back filling shall conform to the requirements of Specifications. It shall be placed in layers of 6" and saturated with sufficient water or otherwise compacted to produce not less than 95 percent in situ density with respect to the maximum density at optimum moisture content, achieved in Test No. 12 of B.S. 1377-1967.

Filling shall not be placed against foundation walls without first obtaining approval to do so. Filling shall be brought up evenly on each side of the walls as far as practicable. Heavy equipment for spreading and compacting the fill shall not be operated closer to the wall than a distance equal to the height of the fill above the top of footing.

3.1.1 Setting Out

Lines and levels shall be set out by the Contractor who shall be responsible for maintaining all stakes and witness points set up for the work in strict accordance with the requirement and drawings.

3.1.2 Cleaning

All areas requiring clearing shall be cleared of all trees, bushes, rubbish and other objectionable matter and such materials shall be removed from the site of work or otherwise disposed off as approved. Any damage to the works of public or private property caused by Contractor's operation shall be made good through repair or replacement at the sole expenses of the Contractor.

3.2 AUTHORIZED OUTLINES

Unless otherwise specified or directed in writing, all earthwork, i.e. excavation of trenches, pits, etc. for foundations, filling under floors, etc. shall be executed to the widths, depths, lengths, alignments grades and levels shown on the drawings. If they are not indicated on the drawings then the Contractor shall prepare the drawing showing the existing ground levels and the actual grades and levels of excavation for obtaining necessary approval.

Similarly for all backfill and fill works the Contractor shall prepare drawings showing the existing ground levels and the actual finished level to ascertain the volume of fill for obtaining approval before the commencement of work.

3.3 CONSTRUCTION REQUIREMENTS

3.3.1 Excavation in Foundations & Backfilling

i) Lines and Grades

The bottom and side slopes of excavation upon or against which structures or other required constructions are to be placed shall be finished accurately to the required grades and dimensions and, if required by the Consultants, shall be moistened with water and tamped or rolled with suitable tools or equipment for the purpose of forming firm foundation. Whenever the natural foundation material is disturbed or loosened or excavated beyond the approved lines and grades the loose material shall be removed and the extra excavation made good at Contractor's expense with selected materials, which shall be thoroughly compacted by tamping rolling in layers not exceeding 6" (150 mm). If at any point in the excavation material unsuitable for foundation is encountered as determined by the Consultants, he shall be directed in writing its removal and excavation shall be filled with lean cement concrete class-E (1:4:8). The cost of this replacement with lean concrete shall be determined and paid in accordance with the conditions of contract.

ii) Location for Placing Excavated/Surplus Materials

The excavated/surplus earth shall not be heaped within 5 ft. (1.5 m) of the top edge of any foundation. The surplus material shall be disposed off within the site without any additional cost to the owner as specified and directed by the Consultants.

iii) Inspection of Foundations

Foundation trenches shall be inspected and approved by the Consultants before foundation is laid. If safe foundation could not be obtained at the depth shown on the drawings or at maximum depth of five feet below the ground level, the Consultants may order such additional work, as he may consider necessary pursuant to the condition of the contract. Price if any shall he pay in accordance with the provision of the Conditions of the contract.

iv) Excavation to be kept Free of Water

All excavations shall be kept free from water from whatever source it may come at all times except where otherwise specified or permitted in writing.

v) Excess Excavation

In the event of any excavation being carried out wider or deeper than shown on the drawings, the Contractor at his own expense to meet the required dimension and levels with concrete or any other material approved for such purpose shall fill it in.

vi) Planking and Strutting

The Contractor shall provide at his own expense all timbering, piling, shoring, strutting and other approved supports to the sides of all excavation, trenches and all other works in such a way as will be sufficient to secure them from falling and to prevent any movement. The Contractor shall submit his proposals with drawings/sketches for approval prior to execution of any such construction work. All pecuniary and other responsibilities connected with this part of the work shall rest with the Contractor.

In removing timbering, shoring and strutting and all other supports from excavation and trenches etc., special care shall be taken to avoid bringing pressure to bear on any concrete or other work until it has hardened sufficiently to resist such pressure.

vii) Classification of Material

No classification will be made for payment purposes of any material excavated as to its class, nature, origin or condition, unless an unusual obstruction or embedded matter or substance is encountered. If this occurs, it shall be submitted by the Contractor for evaluation of design and working out of a necessary treatment. New items shall be mutually agreed.

viii) Transportation of Materials

All carts, trucks or other vehicles used by the Contractor for transportation of the material shall be suitably constructed or lined out to permit any leakage of soil while the vehicles are on the move. These would be so loaded and arranged as not to spill on the site and public roads. Whenever any vehicle so used is found leaking and unsuitable it shall be immediately withdrawn from the work.

ix) Termite Control

The approved foundation trenches shall be treated with the termite control solution as provided under section "Termite Control".

x) Compacted Fill and Backfill

It comprises returning, transportation and filling the selected excavated material around foundations, and at back of walls etc., up to finished levels shown on the drawings or as required in layers not exceeding 6 inches carefully rammed and consolidated (with addition of water if required) so as to achieve a minimum relative density of 90%. No filling shall be made until the concrete foundations and footings etc., have been inspected and approved. Earth to be used for filling must be free of all the organic impurities, debris or any other foreign matter. Earth which contains more than 1% of salts, particularly sulphates, will not be used in filling.

In case of non-sufficiency of excavated material and unsuitability of earth for back-filling, appropriate material conforming to the Specifications the Contractor shall bring requirements. Necessary Laboratory tests shall be carried out at the Contractor's expense.

3.4 EARTH FILLING UNDER FLOORS

Excavation of Works

After the masonry has been laid upto the plinth level and the Damp Concrete Proof Course, if required is laid the space between the walls shall be cleared of debris and loose earth shall be laid in layers of 6" (150 mm) and each layer watered and compacted until the filling is completed upto the base level of the floor as shown on the drawings. Only sandy soil free from saltpeter either from the materials excavated from the foundations if such materials is suitable and sufficient or suitable material brought from outside shall be used.

3.5 SAND FILLING UNDER FLOOR

Unless otherwise specified the base of all ground floors shall be constructed in accordance with the following specifications:-

- a) Sand filling shall be done in layers not more than 4" (100 mm) thick and shall be rammed after saturation to such an extent that 4" (100 mm) layer is reduced to about 2.7" (68 mm) after compaction.

The required in situ density w.r.t. maximum density to optimum moisture content shall be in compliance with test 12 of B.S. 1377-1967.

- b] The base shall be perfectly level. A slope of 1:64 shall be provided in verandahs and bath rooms if required.
- c] Sand shall conform in all respect to the specifications for fine aggregate except for its grading, i.e. it shall pass through a sieve No. 16 and not more than 30% shall pass through a sieve No. 100.

3.6 MEASUREMENTS

The measurement shall be made of the number of units of one cubic feet of between the neat lines of walls or as specified otherwise and above original ground level acceptably filled with earth as specified for the actual Net quantity as per the approved drawings in cu.ft/m. by taking measurements of trenches, pits, etc.

b] For Backfilling

The Measurement in Cu.ft/m shall be made for the actual quantity back filling as per approved drawing of the rammed/compacted earth.

c] For filling Earth/Sand under Floors

Measurement shall be made for actual quantity as per approved drawings in Cu.ft/m by measurement of the rammed/compacted earth.

3.7 PAYMENTS

The payments shall be made of the number of units of the cubic feet each measured as provided above at the contract, unit rate for this item in the BOQs and shall constitute full compensation for filling watering ramming earth floors with surplus earth from foundation or with earth brought from outside all in accordance with the applicable Technical provisions and drawings.

.....End of Section.....

4.1 DESCRIPTION:

The work consists of providing termite control treatment in foundations plinth and under floors with the solution of Dieldrin/Aldrin 20% Emulsifiable concentrate (E.C.) or 0.5% solution of Heptachlor or another as approved by the Consultants.

4.2 MATERIAL REQUIREMENTS:

Dieldrin/Aldrin 20% Emulsifiable concentrate or 0.5% solution of Heptachlor shall be of approved manufacturers and shall be brought at site in manufacturers sealed tins.

4.3 CONSTRUCTION REQUIREMENTS:**4.3.1 Extent of Application:**

Unless otherwise specified all sides of structural members below floor level and bottoms of excavated trenches/pits, floors beds and underside of plinth protection are to be sprayed with the solution.

4.3.2 Preparation of Solution:

CHLOROFOS (48 TC) in the ratio of 1:70 spraying as per manufacturer specifications by approved specialist with a warranty of Ten year, to foundations trenches (base +sides) and under floors with a pressure spray equipment maintaining a pressure of 150psi.

4.3.3 Method of Application:

The solution shall be applied with approved pressure spraying equipment maintaining an adequate pressure to all applications to, on or in the earth. Solution shall also be sprayed in trenches around the building under plinth protection. Pesticide shall penetrate to a depth of 25 mm (1") minimum in porous earth at sides and 50 mm (2") to 75 mm (3") at bottoms of excavation and floor beds. After back-filling to plinth level, the area is again to be sprayed with pesticide solution. Wherever wooden/ply surfaces are to be treated by spraying, it shall be carried out with approved hand compression sprayer at the specified pressure as per instructions of the Consultants.

4.3.4 Rate of Application:

The pesticide solution shall be applied at the rate 1 gallon/4.5 liters of 0.5% solution to 10 sq.ft./one sq.m. of the area to be treated or as per manufacturers specifications.

4.3.5 Precaution:

The contractor shall take extreme care to avoid any mishap due to the injurious effects of the chemicals and shall keep the "Owner" indemnified from any losses, damages or expenses in this connection whatsoever.

Note: - The general contractor shall engage a specialist contractor approved by the Consultants for the purpose of Termite proofing.

4.4 MEASUREMENTS AND PAYMENT

The measurement shall be made in sq.m/sq.ft. by measuring and multiplying length into breath/height/depth of the actually treated surface by spraying the solution.

.....End of Section.....

5.1 DESCRIPTION

This item covers the manufacture, forming, transporting, placing, and stripping of forms, finishing and curing of plain and reinforced normal concrete in the structures included herein.

5.2 SPECIFICATIONS

Concrete work shall conform to all requirements of ACI 301-72, (Revised 1975), Specifications for Structural Concrete for Buildings, except as modified by supplemental requirements below. The Contractor shall submit, for approval before commencement of any work, his Method Statement which would provide complete details of the procedures and equipment to be used for the satisfactory execution of the work.

5.3 COMPOSITION AND QUALITY

Concrete shall be composed of port-land cement, water, fine and coarse aggregates and any admixtures as and when specified. The concrete mixtures will be designed by the Contractor who will determine the required quality of the concrete for the structures covered by these Specifications. The desired strength of concrete for various parts of the structure have been shown on the Drawings.

5.4 CEMENT5.4.1 General:

Cement shall be furnished in sacks or in bulk form as approved. Unless otherwise permitted, cement from not more than two plants shall be used and in general, the product of only one plant shall be used in any particular section of the work. No cement recovered through cleaning sacks shall be used.

5.4.2 Portland Cement

Portland Cement shall be indigenous stuff unless otherwise approved. Portland cement shall conform to British Standard 12:1971, Specifications for Portland Cement or to ASTM Designation C150-74, Standard Specifications for Portland Cement Type - I conforming to ASTM Designation C150-74, Type - II or IV may also be used in certain parts of work as specified and directed by the Consultants.

5.4.3 Tests:

Cement shall be sampled at storage site and tested from time to time in accordance with the ASTM Designation C150-74 or its equivalent British Standards. Expenses for such tests shall be borne by the Contractor. If the tests prove that the cement has become unsatisfactory, it shall be removed from the site immediately. Cement, which has been in storage longer than four months, shall not be used until re-testing proves it to be satisfactory.

5.4.4 Transportation of Cement:

Transportation of the cement from the mill to the site stores and to the point of use shall be accomplished in such a manner that the cement is completely protected from exposure to moisture. Cement, which has been adversely affected by moisture, shall be rejected. Cement in sacks shall be delivered in strong, well made, paper or cloth bags, each plainly marked with the manufacturer's name, brand, type of cement and the weight of cement contained therein. Packages varying more than 3 percent from the weight marked thereon may be rejected and if the average weight of packages in any consignment as shown by weighing

fifty packages taken at random, is less than that marked on the packages, the entire consignment may be rejected. Packages received in broken or damaged condition shall be rejected or may be accepted only as fractional packages as determined by the Consultants.

5.4.5 Storage:

Cement shall be stored in dry, weather tight and properly ventilated structures. All storage facilities shall be subject to approval and shall be such as to permit easy access for inspection and identification of each consignment. Adequate storage capacity shall be furnished to provide sufficient cement to meet the peak needs of the project. Cement in sacks shall be stored on a damp proof floor and shall not be piled to a height exceeding 6 feet.

The Contractor shall use cement in the approximate chronological order in which it is received at the site. All empty sacks shall be promptly disposed off.

Cement storage facilities shall be emptied and cleaned by the Contractor when so directed, however, the interval between required cleaning normally will not be less than four months.

Suitable, accurate scales shall be provided at site for weighing the cement in stores and elsewhere on the work, if required, and he shall also furnish all necessary test weights.

5.4.6 Delivery and Usage Record:

The Contractor shall keep accurate records of deliveries of cement and its use in the works. Copies of these records shall be supplied in such a form as may be required.

5.5. AGGREGATE

5.5.1 Requirements:

Aggregates for normal concrete shall conform to the ASTM Designation 'Concrete Aggregates'. Following tests shall be carried out at the Contractor's cost to determine suitability of the material for the intended use.

- a] Mechanical properties
- b] Porosity
- c] Organic impurities
- d] Clay and Silt Contents
- e] Abrasion and Soundness Tests
- f] Alkali Re-activity Potential
- g] Water soluble Chloride Contents.

The nominal maximum size of the aggregate shall not be larger than one fifth of the narrowest dimension of the finished wall or slab, or larger than three fourth of the minimum clear spacing between the reinforcing steel and embedment. These limitations may be waived if, in the judgment of the Consultants, workability and method of consolidation be such that the concrete can be placed without honey-comb or voids.

5.5.2 Composition:

The use of natural sand or a combination of natural and manufactured sands may be permitted, provided that the fine aggregate meets the applicable requirements of the Specifications herein, for particular use intended. Coarse aggregate shall consist of gravel, crushed stone or a combination thereof.

5.5.3 Source:

The Contractor shall obtain concrete aggregate from deposits of natural sand and gravel or shall procure crushed aggregate from approved quarries, which produce aggregates meeting the Specifications.

5.5.4 **Sampling and Testing:**

During construction, aggregates will be sampled and tested as delivered to the mixer to determine compliance with Specification. The Contractor shall provide facilities as may be necessary for the ready collection of representative test samples. Testing of concrete aggregates shall not relieve the Contractor of his responsibility to maintain control, to ensure the production, stockpiling and handling of both fine and coarse aggregates in accordance with these Specifications.

5.5.5 **Processed Aggregate:**

Aggregates, as delivered to the mixer, shall consist of clean, hard and uncoated particles. Lightweight elements (chalk, clay, coal) will be separated by segregation under water by vibration (vibro-floatation process). Where required, fines shall be removed from the coarse aggregate by adequate washing. The coarse aggregate shall be re-screened just prior to delivery to the concrete mixer bins. The moisture content shall conform to the provisions of C 5.5.13 - Moisture Control. Compliance with the aggregate grading and uniformity requirements will be determined at the mixer. All aggregates shall be sieved and washed with the clean water. The aggregates shall conform to the following specific requirements.

5.5.6 **Fine Aggregates:**

The grading and uniformity of fine aggregate as delivered to the mixers shall conform to the following requirements.

Sieve Designation U.S. / Standard Square Mesh.	Percent Passing
3/8" (9.5 mm)	100
No.4 (4.75 mm)	95 to 100
No.8 (2.36 mm)	80 to 100
No.16 (1.18 mm)	50 to 85
No. 30 (600 mm)	25 to 60
No. 50 (300 mm)	10 to 30
No. 100 (150 mm)	2 to 10

5.5.7 **Coarse Aggregate:**

The grading of the coarse aggregate within the separated size groups shall conform to the following requirements as delivered to the mixer:

U.S. Standard Sieve Size (Normal Size)	Percent by weight finer than each Laboratory Sieve			
	1/4" No. 4 Group	3/4" to No. 4 Group	1" to No. 4 Group	1-1/2" to No. 4 Group
2" (50 mm)	-	-	-	100
1.5" (37.5 mm)	-	-	100	95 - 100
1" (25 mm)	-	100	95 - 100	-
3/4" (19 mm)	100	90 - 100	-	35 - 70
1/2" (12.5 mm)	90 - 100	-	25 - 60	-
3/8" (9.5 mm)	40 - 70	20 - 55	-	10 - 30
No. 4 (4.75 mm)	0 - 15	0 - 10	0 - 10	0 - 5
No. 8 (2.36 mm)	0 - 5	0 - 5	0 - 5	-

5.5.8 **Particle Shape**

The shape of the particles in fine and coarse aggregate shall generally be spherical or

cubical. The quantity of flat and elongated particles in the separated size groups of coarse aggregate, as defined and determined by standard tests shall not exceed 15 percent by weight in any size group. A flat particle is one having a ratio of width to thickness greater than three. An elongated particle is one having a ratio of length to width greater than three.

- 5.5.9 The Contractor in planning his aggregate processing operations shall make whatever provisions are necessary, as regards methods and equipment, to ensure effective elimination of soft particles from all aggregates to the degree that the percentage of soft particles present in the processed coarse aggregate shall not exceed 3 percent by weight when determined in accordance with the applicable requirements of ASTM Designation C235-68 Standard Method of Test for Scratch Hardness of Coarse Aggregate Particles or other standard test. Test Samples shall be representative of the each size group of processed aggregate specified in sub-c 5.5.7 Coarse Aggregate, obtained according to the ASTM Methods D-75. Sizes of samples for each size group shall be as follows:

Size Group	Weight of Sample in Kilograms
----- ½" to No.4	1
¾" to No. 4	1
1" to No. 4	7
1-1/2" to No. 4	10

5.5.10 Uniformity of Coarse Aggregate:

If the Contractor prefers to use blended crushed stone and natural gravel, the uniformity of proportions of crushed gravel to natural gravel in any size group of coarse aggregate shall be maintained relatively constant and in no event exceed a variation of 5 percent plus or minus in either component of a combination of crushed and natural gravel in any 24 hours period of mixing operation, except No.4 to 3/4" group, for which a variation larger than plus or minus 5 percent will be permitted. The limit of the larger variation will be determined after the gradation of fine aggregate has been approved and after the first month of operation of the Contractor's aggregates processing arrangements.

5.5.11 Deleterious Substances:

- a] Fine Aggregate: The maximum percentages of deleterious substances in the fine aggregate, as delivered to the mixer, shall not exceed the following values:

Substances	Percent of Weight
Material passing No.200 Sieve	3
Shale	1
Total of other deleterious substances (such as mica, chlorite, coated grains, and soft flaky particles).	3

The sum of the percentages of all deleterious substances shall not exceed 5 percent, by weight

- b] Coarse Aggregate: The maximum percentages of deleterious substances in any size of coarse aggregate, as delivered to the mixer, shall not exceed the following values:

<u>Substances</u>	<u>Percent by Weight</u>
Material passing No. 200 Sieve	1
Shale	1
Clay lumps	1/2

The sum of the percentages of all deleterious substances in any size, as delivered to the mixer, shall not exceed 3 percent by weight.

Storage:

Aggregate shall be stored at the site in such a manner as to prevent its deterioration or the inclusion of foreign matter. Aggregate which has deteriorated or which has been contaminated shall not be used for concrete. All methods employed by the Contractor for loading, unloading, handling and stock-piling aggregates shall be subject at all times to approval of the Consultants. Sufficient aggregates shall be maintained at the site at all times to assure continuous placement and completion of any lift of concrete started.

5.5.12 Moisture Control:

All fine aggregate and smallest size group of the coarse aggregate shall remain in free draining storage at the site for at least 72 hours immediately prior to use. The free moisture content of the fine aggregate and of the smallest size group of coarse aggregate, as delivered to the mixer, shall be controlled so as not to exceed 4.0 and 1.0 respectively, expressed at percent by weight of the saturated surface dry aggregates unless higher limits are allowed. The moisture content of the other size of the coarse aggregates are delivered to the mixers with the least amount of free moisture and the least variation in free moisture practicable under the job conditions in addition to the limits on the maximum amounts of free moisture in aggregate, the moisture content shall be controlled so that for each size the variation in the percent of free moisture will not be more than 0.5 percent during any one hour of mixing plant operation. Under no conditions shall the aggregate be delivered to the mixed plant being dripping wet.

The Contractor shall carry out such tests as the Consultants may deem necessary to determine the free moisture content of aggregate.

5.6 WATER:

5.6.1 General:

Water for washing aggregates and for mixing and curing concrete shall be clean and free from injurious matters such as oil, acid, alkali, salt, organic matter, or other deleterious substances as determined by standard tests and selected by the Consultants In-charge. It shall meet the following chemical requirements:

Chlorides such as sodium chloride	max..	3000 ppm
Sulphates such as sodium sulphate	max.	2000 ppm
Impurities	max.	2 gm / litre
Melted salt	max.	15 gm / litre

The water for curing concrete should not have PH value lower than 5 and shall not contain impurities which cause discoloration of concrete.

5.7 PROPORTIONING OF CONCRETE: _____

5.7.1 Control:

The Contractor for the purpose of designing the mixes and for quality control will make trial mixes and tests. The Contractor shall cooperate and assist in obtaining samples and/or conducting field tests. The proportions of all materials entering into the concrete shall be as directed. The proportions will be changed whenever such change is necessary to maintain the standard of quality required for the structures covered by these Specifications and to meet the varying conditions encountered during construction. The Contractor will be

entitled to no compensation additional to that included in the prices for the applicable tender items in the Bill of Quantities because of such changes.

5.7.2 **Measurement:**

All materials used to produce the concrete shall be measured by weight or by volume as approved by the Consultants In-charge.

5.7.3 **Cement Content:**

The cement content of concrete for various parts of the structure shall be established by trial mixes depending on the structural requirements, water cement ratio, size, type and gradation of the aggregate used. If at a particular place there is so large a quantity of steel that it becomes difficult to get the concrete well around and between it, then the specified batch of the concrete consisting of smaller size of aggregate and increased quantity of cement shall be used to achieve the same strength as for normal concrete.

5.7.4 **Aggregate Content:**

The maximum size of aggregate to be used in the various parts of the structure shall be shown on the drawings and where not shown, shall be as directed. Concrete mixes shall be of coarse aggregate practicable in accordance with 5.5 above .

5.7.5 **Water Content:**

The amount of water to be used shall be governed by the following considerations:

i] **Water Cement Ratio:**

In general, the Consultants design will provide for water cement ratios by weight (exclusive of water absorbed by the aggregates), which will be determined on the basis of producing concrete having suitable workability, density, impermeability, durability and the required strength without the use of excessive amount of cement.

ii] **Consistency:**

The amount of water used in the concrete will be regulated as required to secure concrete of proper consistency taking into account the effect of any variation in either or both the moisture contents or grading of the aggregates as they enter the mixer. Addition of water to compensate for stiffening of concrete before placing will not be permitted. Uniformity in concrete consistency from batch to batch shall be ensured.

iii] **Concrete Strength:**

Concrete for different parts of structure shall have cylinder compressive strength at least equal to the minimum allowable strength shown in the following table except as otherwise indicated on the drawings or directed by the Consultants.

Class	28 days work compressive strength (Cube Strength)/Nominal Mix
E (1:4:8)	1000 psi
D (1:3:6)	1550 psi
C (1:2:4)	3000 psi
B (1:1.5:3)	4000 psi

iv] **Slump:**

In general, the slump of the concrete after concrete has been deposited but before it has been consolidated, shall not exceed the values specified below for the structures and/or parts thereof unless otherwise directed by the Consultants In-charge. Check slumps shall be taken at the mixer and at other locations as directed by the Consultants In-charge. The placement of concrete of such lesser slumps can be consolidated readily into place by means of the specified vibrations. The use of buckets, chutes, hoppers, or other equipment of types that will not readily handle and place concrete of such lesser slumps will not be permitted. The slump will be determined in accordance with ASTM Designation C143-74, Standard Method of Test for Slump of Portland Cement Concrete, except that the fraction of material larger than 1-1/2" (37.5 mm) thick be removed by wet screening.

Concrete Uses Slump

Slabs, Floors and foundations	2"
Walls, Columns, Parapets, Curbs etc.	3"

5.8 **ESTIMATE OF CONCRETE:**

5.8.1 **Strength Test During the Work:**

Strength tests of the concrete placed during the course of the work will be made by the Consultants In-charge in an approved laboratory at the Contractor's expense. The Contractor shall assist by the Consultants In-charge in obtaining such number of cylinders may be directed by the Consultants In-charge but in general, three sets of three cylinders and/or three sets of three beams, taken from each 100 cu.yds or fraction thereof or from each days pour, which ever is less, of each class of concrete placed, shall govern. Test specimens will be made and cured by the Contractor in accordance with the applicable requirements of ASTM Designation C31-69, Standard Method of Making and Curing Concrete Compressive and Flexural Test Specimens in the Field. Cylinders and beams will be tested by the Consultants In-charge in accordance with the applicable requirements of ASTM Designation C39-72, Standard Method of Test for Compressive Strength of Cylindrical Concrete Specimens and ASTM Designation C78-64, Standard Method of Test for Flexural Strength of Concrete (Using Simple Beam with Third Point Loading). The test result will be based on the average of the strength of the test specimens except that if one specimen in a set of three shows manifests evidence of improper sampling, moulding, or testing, the test result will be based on the average of the remaining two specimens.

The standard age of test will be 28 days, but 7 days test may be used at the discretion of the Consultants In-charge to establish the relation between the 7-days and 28 days strengths of the concrete as established by tests for the materials and proportions used. If the strength tests of the specimens cured under laboratory controls, for any portion of the work, falls below the minimum standard at 28 days required for the class of concrete used in that portion, the proportions of the constituents of the concrete may be changed by the Consultants In-charge as necessary to secure the required strength for the remaining portions of the work. If the average strength of the specimens cured under actual field conditions as specified here-in-before falls below the minimum allowable strength, changes may be made in the conditions for temperature and moisture under which the concrete work is being placed and cured as may be necessary to secure the required strength.

5.8.2 **Tests of Hardened Concrete:**

Where the results of the strength tests of the control specimens indicate that the concrete as placed does not meet Specification requirements or there is other evidence that the quality of the concrete is below Specification requirements, core-boring tests will be made by the Contractor in accordance with the applicable requirements of ASTM Designation C42-68, "Standard Method of obtaining and Testing Drilled Cores and Sawed Beams of Concrete".

If the concrete in the structure will be more than superficially wet under service conditions, the cores shall be immersed in water for at least 48 hours and tested wet. In the event that the core-boring test indicates that the concrete placed does not conform to the Drawings and Specifications measures as prescribed by the Consultants In-charge shall be taken to correct the deficiency. If a strength deficiency is found and is due to the Contractor's fault or negligence, the entire cost of the replacing faulty concrete shall be borne by the Contractor. Otherwise, payment for removing and replacing faulty concrete will be made under applicable items of the Bill of Quantities as determined by the Consultants In-charge.

5.8.3 Strength Relation:

Where cylinders are made by wet screening of concrete with aggregate greater than one and a half inches (37.5 mm) size such as three-inches (75mm) aggregate concrete, the cylinders will be required to have a compressive test strength greater than the allowable strength shown on the drawings, to indicate that the respective concrete in place in the work has the allowable strength shown. The design will be such as that the average strength of the specimens tested be greater than the allowable strength shown on the Drawings for the three inches (75 mm) aggregate concrete. Such increments over the allowable strengths shown will be established by the Consultants In-charge after the mix design has been done and prior to mixing of concrete, and will be approximately ten percent .

5.9 BATCHING AND MIXING: _____

5.9.1 Type and Capacity:

All concrete shall be produced in a batching and mixing plant. .

The size of batch and mix plant shall be such that the proposed arrangement shall produce sufficient quantity of concrete meeting with all the other requirements of these Specifications and the construction schedule. The batched materials shall be thoroughly combined into a uniform mixture before the addition of water. The water be added gradually and the mixers operated for adequate duration of time so as to obtain a thoroughly mixed concrete of uniform colour and quality.

5.9.2 Mixers:

Hand mixed concrete shall not be used; however, it may be allowed by the the consultant to be mixed in small mixers. The mixer provided by the Contractor shall be capable of combining the materials into a uniform mixture and of discharging this mixture without segregation. Mixers shall not be charged in excess of the capacity recommended by the manufacturer and shall not be recharged before completely discharging the previous batches. Excessive over-mixing requiring additions of water will not be permitted. The mixers shall be operated at a drum speed designated by the manufacturer. The mixers shall be maintained in satisfactory operating condition, and mixer drums shall be kept free of hardened concrete. Mixer blades shall be replaced when worn down more than 10 percent of their depth.

5.9.3 Water Batcher:

The Contractor shall provide a suitable water-measuring device, which will be capable of measuring water within the specified requirements for each batch. The mechanism for delivering water to the mixer shall be such that no leakage will occur when the valves are closed.

5.9.4 Location:

The concrete plant/mixer shall be installed at the site of the work at locations selected by the Contractor duly approved by the Consultants In-charge.

5.9.5 Arrangement:

Separate bins and compartments shall be provided for each size or classification of aggregate and port-land cement. The compartments shall be of ample size and so constructed that the materials will be separated under all working conditions. Batching equipment/arrangement shall be capable of delivering concrete within the following limits of accuracy:

<u>Material</u>	<u>Percent</u>
Cement	+ 1%
Water	+ 1%
Aggregate Smaller than 3/4"	+ 2%
Aggregate larger than 3/4"	+ 3%

5.9.6 Cooling:

Adequate cooling facilities shall be provided to ensure that the temperature of concrete when discharged from the mixers is sufficiently low to meet the temperature requirements. Cool mixing water, ice, pre-cooled aggregate, shading the stockpiles with roofing or any other arrangements may be used to accomplish the pre-cooling of the concrete. Any such approval shall not in any way relieve the Contractor of his responsibility of placing concrete at temperatures at or below the specified limits.

5.9.7 Scales:

Adequate and as approved weigh and volume-batching facilities as approved by the Consultants In-charge shall be provided by the contractor for the accurate measurement and control of each of the materials entering each batch of concrete. The accuracy of the weighing equipment shall conform to the requirements of applicable standards selected by the Consultants for such equipment. The weighing equipment shall be arranged so that the concrete plant operator and Consultants can observe dials or indicators.

5.9.8 Mixing Time:

The mixing periods specified below are predicated on proper control of the speed of rotation of the mixer and of the proper introduction of the materials into the mixer. The mixing time will be increased when such increase is necessary to secure the required uniformity and consistency of the concrete. The mixing time for each batch after solid materials are in the mixer drum, provided that all the mixing water is introduced before one fourth of the mixing time has elapsed, shall be as follows:

<u>Capacity of Mixer</u>	<u>Mixing Time</u>
Up to 2 cu. yds.	1-1/2 minutes
3 cu. yds.	2 minutes

5.9.9 Testing Facilities:

The Contractor shall provide a concrete compressive test machine, a set of standard sieves and other relevant control testing equipment and a working space for the inspector and a space suitable for use in the plastic testing of concrete and moulding of concrete tests specimens. Such specimen shall be subject to approval by the Consultants In-charge. The Contractor may at his discretion install a concrete compression test machine at site. In this case certain percentage of cylinder to be fixed by the Consultants In-charge from time to time shall be got tested from an approved laboratory for counter check at the Contractor's expenses.

5.10 CONVEYING:

Concrete shall be conveyed from mixer to the place of final deposit as rapidly as practicable, methods, which will prevent segregation or loss of ingredients and in accordance with ACI-304-73, Recommended Practice for Measuring, Mixing Transporting and Placing Concrete. Any wet batch hopper through which the concrete passes shall be conical in shape. There shall be no vertical drop greater than 6 feet except where suitable equipment is provided to prevent segregation and where specifically authorized. Belt conveyors, chutes, or other similar equipment will not be permitted either for conveying concrete except where the use of such equipment is approved in writing by the Consultants In-charge. Each type or class of concrete shall be visually identified by placing a colored tag or marker on the bucket as it leaves the mixing plant so that the concrete may be positively identified and placed in the structure forms in the desired position.

5.11 PLACING:

5.11.1 General:

Concrete placing shall follow the Recommended Practice for Measuring, Mixing, Transporting and placing Concrete, ACI 304-73. No concrete shall be placed until all form-work, reinforcement, installation of parts to be embedded, bracing of forms and preparation of surface involved in the placing and the method of placement have been approved by the Consultants In-charge. Approval of the method of placement proposed will not relieve the Contractor of his responsibility under the Contract.

Before concrete is placed, all surfaces upon or against which concrete is to be placed shall be free from standing water, mud, debris or loose material. All surfaces of form and embedded material that have become encrusted with dried mortar or grout from concrete previously placed shall be cleaned of all such mortar or grout before the surrounding or adjacent concrete is placed. The surface of absorptive materials against or upon which concrete is to be placed shall be moistened thoroughly so that the moisture will not be drawn from the freshly placed concrete. Concrete shall be worked into the corners and angles of the forms and around all reinforcement and embedded items without permitting the material to its final position in the forms. The depositing of concrete shall be regulated so that the concrete may be effectively compacted with a minimum of lateral movement into horizontal layers approximately 1.5 feet in thickness. No concrete that has partially been hardened or contaminated by foreign materials shall be deposited in the structure, nor shall re-tempered concrete be used unless approved by the Consultants In-charge. The surfaces of construction joints shall be kept continuously wet for at least eighteen hours during the twenty-four hours prior to placing concrete except as otherwise directed by the Consultants In-charge. All free water shall be removed and the construction joint shall be completely surface dry prior to placement of concrete. All concrete placing equipment and methods shall be subject to approval. Concrete placement will not be permitted when in the opinion of Consultants In-charge weather conditions prevent proper placement and consolidation.

Before placing concrete, care shall be taken to determine that all embedded items are properly placed as required under the Specifications and are firmly and securely fastened in place as indicated on the Drawings, or as required. Embedded items shall be free of oil and other foreign matter such as loose coatings of rust, paint, and scale. The embedding of wood or other foreign materials in concrete is prohibited.

5.11.2 Time Interval Between Mixing & Placing:

Concrete mixed in stationary mixers and transported by non-agitating equipment shall be placed within thirty minutes after it has been mixed, unless otherwise authorized. When a truck mixer or agitator is used for transporting concrete, the concrete shall be delivered to the site of the work and discharge shall be completed within 1-1/2 hours after introduction of the cement to the aggregates. The concrete shall be placed within 20 minutes after it has been discharged. In all cases, concrete shall be placed and compacted well within the initial setting time.

5.11.3 Placing Temperature:

Placing temperatures shall conform to the requirements herein specified for thin sections, moderate sections and mass concrete. The Consultants's determination as to the type of section and applicable placing temperatures shall govern. Concrete shall be placed at temperatures as follows:

ThickThin
Sec.Sec.

o40oCMax. Temperature30 C
05oCMin. Temperature05oC

- i] THIN SECTIONS: Concrete for thin sections shall be delivered to the forms at the coolest temperature which is practicable to produce under current conditions but in no case at a temperature in excess of 32 degree centigrade except as otherwise determined by the Consultants. Sections to which this provision shall apply will be considered to be sections 2.3 feet or less in thickness.
- ii] MASS CONCRETE: Mass concrete shall have temperature of not more than 21 degree centigrade when placed. Mass concrete will be the one that is greater than 2.3 feet in thickness.

5.11.4 Lift in Concrete:

Concrete shall be installed in lifts or depths as shown on the drawings. The placement of concrete shall be carried on at such a rate and in such a manner that formation of cold joints is prevented. Slabs shall be placed in sections not exceeding 3600 sq.ft. (350 sq.m) unless otherwise authorized or directed. In walls, columns etc. lifts shall terminate such levels as will conform to structural details. Where slabs and beams are placed continuously with walls and columns, the concrete in walls and columns shall have been in place for at least three hours or for a longer period before placing concrete in the slabs and beams. The top surface of vertically formed lifts shall be generally level. The concrete in columns shall be placed in one continuous operation, unless otherwise authorized. In general, the construction joints in beams and slabs shall be located at mid span in both the directions as shown on the drawings and concrete shall be placed in the sequence indicated on the drawings or as authorized. The maximum differential in height between the various pours of the structure shall be as shown on the drawings or as directed.

5.11.5 Elapse Time between Placement of Lifts:

Except as otherwise approved on the basis of lift drawings submitted by the Contractor, a minimum of 72 hours shall elapse between the placing of successive lifts of walls and thin sections and 120 hours shall elapse between placing lifts of moderate sections and mass concrete. Thin sections and mass concrete have been defined in sub 5.11.3.

5.11.6 Time between adjacent Pours:

The time between adjacent pours shall be defined as the time elapsing from the end of the striking off of one pour to the start of placing the next pour. The minimum time elapsing between adjacent pours shall be 120 hours for mass concrete and 72 hours for all other concrete.

5.11.7 Placing Concrete through Reinforcement:

In placing concrete through reinforcement, care shall be taken that no segregation of the coarse aggregate occurs. In certain cases, like the bottom of beams and slabs, the congestion of steel near the forms may make placing difficult. In such cases, a layer of mortar of a composition compatible with the required concrete strength shall be first deposited to cover the surface to a depth of approximately 5/8".

5.11.8 Vibration of Concrete:

Recommended Practice for Consolidation of Concrete, ACI 309-72 shall be followed for concrete consolidation. Concrete shall be compacted with mechanical vibrating equipment supplemented by hand spading and tamping. In no case shall vibrators be used to transport concrete inside the forms. The vibrating equipment shall be of the internal type and shall at all times be adequate in number of units and power of each unit to properly consolidate all concrete. Form or surface vibrations shall not be used unless specifically approved. The intensity (amplitude) of vibration shall be sufficient (frequency not less than 8,000 impulses per minute) to produce satisfactory consolidation. The duration of vibration shall be limited to that necessary to produce satisfactory consolidation. Excessive surface working will not be permitted.

5.12 FORMS:

5.12.1 General:

Forms shall be true to line and grade, mortar tight and sufficiently rigid to prevent objectionable deformation under load. Where forms for continuous surfaces are placed in successive units, care shall be taken to fit the forms over the completed surfaces so as to obtain accurate alignment of the surface and to prevent leakage of mortar. Responsibility for their adequacy shall rest with the Contractor, however, the type, shape, size, quality and strength of all materials of which the forms are made shall be subjected to specific approval. Bolts and rods used for internal ties shall be so arranged, that when the forms are removed, metal will not be less than 2" (50 mm) away from any concrete surface. Whenever form ties are used, their arrangement and spacing shall be in a regular pattern, in accordance with the dimensions of the form-work panels and as instructed. Wire ties will not be permitted where the concrete surface will be exposed to weathering and where discoloration will be objectionable. Depressions resulting from removal of the form ties shall be filled in accordance with the provisions of C 5.14 "Repair of Concrete". Suitable openings as required shall be provided in the form-work for the passage of piping ducts, channels etc. All forms shall be so constructed that they can be removed without damaging the concrete. All exposed joints, edges and external corners shall be chamfered 1-1/2" (27.5mm) at 45 degrees except as otherwise shown. Internal corners shall be filleted where indicated or required. Forms to be used more than once shall be maintained in serviceable condition and shall be thoroughly cleaned before reuse.

5.12.2 Coating:

Shortly before concrete is placed, forms for exposed surfaces shall be coated with approved non-staining form oil, which shall not interfere with the set of the concrete nor be otherwise deleterious. After oiling, surplus oil on the form surfaces and any oil on the reinforcing steel or other surfaces requiring bond with the concrete shall be removed. Forms for unexposed surfaces may be thoroughly wetted, in lieu of oiling, immediately before the placing of concrete.

5.12.3 Removal:

The Contractor shall be responsible for ensuring that sufficient time has elapsed for the concrete to attain sufficient strength before removal of forms but no forms may be removed without prior approval. Forms shall be removed with care so as to avoid injury to concrete. Forms shall be removed as soon as practicable keeping in view the minimum time requirements, to avoid delay in water curing and to enable earliest practicable repair of surface imperfections. In order to avoid excessive stresses in the concrete that might result from swelling of the forms, wood forms for wall openings shall be loosened, as soon as this can be accomplished without damage to the concrete. Forms for the openings shall be constructed in such a manner as to be removed until the strength of the concrete is such that form removal will not result in perceptible cracking, spalling and breaking of edges of surfaces or other damage to the concrete. In general, the approximate

elapsed time before removal of forms shall be as stated below. However it should have attained a minimum of 70% of the specified work strength depending upon the type of the structure poured:

Beams and slabs	14 days
Columns and walls	36 hours
Mass concrete	24 hours

5.13 TOLERANCES FOR CONCRETE CONSTRUCTION:

Permissible surface irregularities for the various classes of concrete surface finish as specified in C 5.15 "Finishes and finishing", are defined as finishes, and are to be distinguished from tolerances as described herein. In general, the permissible construction tolerances for reinforced concrete shall conform to the requirements of the following tables, as applicable. The specific tolerances for each structure and part thereof shall be as determined. Notations on the drawings, if indicated, of specific maximum or minimum tolerances in connection with any dimension shall be considered as supplemental to the tolerances specified herein and shall control. The Contractor shall be responsible for setting and maintaining concrete forms sufficiently within the tolerance limit so as to ensure that the completed work will be within the tolerances specified herein. Concrete work that exceeds the tolerance limits specified herein shall be remedied or removed and replaced by and at the expense of the Contractor.

1. Variation from Plumb:
 - A. In the lines and surfaces of columns, piers, walls, and in arises: In any 10 feet of length.. 1/4"
Maximum for the entire length. 3/4"
 - B. For exposed corner columns, control-joint grooves, and other conspicuous lines:
In any 20 feet 1/4"
Maximum for the entire length 1/2"
2. Variation from the level or from the grades specified.
 - A. In slab soffits, ceilings, beam soffits and in arises, measured before removal of supporting shores:
In any 10 feet of length. 1/4"
In any bay or in any 20 feet of length. 3/8"
Maximum for the entire length. 3/4"
 - B. In exposed lintels, sills, parapets horizontal grooves and other conspicuous lines:
In any bay or in 20 feet of Length. 1/4"
Maximum for the entire length. 1/2"
3. Variation of the linear building lines from established position in plan and related position of columns, walls and partitions:
In any bay 1/2"
In any 20 feet length 1/4"
Maximum for the entire length 1"
4. Variation in the sizes and location of sleeves, floor openings, and wall openings... + 1/4"
5. Variation in cross-sectional dimensions of columns and

beams and in the thickness of slabs and walls.

Minus	1/4"
Plus	1/2"

6. Footings:

A. Variations in dimensions in plan:

Minus	1/2"
Plus	1/2"

B. Misplacement of eccentricity:

2 percent of the footing width in the direction of misplacement but not more than 2"

C. Thickness:

Decrease in specified thickness.	5-percent (5%)
----------------------------------	----------------

7. Variation in steps:

A. In a flight of stairs: Rise	1/8"
Tread	1/4"

B. In consecutive steps:

Rise	1/16"
Tread	1/8"

5.14 REPAIR OF CONCRETE

5.14.1 General:

Concrete that is damaged from any cause, concrete that is honeycombed, fractured, or otherwise defective, and concrete which because of excessive surface depressions, must be excavated and built up to bring the surface to the prescribed lines; shall be removed and replaced with dry-pack, mortar, or concrete as hereinafter specified. Repair of concrete shall be performed only by skilled workmen and within 24 hours of removal of forms, the contractor shall keep the Consultants advised as to when repair of concrete will be performed unless inspection is waived in such specific case required.

5.14.2 Materials

All materials used in the repair of concrete shall conform to the applicable requirements of the Specifications herein before stated.

5.14.3 Protrusions:

Where bulges and abrupt irregularities protrude outside the specified limits on formed surfaces not to be concealed permanently, the protrusions shall be reduced by bush hammering and grinding so that the surfaces are within the specified limits.

5.14.4 Depressions:

All fillings for depressions shall be boned tightly to the surfaces of the holes and shall be sound and free from shrinkage cracks and dummy areas after the fillings have been cured and have dried. All filling in surfaces of view shall contain sufficient white port-land

cement to produce the same color as that of the adjoining concrete. Repairs shall be made with concrete filling, mortar filling, or dry-pack filling except where repairs with epoxy concrete and/or epoxy mortar are directed to be made. Concrete, mortar and dry-pack mortar filling shall each be mixed in approved proportions to produce a repair at least equivalent in strength, density and durability to the concrete in which the repair is required.

5.14.5 Concrete Filling:

Concrete filling shall be used for holes extending entirely through concrete section; for holes in which no reinforcement is encountered and which are greater than 1.1 sq.ft. and deeper than 4" (100 mm) and for holes in reinforced concrete which are greater in area than 0.55 sq.ft. and which extend beyond reinforcement.

5.14.6 Mortar Filling:

Mortar filling, placed under impact by use of a mortar gun, may be used for repairing defects on surfaces, not exposed to view where the defects are too wide for dry-pack filling and too shallow for concrete filling and no deeper than the far side of the reinforcement that is nearest the surface.

5.14.7 Dry-pack Mortar:

Dry-pack mortar fillings shall be used for filling holes having a depth nearly equal to, or greater than, the least surface dimensions; for narrow slots cut for repair of crack; for grout pipe recesses; and for ties and faster recesses as specified. Dry pack mortar shall not be used for filling holes behind reinforcement that extend completely through a concrete section. If removal of the form ties results in recesses, the recesses shall be filled with dry pack mortar provided that filling of recesses in surfaces upon or against which fill material or concrete is to be placed will be required only where the recesses are deeper than 1" (25 mm) in walls less than 1 ft. (.3 m) thick.

5.14.8 Surface Finishes of Patched Area:

The Contractor shall correct all imperfections on the concrete surfaces as necessary to produce surfaces that conform to the requirements specified for the adjacent area in C 5.15 "Finishes and Finishing". Unless otherwise approved, repair of imperfections in formed concrete shall be completed within 24 hours after removal of forms. Fins and encrustations shall be neatly removed from surfaces.

5.15 FINISHES

5.15.1 General:

Allowable deviations from plumb or level and from the alignment profile grades and dimensions shall be as shown on the drawings or as specified in C 5.13. Tolerances for Concrete Construction, are defined as tolerances and are to be distinguished from irregularities in finishes as described herein. The classes of finish and the requirements for finishing of concrete surfaces shall be as generally specified in this c and as indicated on the drawings. Only workmen who are skilled concrete finishers shall perform finishing of concrete surfaces. Concrete will be tested where necessary to determine whether surface irregularities are within the limits hereinafter specified. Surface irregularities are classified as abrupt or gradual. Offsets caused by displaced from or misplaced from sheathing or lining or form sections, or otherwise defective form number will be considered as abrupt irregularities, and will be tested by direct measurements. All other irregularities will be considered as gradual irregularities, and will be tested by use of a template, consisting of a straight edge or the equivalent thereof for curved surfaces. The finish for concrete surfaces shall be as shown on the drawings or as directed. Interior surfaces shall be sloped for drainage where shown on the drawings or directed. Surfaces which will be exposed to weather and which would normally be level, shall slopes or level surfaces is indicated on the

drawings or directed, narrow surfaces, such as tops of walls shall be sloped approximately 3/8" per foot. No grinding will be required on such formed surfaces other than that necessary for repair of surface imperfections.

5.15.2 Ordinary Finish:

Ordinary finish (OF) applies to surfaces upon or against which fill material or concrete is to be placed. If unformed, the finishing operation shall consist of sufficient leveling and screeding to produce even uniform surfaces. When formed, the surfaces require no treatment after form removal except for repair of defective concrete and filling of holes left by the removal of fasteners from the end of the tie rods as required under C 5.14 "Repair of Concrete". Correction of surface irregularities shall be required for depressions only and only for those, which exceed 1 inch when measured as described in related clause.

5.15.3 Rough Concrete Finish

Rough concrete finish (RC) applies to surfaces, which are intended to receive tiles or cement plaster as indicated on the drawings. After consolidation and leveling of concrete to the specified tolerances, the surface shall be roughened with stiff brushes or raked before final set. Where rough concrete finish is specified for wall surfaces, the same shall be obtained by use of formwork suitable to produce the required finish. Surface irregularities measured as described in relevant clause "General" shall not exceed 3/8" for floor and 2/8" for walls.

5.15.4 Ordinary Slab Finish

If allowed by the Consultant ordinary slab finish applies to floor surfaces, which are intended to receive tiles and other floor coverings, or without any coverings, as indicated. When the concrete surface has stiffened sufficiently, floating shall be performed by use of hand or power driven equipment, and shall be minimum necessary to produce a surface that is free from screed marks and is uniform in texture. Floating shall be continued until a small amount of mortar without excess water is brought to the surface so as to permit effective trowel ling. Steel trowel ling shall be started when the floated surface has hardened sufficiently to prevent excess of fine material from being drawn to the surface. Steel trowel ling shall be performed with firm pressure such as will flatten the Sandy texture of the floated surface and produce a dense uniform surface, free from blemishes and trowel marks. Surface irregularities measured as described in sub C 5.15.1 general, shall not exceed 3/8".

5.15.5 Fair Finish

All the concrete must be fair faced (FF) plaster like finish by using fresh steel formwork and shuttering and the steel moulded shuttering for beams and columns must be fabricated and used by the contractor leaving smooth surface FF. applies to the exposed formed surfaces, the appearance of which is considered by the Consultants of special importance such as overhead reservoirs, waffle slabs, Tee beams and other places shown on the drawings and the finish Schedule. Surface irregularities measured as described in related sub-clause, General, shall not exceed 6mm (1/4") for the gradual irregularities and 3mm (1/8") for abrupt irregularities, except that the abrupt irregularities will not be permitted on the construction joints. Abrupt irregularities at he construction joints, abrupt irregularities elsewhere in excess of 1/4" of an inch shall be rendered, by grinding to conform to the specified limits. Abrupt irregularities shall be ground on a level 1 to 20 ratio of height to length. Fair face means no touch afterwards.

5.16 CURING CONCRETE

5.16.1 General:

All concrete shall be cured by an approved method or combination of methods in accordance with ACI 308-71 and in this section, "Recommended Practice for Curing Concrete". The Contractor shall have all equipment and materials needed for adequate curing and protection of the concrete on hand and ready to use before actual concrete placement begins. Means shall be provided for the protection of concrete from the sun,

drying winds, and traffic until the specified curing has been completed. The curing medium and method, or the combination of mediums and methods used, shall be subject to approval in writing by the Consultants. The curing medium shall be applied so as to prevent loss of moisture from the concrete. Concrete shall be protected from heavy rains for 24 hours and direct rays of the sun for 14 days. All concrete shall be adequately protected from damage. No fire or excessive heat, including the heat resulting from the welding of any sort or reinforcing bars etc., shall be permitted near or in direct contact with concrete at any time. All galleries, conduits and other formed openings through the concrete shall be closed during the entire curing period.

5.16.2 Moist Curing:

Unless otherwise approved by the Consultants, the concrete shall be moist-cured by maintaining all surfaces continuously (not periodically) wet for at least 14 days immediately following the placing or until covered with fresh concrete. Curing water shall be removed without allowing stagnant pools of water to form on the exposed lift surface. Water for curing shall comply with the applicable requirements of relevant Clause. Surfaces of concrete, which are to be permanently exposed, shall be cleaned if a water is used which stains the surfaces during curing. Where forms of tongue-and-groove or ship-lap sheeting are used and are left in place during curing, the sheathing shall be kept, at all times, when in contact with mass concrete, steel forms shall be kept wet. Horizontal construction joints and finished horizontal surfaces cured with sand which shall be covered with a minimum uniform thickness of 50 mm (2 inch) of sand which shall be kept continuously saturated. The following exceptions to the requirements for moist curing are permitted:

- i) Horizontal construction joints may be allowed to dry for six hours immediately prior to placing of the following lift:
- ii) Moist curing of surfaces, against which back-fill is to be placed within 24 hours of concrete placement, will not be required:

5.17 PLACING REINFORCEMENT:

5.17.1 Supports:

Reinforcement, pre-stressing steel and ducts, shall be accurately placed and adequately supported before concrete is placed, and shall be secured against displacement within permitted tolerances. Welding of crossing bars shall not be permitted for assembly of reinforcement unless authorized.

5.17.2 Tolerances:

Unless otherwise specified, reinforcement, pre stressing steel, and prostrating steel ducts shall be placed within the following tolerances:

For concrete protection and for depth, d in flexural members, walls, and compression members where d is:

8" or less+1/4"

More than 8" but less than 24"+3/8"

24" or more+1/2"

but the cover shall not be reduced by more than one-third of specified cover.

For longitudinal location of bends and ends of bars: + 2" except at discontinuous ends of members where tolerance shall be + 1/2".

5.17.3 Draped Fabric:

When welded wire fabric with wire of 1/4" diameter or less is used for slab reinforcement in slabs not exceeding 10' in span, the reinforcement may be curved from a point near the top

of the slab over the support to a point near the bottom of the slab at mid span, provided such reinforcement is either continuous over, or securely anchored at, the support.

5.18 MEASUREMENT

For any item of work constructed under this section, measurement shall be made by volume. The unit of measurement shall be made on cu.ft./m. In computing the concrete quantity the dimensions used shall be the plan dimensions of the concrete with the neat lines shown on the plans except that no deduction will be made for weep holes and floor drains and no account shall be taken of chamfers, scorings, fillets of 4 cm radius or less in cross section area.

The quantity to be paid for shall be the original plan quantity, measured as provided above, except that where the plans call for an estimated quantity of miscellaneous concrete for contingent use such contingent concrete shall be measured as the actual quantity by the in-place and accepted.

No measurements for or other allowances will be made for work or material for forms/shuttering, false work, pumping, bracing, etc. The volume of all material embedded in the concrete such as structural steel, pile heads, etc. except reinforcing steel, shall be deducted in computing the volume of concrete to be paid for.

.....End of Section.....

6.1 DESCRIPTION

The work to be done under this Section shall include furnish, cut, bend, and place all steel reinforcement as indicated on the Drawings or otherwise required. All reinforcement when surrounding concrete is placed, shall be free from loose, flaky rust, and scale, and free from oil grease or other coating, which might destroy or reduce its bond with the concrete. All placing shall be in accordance with Drawings furnished or approved. The use of reinforcement for the transmission of current for welding will not be permitted. All reinforcement, including dowels, remaining exposed in the work shall be suitably protected until embedded in concrete.

6.2 CUTTING AND BENDING

Steel reinforcement may be mill or field cut and bent. All bending shall be in accordance with standard approved practice and by approved machine methods. When bending is required, it shall be performed prior to embedding the bars in the concrete. In all such cases, the bars shall be cold bend. Bending or straightening of bars partially embedded in set concrete shall not be permitted except in isolated cases where corrective action or a field change is required and is so specifically approved by the Consultants.

Reinforcement shall not be bent or straightened in a manner that will injure the material. Special care shall be taken to ensure accurate bending of reinforcement for small and thin members, particularly in respect of binders.

Bending hot at a cheery-red heat (not exceeding 840 degree centigrade) will be allowed for mild steel bars. Quenching should not cool bars bent hot.

6.3 QUALITY

Concrete reinforcement bars shall be of following quality:-

- a) Cold worked steel bars for concrete reinforcement shall conform to BS 4461:1969 embedded to date.
- b) Deformed steel bars (Tor Steel) for concrete Reinforcement shall be Grade-60 conforming to ASTM 615-80.

The Contractor shall provide labour, materials; arrange fabrication and fixing measuring and testing facilities to ascertain quality, weight or quantity, quality of steel at his own expense. No steel shall be incorporated in the work without prior approval of he Consultants incharge.

6.4 PLACING AND POSITIONING

Reinforcement shall be placed and maintained within the specified tolerance of its position shown on the drawings. Where practicable, it is recommended that the reinforcement be performed into rigid cages, spot welding being permissible for this purpose.

Where tying wires or clips are used, care should be taken to ensure that the projecting ends do not encroach into the concrete cover. Strict and constant vigilance must be exercised to ensure that the reinforcement is maintained in its correct position at all stages and for all methods of placing and compacting the concrete. Normally, spacing blocks used for this purpose shall be made of mortar comparable in strength and durability with the main concrete.

Other kinds of spacers shall be of a proved and agreed type, suitable for the conditions to which the unit will be exposed.

6.5 RELATION TO BARS TO CONSTRUCTION SURFACES

The cover of all main reinforcement shall be as specified or shown on the Drawings. The dimensions, as shown on the drawings, indicate the clear distance from the edge of the main reinforcement to the concrete surface. The concrete covering of stirrups, spacer bars, and similar secondary reinforcement may be reduced by the diameter of such bars. The actual concrete cover to all steel at any point shall not be less than the required nominal cover by more than 1/8".

The effective depth of fully or nearly fully stressed tensile reinforcement shall not be less than that given on the Drawings by an amount exceeding 5 percent of the effective depth of the section being considered or 1/4" whichever is the greater. Due regard should be paid to the reinforcement of BSS 4466.

6.6 SPLICING

Except as otherwise shown on the Drawings or specified herein, all splices, lengths of laps, splice locations, placement and embedment of reinforcement shall conform to the applicable requirements of American Concrete Institute 318-83, Building Code Requirements for Reinforced Concrete. All splices and locations of laps in reinforcement shall be as shown on the Drawings or as directed by the Consultants. Additional bar splices shall be provided as required, subject to approval of the Consultants. Lapped ends of bars may be placed in contact and securely wired or may be separated sufficiently to permit the embedment of the entire surface of each bar in concrete. If welded splices are proposed, welder of approved qualification and experience shall be employed after obtaining proper approval of the Consultants In-charge on proformas to be obtained from the Consultants In-charge. Sufficient number of welds shall be tested to failure in each lot to maintain a check on the quality at the cost of the Contractor.

All reinforcement shall be secured in place by use of metal or concrete supports, spacers, or ties, as approved by the Consultants In-charge. Such supports shall be of sufficient strength to maintain the reinforcement in place throughout the concreting operation. The supports shall be used in such a manner that they will not be exposed or contribute in any way to the discoloration or deterioration of the concrete. Concrete supports shall be manufactured of the same concrete mix as used in the structure to be concreted.

6.7 TOLERANCES

Following tolerances shall be observed :

6.7.1 Bars used for concrete reinforcement shall meet the following requirements for fabricating tolerances:

- a) Sheared length +1 in.
- b) Depth of truss bars +0 - 1/2 in.
- c) Overall dimensions of stirrups, ties, and spirals + 1/4 in.
- d) All other bends + 1 in.

6.7.2 Bars shall be placed to the following tolerances:

- a) Clear distance to formed surface 1/4 in.
- b) Minimum spacing between bars 1.4 in.
- c) Top bars in slabs and beams:
 - i) Members 8 in. deep or less + 1/4 in.

- d) ii)Members more than 8 in. but not over 2 feet deep
Crosswise of Members + 1/2 in.
Spaced evenly within 2 in.
- e) Lengthwise of Members +2 in.

6.7.3 Bars may be moved as necessary to avoid interference with other reinforcing steel, conduits or embedded items. If bars are moved more than one bar diameter, or enough to exceed the above tolerances, the resulting arrangement of bars shall be subject to approval.

6.8 EMBEDMENT ITEMS

Before placing concrete, care shall be taken to determine that all embedded items are properly placed as required under the Specifications and are firmly and securely fastened in place as indicated on the Drawings, or as required. Embedded items shall be free of oil and other foreign matter such as loose coatings of rust, paint, and scale. The embedding of wood or other foreign materials in concrete is prohibited.

6.9 MEASUREMENT

Measurement will be made of the number of tons of reinforcing steel acceptably placed on the basis of the lengths of bars installed in accordance with the approved Drawings or bar schedules or as directed, converted to weights for the size of bars lists by the use of actual weights or unit weights per linear feet as follows :

Bar Designation	Nominal Unit Weight Lbs. Per Foot.	_____
#30.376		
#40.668		
#51.043		
#61.502		
#72.044		
#82.670		
#93.400		
# 104.303		
# 115.313		
# 147.650		
# 1813.600		

- Unless otherwise specifically stated in the Bill of Quantities or herein, all items of reinforcement shall be deemed to be inclusive of, but not limited to the following :-
- Reinforcement bar bending schedule to be provided by the Contractor for approval from the consultant.
- Providing materials, attendance and costs for all sampling and testing.
- Cost of M.S. binding wire and concrete, metal or plastic chairs and spacers or hangers.
- Cleaning, cutting and bending, placing and fixing in position including binding with wire and other material and placing supports and spacers.
- All sorts of transportation involved in the process.
- All reinforcement shall be provided in lengths shown in drawings and as per Specifications. Should the CONTRACTOR provide lengths of reinforcement, which are greater than shown on the drawings, no payment for extra lengths shall be made.
- Steel to used in Overlaps, chairs, pins or any other steel quantity required for fixing , positioning and alying the steel reinforcement not be allowed to be paid to the contractor and measured or as related item of BOQs.

.....End of Section.....

7.1 DESCRIPTION

The Damp Proof Course shall be horizontal and vertical as shown on the drawings and specified in the Bill of Quantities.

7.2 HORIZONTAL7.2.1 In Walls

The horizontal D.P.C. shall consist of 2" -thick, Class-C (1:2:4) cement concrete cast in situ, applying 2-coatslayers of hot bitumen SIB (Specified Industrial Bitumen) 10/20 grade @ 20 lbs./100 Sft. each coat, including fixing of 5 mm thick fabric based 0.5 mm thick aluminum foiled impregnated bituminous sheet.

7.2.2 Under Floors

Same as in walls except bitumen layers to be laid on 1/2" - 3/4" blinding screed (1:6) to even out surface of Class-E hard core.

7.3 VERTICAL

The vertical D.P.C. shall consist of 3/4" thick 1:3 cement sand mortar with fabric based, 0.5 mm thick Aluminum foil, impregnated bituminous sheet .

7.4 MATERIAL REQUIREMENTS

All materials i.e. cement, sand, aggregate, water, polythene sheet, bitumen and of 5 mm thick fabric based 0.5 mm thick aluminum foiled impregnated bituminous sheet of 5 mm thick fabric based 0.5 mm thick aluminum foiled impregnated bituminous sheet conform to the specifications given in respective section.

7.5 CONSTRUCTION REQUIREMENTS(i) Horizontal DPC

The Contractor shall lay the D.P.C. only when the levels, quality of masonry work, etc. is approved.

The concrete work of D.P.C. shall conform to the relevant specifications given in this section for the execution of these items.

Horizontal D.P.C. shall extend to the full width of the wall i.e. up to the external faces. No portion of doors opening, etc. shall be left while laying D.P.C. The period of curing of concrete shall be not less than 72 hours. Every care should be taken that concrete is not left dry during this period. The work of laying Damp Proof Course shall be carried out as follows unless otherwise described in BOQ:-

- a) Placing 2"- thick layer of Class-C (1:2:4) cement concrete.
- b) Laying 2 coats of hot bitumen S.I.B. 10/20 grade @ 20 lbs. per % sq.ft. (each coat) over entire width and lengths of concrete after the concrete has been properly cured for at least 72 hours, and after the approval of Consultants In-charge.

- c) Laying of of 5 mm thick fabric based 0.5 mm thick aluminum foiled impregnated bituminous sheet over entire width and length of concrete after the concrete has been treated with 2 coats of hot bitumen.

(ii) Vertical DPC.

The Contractor shall apply the Vertical D.P.C. only when the levels, quality of masonry work, dust free surface is checked and approved by the Consultants In-charge.

The Plaster/mortar work of Vertical D.P.C. shall conform to the relevant specifications given in this section for the execution of these items.

Horizontal D.P.C. shall extend to that height/depth of the wall as specified in the drawings or directed by the Consultants In-charge i.e. for the external faces or as directed by the Consultants In-charge. No portion of doors opening, etc. shall be left while laying D.P.C. The work of laying Damp Proof Course shall be carried out as follows unless otherwise described in BOQ:-

- a) Applying 3/4"- thick layer of C/S Mortar/plaster.
- b) Laying 2 coats of hot bitumen S.I.B. 10/20 grade @ 20 lbs. per % sq.ft. (each coat) over entire specified depth/height after cleaning the surface of Brick masonry, and after the approval of Consultants In-charge.
- c) Laying of of 5 mm thick fabric based 0.5 mm thick aluminum foiled impregnated bituminous sheet over entire specified depth/height after the brick masonry has been treated with 2 coats of hot bitumen.

7.6 MEASUREMENT AND PAYMENT

Measurement

The measurement shall be made in per sq.ft./ sq. m. by measuring length and breadth/height of actual works done (except overlaps in polythene, fabric based aluminum foiled sheet or any other material used for damp proofing) and as shown on the drawings and as directed by the Consultants.

.....End of Section.....

8.1 DESCRIPTION

The work under this Section shall include all type of brickwork in foundation, super structure; fair face brick cladding, special formed bricks/cut bricks/ Brick Jali, Facia drains manholes and elsewhere as shown on the drawings.

The brickwork wherever referred to shall be first class brickwork. Unless otherwise specified the work shall be carried out in English bond or as shown on drawings and as directed by the Consultants Incharge.

8.2 MATERIAL REQUIREMENTS

Unless otherwise specified or directed all materials, i.e. bricks, sand, cement and water, etc. shall conform to specification given in the Section-I " Materials and in the relevant item of BOQ's.

8.2.1 Mortar

The ratio of cement (ordinary Portland Cement or Sulphate resisting cement as directed) Sand mortar to be used for brickwork shall be as specified in the BOQ and as per drawings.

8.2.2 Preparation of Mortar

Cement and sand shall be thoroughly mixed in dry state on a pacca platform or on metallic sheets or trough Water shall be added in sufficient quantity to make the mortar workable. Water shall be added in a manner so that segregation of cement does not take place. Mixing of mortar shall produce a homogenous workable mass.

Precautions

- a) Only such quantity of mortar shall be prepared as can be used before the initial setting time of cement.
- b) Any mortar, which has initially set, shall not be used.
- c) At the close of day's work the mixing troughs pans or platforms shall be thoroughly washed and cleaned.
- d) Accurately control and maintain specified proportions.

8.2.3 REINFORCING AND ANCHORS

Joint Reinforcing

As per BOQ and advice of he Consultants In-charge.

8.3 CONSTRUCTION REQUIREMENTS

8.3.1 Precautions

- a] Erect no masonry when the ambient temperature is 40 degrees centigrade or less except by permission. Build upon no frozen work and lay no masonry having a firm of frost on their surfaces.
- b) Should cuts be required in walls for the passage of conduit etc. the entire cut out shall be filled with mortar.

8.3.2 Selection of Bricks

The bricks shall be selected for face work before incorporating in the work. The brick for the face work in particular shall be of uniform size shape even colour and smooth texture. No extra payment shall be made for such selection of bricks or extra fair face work unless otherwise provided in the B.O.Q. The special formed bricks or cut bricks or brick Jali or fair face brick cladding will as per their relevant BOQ's item and as directed by the Consultants Incharge.

8.3.3 Soaking of Bricks

Before use all bricks shall be soaked in clean water in a tank for at least two hours.

8.3.4 Bond

Unless otherwise specified all bricks shall be laid in English bond with frogs upward.

8.3.5 Tools

All equipment used for mixing mortar, transporting it and for laying bricks shall be clean and free from set mortar, dirt, or other injurious foreign substances. It shall be thoroughly cleaned, at the end of each day's work.

8.3.6 Progress

Brickwork shall be carried up in a uniform manner. No portion shall be raised more than 3 feet above another at the same time. Temporary spaces left during construction shall be stepped and not toothed. Straight edges supplied to brick layer shall have courses marked on them with saw cut or measuring rod shall be provided and layer of courses shall be checked all over the building from time to time so as to help all courses level.

8.3.7 Fixtures

Holdfasts and similar fixtures shall be built in with in surrounding brickwork in their correct position in specified mortar. They shall be built in as the work progresses and not inserted later on into space left for them.

8.3.8 Laying of Bricks

Each brick shall be set with both bed and vertical joints properly filled with mortar and thoroughly bedded. Thickness of joints shall not be less than 1/4" (6 mm) and shall not more than 1/2" (12 mm). The height of 4 courses and 3 joints as laid shall not exceed 1" (25 mm) in height of 4 bricks piled dry one upon the other.

No half bricks or bats shall be used except where necessary to complete the bends etc. At corners alternate Courses of bricks shall be laid header-wise and stretcher-wise, so as to bind the two walls together. All brickwork shall be truly plumbed and each set of four brick courses shall be checked with plumbed and straight edges. The joints of brickwork, which is to be pointed or plastered, shall be raked out to a depth of half an inch (12 mm). The raking shall be done before the mortar sets each day. All anchors, ties and reinforcing shall be placed where required. Unless otherwise specified or shown on drawings metal ties in cavity walls/brick facing shall be spaced in a staggered manner with a minimum spacing of 3 feet horizontally and 18 inches vertically.

8.3.9 Anchors

Install reinforcing bars anchors projecting into the masonry a minimum of 6" and into the facing brick a minimum of 3" bars during the construction at 18" centres vertically and 36" horizontally.

8.4 BRICK WORK IN ARCHES

All the bricks used in arches must be selected carefully. The joints of all the bricks in each course shall be laid radially and bricks shall be cut to ensure uniformity in the width of the joints.

8.4.1 Workmanship

Arches shall be constructed true to radius on rigid centering with 1/8" variation permitted.

The centering shall be accurately constructed of wood preferably, or metal, depending on the radius of the arch. However, if masonry centering is used, the top shall be covered with building paper to permit masonry to move as the mortar shrinks.

8.4.2 Method of Construction

Arches shall be constructed in segments day by day as required by construction drawings. Brickwork adjoining the arches shall be built level with the arch construction, so that the arch is not under load at any stage of construction.

Where arches are reinforced, the grout shall be poured in stages as each segment is built. Grout must be kept clean of loose mortar, and of mortar projections at all times.

The construction of inverted arches if required shall require special effort to ensure that the stretcher bricks are cut to a true radius in order to provide a proper bed for the arch. The following procedure may be followed: -

- a) Erect a wood frame, flush with the outer face of a wall, upon which the radius centre may be marked.
- b) Nail a radius rod to this point, which has been marked as extrados and intrados of the arch with allowance for 1/2" mortar joints.
- c) As the work progresses up, the bricks intersecting the line of the extrados should be laid temporarily in position, marked and accurately cut to fit the radius.
- d) After laying about eight courses of brick in this manner the arch itself may be started using the radius rod to check the real points and the curve.

8.4.3 Cut Brick Work

Bricks shall be cut dressed or grooved as required or shown on the drawings. No extra payment shall be made for such work.

8.4.4 Bed Plates of Concrete

Bedplates of cement concrete Class-C shall be provided under each beam or joints. They shall conform to the dimensions given in the drawings. The payments of bedplates will be made as per relevant BOQ item of cement concrete Class-C.

8.5 CURING

The brickwork laid in cement mortar shall be water cured by keeping it wet for at least 10 days.

8.6 PROTECTION

All brickwork shall be protected during construction from the effect of rain and frost or any natural forces. The Contractor at his own cost without any extra payment whatsoever shall make if the work already carried out gets damaged well.

8.7 SCAFFOLDING

Necessary and suitable scaffolding shall be provided to facilitate Construction of brick wall in superstructure. Scaffolding shall be sound and strong with supports and member sufficiently strong so as to withstand all loads likely to come upon them.

8.8 MEASUREMENT

Measurement and payment for brickwork will be made to the neat lines of the structures as shown on the Drawings or as modified for the appropriate items for which such brick work is incorporated. Deductions will be made for all openings for doors, windows, ventilators, gates etc.

.....End of Section.....

9.1 DESCRIPTION

The work covered under this Section of specifications consists of furnishing all labour materials and equipments and performing all operations in connection with the carrying out of the work of P.C.C. flooring, including all related items such as wearing surfaces, bases skirting etc., in strict accordance with the requirements of Drawings and schedule of floor finish and subject to the terms and conditions of the Contract Documents.

9.2 GENERAL

The Contractor shall strictly follow and adhere to written instructions as mentioned on drawings and specifications. Floor finishes shall be laid true to the line and level. Any work covered under this section of the specifications, not conforming to the requirements of the specified quality and workmanship will be rejected and the Contractor shall be required to remove and replace such work as directed at his own cost.

9.3 MATERIAL REQUIREMENTS

9.3.1 Cement sand coarse aggregate shall conform to the specification given in Section-I " Materials ".

9.3.2 Division Strips:

Division strips shall be 1-1/2" deep x 5mm thick plate glass or as specified, embedded and fixed with cement mortar in base concrete to a required depth, level, plumb, line, angle, panel, shape to meet the requirements.

9.3.3 BASE

The base shall be either dry brick ballast and sand or lean concrete Class-E or as specified in BOQ item and as shown on the drawings.

9.4 CONSTRUCTION REQUIREMENTS**9.4.1 Preparation of Base****Floor**

The surface of the base concrete shall be brushed with a stiff broom just before it hardens to remove all laitance and loose aggregate and at the same time to roughen the surface to improve the bond. The hardened base shall be thoroughly cleaned, wetted preferably over night, the surplus water removed and a grout of cement and water brushed into the surface just ahead of the application of the topping.

Dado/Skirting

The plaster on the portion of the wall to be provided with skirting or dado shall be left in a rough state by brooming or by using wire brushes of approved type so as to provide a bond between this base plaster and the dado or skirting. The surface of the wall shall be cleaned of all foreign matter and shall be thoroughly wetted to control the suction. Only so much mix shall be mixed with water that could be utilized within 30 minutes. This mix of cement sand shall be applied to the wall and trowelled hard to a smooth surface, proper in line both vertical and horizontal. Finishing for the cement sand skirting shall conform to specifications for plaster work " Section 16 ".

9.4.2 Panels

Before laying the cement concrete flooring, the surface of the base shall be divided into panels of required sizes as shown on drawings. Panels shall be made of glass screeds or as specified. The top of the screed shall conform to the specified level of the finished floor surface.

9.4.3 Mixing and Placing

Mixing and placing of concrete shall be in accordance with specification given under heading " Concrete Work"

Concrete may be conveyed in any suitable manner from the place of mixing provided there is no segregation or loss of any ingredients, and provided it is placed in its final position before initial setting takes place, that is within 30 minutes of addition of water to the mix.

The concrete will be laid in a manner so as not to cause the aggregate to separate from the mortar. The concrete shall be rammed and thoroughly consolidated until the mortar creams upto the surface.

The concrete will be laid in alternate panels, each panel not exceeding the area, as directed. Dividing Strips of glass as specified shall be provided wherever shown on drawings.

FINISHING

Immediately after consolidation, the surface shall be leveled with a wooden trowel.

- 9.5 Excessive trowelling in the early stage shall be avoided. The surface shall be tested with a straight edge to detect undulations, which, if found, shall be eliminated. The finer stuff in the concrete, which has come to the surface with the stroking, shall be quickly but carefully smoothed with the steel trowel. When the concrete has hardened sufficiently, trowelling shall be done with steel trowel. No dry cement or a mixture of dry cement with sand shall be sprinkled on the surface for hardening the surface.
- a]Concrete Floor (Smooth) with Topping

Colour topping shall consist of a pigment which shall be added to cement on trial basis till the required shade is obtained. Thickness of the colour topping shall be 1/8" thick.

An approved sample specimen of the topping of required shade shall be available at the site before proceeding with the entire work.

After approval of the trial specimen adequate quantity of the mixture of pigment and cement shall be prepared for sufficient work to avoid any variation in shade. After wooden trowelling of the base, topping shall be applied to the specified thickness and spread out evenly by a wooden float, after waiting for a few minutes to bring it to a little drier stage, steel trowelling shall be applied with pressure till a smooth finish is achieved.

b] Concrete Floor (Roughened)

After the floor surface has been leveled with a wooden trowel, and the concrete has hardened sufficiently it shall be roughened with expanded metal mesh, wire brush or a broom. A sheet of expanded metal mesh shall be pressed evenly on the concrete surface to achieve the required pattern. Rough surface using wire brush or broom shall be achieved by stroking the green concrete surface with smooth and even strokes as per the required pattern.

9.6 CURING

Curing shall be done as per specifications given under section "Portland Cement Concrete".

9.7 MEASUREMENT

The measurement for Cement Concrete floor shall be made in Sq.M/Sq.Ft. of the actual surfaces completed and approved. Cement sand skirting shall be measured in Lin.Ft./M.

.....End of Section.....

10.1 DESCRIPTION

The work included under this section shall comprise of providing and fixing marble tiles in floor at locations shown on the drawings. Unless otherwise specified all marble tile work shall be in conformity with the latest British Standard Code of Practice for this trade.

10.2 MATERIAL REQUIREMENTS

10.2.1 Marble: shall be compact, dense, metamorphic rock of lime stone origin from quarries in Pakistan. It shall have specific gravity of about 2.7 and density of 170 lbs. per Cft. It must be evenly grained with sugar like appearance when broken.

10.2.2 Size & Thickness

Generally marble tile shall be of size specified by the design consultant.

The type of marble has been indicated on the drawings and shall be as called for in the BOQ.

10.2.3 Mortar

a] The ratio of cement sand mortar for laying and embedding marble tile work shall be (1:3) or as given in the relevant item of BOQ and shall be of specified thickness as shown on drawings or directed by the Consultants In-charge.

b] Dry Bond Mortar

Dry Bond Floor wall thin set mortar shall be as manufactured by the approved manufacturer. The ratio of dry bond mortar shall be as per the manufacturers directions and as directed by the Consultants In-charge.

10.2.4 Portland cement

Portland Cement shall conform to B.S. # 12 and shall be that manufactured in Pakistan conforming to the specifications set-forth in Section-I " Materials ".

10.2.5 Aggregate: Fine aggregate shall conform to the specifications set-forth in Section-I " Materials ".

10.2.3 CONSTRUCTION REQUIREMENTS10.3.1 Samples and Tests

The Contractor shall produce samples of marble tiles to be used for this item of work for selection, testing and approval. The samples shall be in finished sizes and shapes and adequate in number for testing in the laboratory as and when ordered. The tests for marble shall be as per B. S. or ASTM Standards for the determination of :

Weight %age Absorption	ASTM	C-97-47
Modulus of Rupture	ASTM	C-99
Compressive Strength	ASTM	C-170
Resistance to Abrasion	ASTM	C-241-51
Flexural Strength	ASTM	C-880-78

The Contractor may also be required to produce samples of finished item of marble work fixed in position before he is allowed to proceed with the work on a particular item.

10.3.2 Workmanship.

The Contractor shall employ skilled and trained marble workers for doing this job. He may be allowed to employ an approved specialist Sub-Contractor for this item of work. The surface over which the marble tiles are required to be fixed will be clean of all dirt and dust and should be properly hacked so that the mortar sticks well to the surface. The edge of the marble tiles shall be dressed true and square by rubbing them with carborundum stone or any other approved means and the same will be fixed in position.

The marble tiles on wall shall be laid in 3/8" thick dry bond mortar over a 3/4" layer of cement sand mortar (1:3) as shown on the drawings. Marble tile shall be allowed to season for at least three days during which it shall be kept moist.

Tight joints for marble, work should not exceed 1/8" and should be filled with white or coloured cement mortar as specified on drawings to match the marble.

Due allowance shall be made for movement of the structure and backing by including construction and expansion joints in the marble work. These shall be properly filled with approved mastic compound. Expansion joints shall be formed to coincide with the expansion joints in the building.

10.3.3 Final Finish.

The Contractor shall make suitable arrangement for giving final finish to the marble tile works such as cleaning, washing and polishing as specified.

The marble shall be polish finished to a glossy surface that will reflect light to emphasize the colour and marking, produced by a buffer with putty powder applied to a honed surface. All finished surfaces shall be of uniform texture, colour and appearance and shall be within the sample approved. Allowance shall be made for exerting of all necessary controls, batching or other methods to ensure uniformity in quality of stone within acceptable limits.

10.3.4 Protection and Maintenance

The Contractor against any damage thereof shall protect the completed works or parts. The works shall be handed over in perfect condition. If any damage is incurred then the Contractor shall remove and/or replace the same at no additional costs. The Contractor shall exercise all care to protect the works executed by other trades and not covered by his Contract. Any damage to these shall be made good and the works restored at no additional cost.

10.4 MEASUREMENT

The marble tile work under this Section shall be measured and paid for as quoted against the respective item of work in the Bill of Quantities. Measurement shall be made in sq.ft/m of the actual surfaces completed and approved.

.....End of Section.....

11.1 DESCRIPTION

The work covered under this section comprises of providing and laying best quality local made glazed/matt Granit/Porcelain/ceramic tiles of approved size and pattern wherever required or shown on the drawings or mentioned in the Bill of Quantities.

11.2 MATERIAL REQUIREMENTS

Except as otherwise specified the following British Standards and Code of Practice shall be applicable to materials and fixing methods for ceramic tile work:-

- a] British Standard 1281:1966 " Glazed Ceramic Tiles and Tile. Fittings for internal wall ".
- b] British Standard C.P. 212: for fixing methods and workmanship.

11.2.1 Joint Filling

Joint Filler shall be white Portland Cement grout which shall bond to dry tile, shall be non-shrinking, stain resistant, permanent in colour, and shall not inhabit fungus and bacterial growth. It shall be odorless and non-toxic, of smooth consistency for easy preparation and neat, rapid installation, and shall contain non- metallic material. Grout shall be water resistant and shall not wash out under water.

11.2.2 Adhesives

Adhesives for ceramic tiling as specified in the British Code of Practice C.P. 212 or Dry Bond Floor and wall thin set mortar as manufactured by Shabbir Tile and Ceramics Limited or equivalent approved.

11.2.3 Samples and Tests

The samples shall be furnished in sizes and colours and adequate in number for testing in an approved laboratory.

11.4 WORKING DRAWINGS

The Contractor shall prepare working drawings on the basis of working drawings for all the ceramic tile work to be carried out. These drawings will show clearly the sizes, method of fixing, jointing and the anchorage to be used in the process and the Contractor shall get approval in writing well in time before the actual start of the work.

11.5 CONSTRUCTION REQUIREMENTS

- a] In Cement Sand Mortar

Surfaces to receive the ceramic tiling shall be clean and free of dirt, dust, oil, grease or other objectionable matter. Setting beds and tile shall be installed with their respective surfaces to true planes, level or pitched to off-sets as required by the drawings, so that the surface of the completed tiling work will be at the elevations and grades shown. Re-tempering of mortar will not be permitted. Tiles shall be laid out from the centre lines of each space outward and adjustments made along walls, partitions and borders, if any, so as to symmetries the pattern with a minimum of cut tiles.

Joint between tiles shall be of uniform width and the same as the tile installed. Fractional changes in dimensions without varying the uniformity of joint widths

shall be permitted. Tile shall be cut with a suitable cutting tool and rough edges shall be rubbed smooth. Cut-tile misfits shall be laid to the straight edges. Straight edges shall be accurately set to the lines established and reset at suitable intervals to keep the joints parallel over the entire area.

Over the existing bed a topping of 1-1/2" thick PCC 1:2:4 shall be laid. Scratch coats for application as foundation coats shall be not less than 5/8" thick and shall be composed by volume of 1 part Grey Portland Cement to 3 parts dry sand, mixed with the minimum amount of water necessary to produce a workable mass. Mortar for scratch coats shall be used within one hour after mixing and re-tempering will not be permitted. Scratch coats shall be applied in sufficient quantity and with sufficient pressure to cover the entire area and to form good keys, shall be deeply scoured or scratched and cross-scratched, shall be protected and kept moist during the curing period. Scratch coats shall be thoroughly damp-cured, and an interval of not less than 24 nor more than 48 hours shall be permitted between application of scratch coats and application of float coats.

Float coats shall be composed by volume of 1 part Grey Portland cement to 2 parts dry sand, mixed with a minimum amount of water necessary to produce a workable mass. Float coats shall be applied in sufficient quantity to entire area and to form a good key, shall be brought out flush with the temporary screeds or guide strips so placed as to give a true even surface at the proper distance from the finish suitable for reception of tiles.

Joints shall be straight, level perpendicular and of even width throughout. Vertical joints shall be maintained plumb for the entire height of the tile work. Each tile shall be brought to true level and plane by uniformly applied pressure under a straight edge or rubber faced block. Tiles that are out of true plane or misplaced shall be removed and reset. Damaged or defective tile shall be replaced. The tile shall be installed as follows:-

Wall tile shall be set by troweling a skim coat of neat Portland Cement on the float coat or by applying a skim coat to the back of each tile unit and immediately floating the tile into place. After tile has set remove mortar using a minimum of water. Replace damage tiles.

After the tiles have been thoroughly set, joints shall be grouted full with a plastic mix of neat, white cement immediately after a suitable area of tile has been set. The joints shall be struck flush and excess mortar shall be cut off and wiped from the mortar joints after grout has been cleaned from the surface shall be roughened at once and filled flush with the tile edge, before the mortar begins to harden. Tile skirting and coves shall be solidly backed with mortar.

b] In Thin Set Mortar

Tiles laid in Thin Set Mortar shall be applied as per details shown on drawings and shall consist of a P.C.C. base of specified thickness. Tiles shall be set by troweling a skin coat of Dry Bond Mortar on the base coat and combed with a notched edge of trowel. Back butter each tile unit to ensure 100% mortar coverage and float the tile into place, tapping the tile to ensure maximum bond strength. All other installation requirements shall be as per specifications mentioned above.

11.6 MEASUREMENT

The measurement shall be made in Sq.Ft./Sq. M. of the actual surfaces completed and approved.

.....End of Section

12.1 DESCRIPTION

The work covered under this section of Specifications consists of furnishing all labour and materials and performing all operations in connection with installation of all wood work, mill work, construction, assembly and surface finish treatment, building in of all cabinet type of items, complete in every respect, including all related items, supports etc. of wood or metal and incidentals, associated wood work appurtenances, the application of all 'Hardware' in connection with finished wood work, in strict accordance with requirements of Drawings, as specified herein subject to the terms and conditions of the Contract Documents. The work under this section shall further conform to the requirements of the British Standard Codes of Practice, e.g. Cp. 151:Part 11:1957, CP.112.100: 1952 and all the British Standards relied therein and/or bearing relevance to this item of work.

12.2 MATERIALS12.2.1 Timber

Materials for the work included in this section shall conform to the following:

i) General Characteristics

The timber shall be in accordance with the requirements of BS:1186 'Quantity of Timber and Workman ship in Joinery', Part 1, 'Quality of Timber'.

First quality timber shall be from the heart of a sound tree, the sap wood being entirely removed, the wood being uniform in substance, straight in fiber, free from large or dead knots, flaws, shakes or blemishes of any kind. The colour of good timber shall be uniform through out and among coloured timbers; darkness of colour is an apparent indication of strength and durability.

For first quality teak wood, the size of the knot shall not be more than 1/2" and there should not be more than one knot in every 9 Sft. of timber.

For first quality deodar wood, the size of the knot shall not be more than 1" and there shall not be more than one knot in every 4 Sft. of timber.

ii) Seasoning of Timber

Timber shall be properly seasoned. It shall be kiln or air dried to reduce the moisture content to a minimum of 20% of its natural weight.

The methods of seasoning timber are as follows:

a) Air Seasoning

This consists of sawing the logs into planks or rectangular sections of convenient size for use and stacking them in such a way that air can circulate around the wood, preferably in open sided sheds. The moisture contents will be reduced to about 15%. The time depends on the type of wood, its thickness and the weather. Generally, soft wood takes 2 to 3 months and hard wood about 8 to 12 months for every inch thickness.

b) Kiln Seasoning

This process consists of drying the wood in a kiln. The process consists of fanning a blend of warm dry air and warm moist air over the wood at a controlled humidity. Kiln drying is preferable for internal joinery and furniture as air seasoning does not

reduce the moisture contents sufficiently to ensure a stable equilibrium. Time taken to kiln-dry hard woods varies from a few days in the case of thinner boards upto 3 to 4 weeks for 3 inch planks.

iii) Preservation of Timber

Preservatives may be applied in a variety of ways including pressure impregnation, hot and cold open-tank treatment, sleeping, dipping, brushing and spraying depending upon the use of timber and class of the preservative treatment according to the British Standard Code of Practice CP:98:1964. Local proprietary products of chemical wood preservatives under the label of "WOOD GUARD" or equivalent shall be used along-with their implied methods of use etc.

iv) Timber Quality

The requirements set forth in BS: 1186, Part 1, shall serve as a general guide in selecting timber including plywood of suitable quality.

v) Adhesives

For joiners work animal glues complying with BS: 745, 'Animal Glues for Wood' casein glues complying with BS:745, 'Cold Setting Casein Glue for Wood', or synthetic resin adhesive complying with BS:1204, 'Cold Setting Synthetic Resin Adhesives for Construction Work in Wood' shall be used. For flush doors and other forms of construction that rely mainly upon the adhesive, and particularly where exposure conditions are severe and prolonged dampness is likely to occur, one of the more moisture resistant shall be employed, the choice depending upon the severity of the conditions to which the work will be exposed.

vi) Nails and Screws

For joiners work, wire nails oval, chequered head, lost head round or panel-pins complying, with BS: 1202, 'Wire Nails and Cut Nails for Building Purposes' or wood screws in accordance with BS: 1210 shall be used. The gauge of nail or screw used shall be suited to the woods being fixed and to which a fixing is being made, and the length shall be such as will give a sufficiently strong and secure fixing. CP: 112. 'The Structural Use of Timber in Buildings' shall be followed which gives relation ship between gauge, amount of penetration and strength. All nails and screws used with reactive timber (becoming stained and disfigured by reaction with ferrous metals) shall be of non-ferrous metals or shall be protected in some manner before use if the wood work is likely to be subjected to moist conditions, e.g. external doors.

12.3 Ply Wood

BS: 565:1963 Section 5, 'Glossary of Terms Applicable to Ply Wood', defines plywood as 'an assembled product made up of plies and adhesives, the chief characteristic being the crossed plies which distribute the longitudinal wood strength'. The term ply wood in general sense includes similar products such as laminated board, block board and batten board. BS:1455:1963 shall be used for acceptable standards of ply wood.

i) Three Ply and Multiple Ply Wood

Three-ply construction includes a 'face' a 'back' and a core or inner ply. Multiply includes a face, a back and a core of three or more inner plies. With very few exceptions the grain of each veneer in the core runs at right angles to that of the veneers on either side of it.

The construction of plywood may be balanced with an odd number of veneers arranged symmetrically or unbalanced. The tendency of the finished board to distort is reduced by adopting a balanced construction.

The construction may vary for a given panel thickness by the inclusion of veneers of various thickness. This will affect the strength properties.

Ply wood according to BS: 1455:1963 is classified into two main types, viz interior and resin bonded.

Interior type ply wood is suitable for most interior work including flush doors, door panels wall paneling, balustrades, sub-flooring, kitchen fittings, and any location where resistance to moisture is not required. Adhesive used include casein, Soya, blood albumen and animal glues as well as synthetic resin extended with other substances.

Synthetic resin bonded ply wood while being suitable for the same purpose as interior type, has a much greater resistance to moisture. The more resistant types are suitable for external flush doors and door panels, wall sheathing, shop front fascias, sign boards, shuttering and form work for concrete and for any purpose where it may be exposed to moisture. Adhesives used include urea, melamine phenol and resorcinol formaldehyde (arranged in order of increasing moisture resistance).

The CONTRACTOR shall procure ply wood according to various grades specified in BS:1455:1963 "Ply Wood Manufactured from Tropical Hard Woods" and are briefly given as under for guidance.

Grade 1 Veneer: Shall be of one or two pieces of firm smoothly cut veneer. When of two pieces, the joint shall be approximately at the centre of the board. The veneers shall be free from knots, worm and beetle holes, splits, dots, glue-stains, filling or inlaying of any kind or other defects. No end joints are permissible.

Grade 11 Veneer: Shall present a solid surface free from open defects. Veneers, when jointed need not necessarily be matched for colour or be of equal width. A few sound knots are permitted with occasional minor discoloration and slight glue stains, isolated pinholes not along the plane of the veneer. Occasional splits not wider than 1/32 inch and not longer than 1/10 of the length of the panel or slightly opened joints may be filled with suitable filler. No end joints are permissible.

Grade 111 Veneer: May include wood defects including work holes which are excluded from Grade 1 and 11 above in number and sized which will not impair the serviceability of the ply wood. It may also include manufacturing defects such as rough cutting, overlaps, gaps or splits provided these do not affect the use of the ply wood. No end joints are permitted.

The uses, for which ply wood made with the grades defined above are considered useful, are outlined hereunder:

Grade 1 For use in its natural state.

Grade 11 For use where subsequent painting and / or veneering is intended.

Grade 111 For use where it is not normally visible.

Under the Specifications where combinations of above grade are required, these

combined grades may range from 1/11, 11/11 and 11/111, as additional grades of these Specifications.

ii) Laminated Board

This is built-up board, with narrow strip 3 to 7 mm wide, faced both sides with either one or two veneers from 1.2 mm to 3.7 mm thick. Where single or double face veneers are used, the grain usually runs at right angles to the grain of the core strip. This type of board when available varies between 1/2 inch to 1 inch and is an ideal base for the highest class of veneered wood. For detailed Specifications, BS:3444:1961, 'Block Board and Laminated Board' shall be used.

iii) Block Board

This board is of similar construction to laminated board but core is built-up of blocks upto 1 inch wide. It is used as a base for veneering and for painted work but is considered slightly inferior to laminated board for the former use. The range of size and thick-nesses in which it is manufactured are similar to those of laminated board. For detailed Specifications BS:3444:1961, 'Block Board and Laminated Board' shall be used.

iv) Fabrication

Ply wood can be worked by all normal wood working tools, both hand and machine and can be fixed by panel pins, screws, rivets, gluing, grooving, into framing, tonguing and grooving and by metal tooth plate or split ring connectors. For exterior work, galvanized and copper nails and also water-proof adhesives shall be used.

12.4 Boards

The proprietary boards are known as fibre building boards and chip boards or particle boards. The fibre boards include hard boards insulation boards and straw boards. These boards follow the description in the following order:

i) Fibre Building Boards

Fibre building boards form the largest category with the number of different types as detailed hereunder:

a) Hard Board

Density from 30 to 50 lbs per cft. There are three main sub-divisions, being medium (30-50) lbs per cft.) standard medium (50 lbs per cft.) tempered hard board/standard hard board treated to increase hardness and resistance to water.

b) Insulation Board

Maximum density 25 lbs per cft. minimum thickness 7/16 inch, maximum thermal conductivity (K) 0.45. They have five sub-divisions, viz homogeneous, laminated bitumen bonded, bitumen impregnated, acoustic (of low density and specially designed often with perforated surface to increase sound absorption). These boards have good qualities of thermal insulation and sound absorption and are of qualities of thermal insulation and sound absorption and are recommended accordingly.

c) Straw Boards

These are compressed straw slabs, consisting of straw formed into slabs 2 inches thick by heat and pressure and with proprietary paper glued to the sides. Edges too are bound with paper. The slabs are fairly stiff and have thermal conductivity (K) of 0.6.

ii) Wood - Chip Board (Particle Board)

Chip boards are made from wood particles in the form of chips or shavings of a controlled size combined with a thermosetting synthetic resin glue binder and formed into panels under the influence of mechanical pressure and heat. The process of adhesion is controlled resulting in a variety of boards with different, but predictable physical proper ties. Chip board lends itself well to uses such as sheathing, flooring and sub-flooring, wall

paneling, partitions, shelves, furniture and veneered boards, core stock. It is little affected dimensionally by changes in atmospheric humidity, but in wet conditions it has a limited resistance to moisture.

The mechanical strength properties are good for high density boards. In the density range 30.55 lbs/cft typical value of the modulus of rupture lies between 1500 to 3000 lbs/sq. inch. An average value for the modulus of elasticity is 300,000 lbs/sq. inch.

The surface finish of standard boards is comparatively rough and to support a good quality paint or varnish finish requires sanding and filling. Special grade of the board are prepared for painting which have a paper surface permanently bonded to the board during manufacture.

Particle boards are made in grades of high, medium and low density but the bulk production has been of medium density mainly in thickness of 1/2" and 3/4". These Specifications rely on BS:2504:1963, 'Medium Density Resin Bonded Wood Chip Board' for quality of the board and requirements for density, strength and other properties. The density range of this board is from 30 lbs/cft to 50 lbs cft and thermal conductivity is of the order of 0.7 to 1.0 B.T.U. in/ft. 2/h °F, BS:18111961 will be relied upon for testing of the wood chip board.

12.5 CARPENTRY WORK

12.5.1 General

All work specified in the Bill of Quantities and shown on working Drawings and details is to be carried out in proper manner. The CONTRACTOR has to provide all loose planks, battens, trestles and ladders and to construct all scaffolding necessary for the proper execution of the work and to remove the same on completion.

12.5.2 Preservative Treatment

Where preservative treatment is specified, the timber is to be of the correct moisture content and free from surface moisture and dirt. In general, all portions of timber built into or against or close to masonry or concrete, and all junctions or rafters, purlins, framing scribe pieces and wall plates etc. shall be given two coats of hot solignum, creosote or other wood preservative or as approved. Preservative material shall be applied in strict accordance with recommendations of the preservative manufacturer and shall be given to all wood work which comes in contact with or built into any wall, floor, ceiling or any other structure. All rough wood work which is not the finished and exposed wood work whether abutting any structure or not shall be given a preservative treatment. No extra payment shall be made for such coating and will be considered inclusive in the rate of the respective item quoted by the Contract. Treatment is to be carried out after all cutting and shaping is completed and care is to be taken to avoid damage. A liberal application of preservatives is to be made to cut or damaged surface, CP 112:100:1952, 'Preservative Treatment for Timber used in Buildings' shall be relied upon regarding preservatives and methods in relation to uses of timber.

12.5.3 Moisture Content

The timber prior to preservative treatment is to be properly seasoned. Timber fit for carpentry is considered seasoned when it loses 1/5 of its weight and fit for joinery when about 1/3 of its weight has been lost after felling.

12.5.4 Workmanship and Construction

'Unwrought' timber shall be 'left from the saw', and shall be full to the dimensions stated except that occasional slight variation in sawing is permissible.

All framing shall be jointed as specified and/or as determined as most appropriate in the

circumstances. The joints shall be as per standard practice depicted through architectural details and constructed so that load and stresses to which they will be subjected are properly transmitted.

Unless otherwise stated all joints shall be secured with a suitable type and sufficient number of nails. A butt joint shall, wherever possible, be secured with nails driven from the far side of the flanking member, if any. The joining surfaces of all connections exposed to the weather shall be thickly primed except where adhesives are specified. Where joints are designed in critical relation to loads, the size, spacing, type, positioning and number of nails, wood screws, bolts, the CONTRACTOR true to design details shall provide washers and timber connectors.

12.5.5 Procedure

The operations shall be planned and coordinated keeping in view the requirements and convenience of all tradesman concerned in the work.

The CONTRACTOR shall order materials for sizes and quantities as required to complete the job as per working Drawings and details. All work is to be set out and constructed to the dimensions given and as described on the Drawings and details.

12.5.6 Protection of Materials

All materials and assembled units shall be protected from the weather and stored in such a way as to prevent attack by fungus, decay and/or insect.

12.5.7 Inspection

Facilities shall be provided to inspect all work in progress in the work shops and on Site. All work under this section should be first Approved before being fixed in the building.

12.6 JOINERY WORK

12.6.1 General

All work specified in the Bill of Quantities and shown on working Drawings and details shall be carried out in proper manner. The CONTRACTOR shall manufacture, deliver to Site and fix in place all joinery including supply and fixing of metal, straps, lugs and dowels, priming, preservatives, polishing and all hardware specified and/or shown on the Drawings. Except where special finish is specified the joinery work shall be cleaned and scrubbed. The CONTRACTOR shall leave whole of his work in good order.

12.6.2 Preservative Treatment

Same as in C as above 14.5.2

12.6.3 Moisture Contents

Same as in C as above 14.5.3

12.6.4 Priming

Where priming is specified, the timber shall be coated with a thick mixture of red or white lead and linseed oil and priming shall comply with BS:2521:1954. The CONTRACTOR shall provide for priming and touching up primer where necessary during the progress of work.

Aluminum base primers may be used when timber is particularly resinous. Where synthetic paints are used, Manufacturers must be consulted on the type of primer.

12.6.5 Workmanship and Construction

All "Wrought" timber is to be swan, planed, drilled or otherwise machined or worked to the

correct sizes and shapes shown on the drawings and/or specified.

The arrangement of jointing and fixing of all joinery works shall be such that shrinkage in any part and in any direction shall not impair the strength and appearance of the finished work. Reasonable tolerance shall be provided at all connections between joinery works and the building carcass, whether of masonry or R.C.C. frame construction, so that any irregularities, settlements or other movements shall be adequately compensated.

The joiner shall perform all necessary mortising, tenoning, grooving, matching, tonguing, rebating and all other works necessary for correct jointing. He shall also provide all metal plates, screws, nails and other fixings that may be necessary for the proper execution of the joinery works specified. The joiner shall also carry out all works necessary for the proper construction of all framings, linings, hold-fasts and other contrivances as per architectural details for their adequate support and fixing in the building.

Loose joints are to be made where provision is required to be made for shrinkage or other movements acting in the direction other than that of the stresses because of loading. Glued joints are to be used where provision need not be made for shrinkage or other movements in the connection, and where sealed joints are required. All glued joints shall be cross-tongued or otherwise reinforced. All nails, springs etc. shall be punched and puttied. All cutting edges of tools shall be sharp to avoid burnishing.

All wood work, as far as practicable, shall be assembled in shop, finished and prime coated before delivery for fixing. In addition to machine sanding, all woodwork shall be smoothed by hand using "00" sand paper to obtain the required smooth surface, free from machine and tool marks, abrasions, raised grains and other undesirable defects. All wood work shall be fitted to plaster and other finished work in a careful manner so as not to injure these surfaces. Where plaster or other work is damaged or disturbed, it shall be restored to its original state by the CONTRACTOR at no additional cost.

All wood work shall be neatly finished to the exact dimensions specified. All nails and screws shall be of approved type. Hammer shall not be used for driving in or starting in the screws. All screws shall be dipped in oil before they are inserted in the wood. The heads of nails or screws shall be sunk and puttied or dealt with as directed.

The CONTRACTOR shall give at least 7 days notice in writing before any timber is to be covered in the ground or in walls or otherwise.

12.7 DOORS

12.7.1 Door Frames

Door Frames shall be fabricated of first class Deodar wood if specified according to design, sizes and sections shown in the Drawings. The wood shall be smoothly planed and all the joinery shall be perfect and strong.

The frames shall be secured to masonry or concrete with M.S. hold-fasts 9" to 3" long of type approved. These hold-fasts shall be screwed and not nailed to the frames. The hold-fasts shall be free of dust, scales, rust etc., and shall be painted with 2 coats of anti-corrosive paint before they are secured to masonry or concrete. The hold fasts shall be cast in concrete work. The minimum number of hold-fasts used shall be (3x2) unless otherwise specified.

12.7.2 Flush Doors

The Flush doors shall be obtained from approved manufacturers and shall be of the quality and kind as per these Specifications and of dimensions as shown on Architectural Drawings and shall comply to the requirement of Pakistan Standard No.142 of 1961.

Flush doors shall be constructed of plywood as specified earlier. It shall be synthetic resin bounded ply wood suitable for both internal and external flush doors and shall be of the

grades 1 and 11 as specified earlier. The facing shall be teak or commercial ply as specified.

The core shall be made up of solid laminated wood or as specified and shown on drawings. It shall have 3" wide solid wood edge rail of deodar wood all around and lock block of minimum 10" wide. The shutter shall be lipped and edged all around with hard wood. The core shall be chemically treated to be ant termite without affecting the inherent qualities of the core material and shall be fabricated with the grain running parallel to the grain of face veneer. Core material shall be accurately machined on all sides to ensure tight fitting core, free of voids throughout the core assembly.

The adhesives used in the door manufacture shall be special urea-resin type (liquid or powder), unaffected by oil, gasoline, solvents, resistant to the growth of fungus and bacteria, immune from insects and shall be such as to remain unaffected by paint and lacquer solvents. It should weigh approximately 10 lbs. per gallon when mixed for use having approximately 60% of solids content.

12.7.3 Fitting, Hanging and Trimming

Doors shall be fitted, hung and trimmed as indicated on the Drawings. Hinges shall be counter sunk into the door frames as well as leafs. The recesses being cut to the exact size and depth of the hinge. No subsequent packing shall be allowed. Brass screws shall be used with brass fittings unless otherwise specified. Hard ware shall be fixed as specified in the drawings. Locks and other hardware items shall be fixed at heights as shown on the Drawings or as directed.

12.8 HARDWARE

Items of hardware specified in the Drawings shall be carefully fitted and securely attached on completion of the work. Hardware shall be demonstrated to work freely, keys shall be fitted into their respective locks, and upon acceptance of the work, keys shall be tagged and delivered in duplicate. No separate payment shall be made for hardware fittings and fixture.

12.9 MADE GOOD DEFECTIVE WORK

Should any shrinkage or warping occur or any other defects appear in the joiner's work, such defective work shall be taken down and replaced. and any other work disturbed shall be made good at the CONTRACTOR's expense.

12.10 SAMPLES

The CONTRACTOR shall furnish 2 samples free of cost for approval of each fitting to be used prior to its use.

12.11 MEASUREMENT

The measurement shall be made in Sq.Ft/m of the actual surfaces completed and approved.

.....End of Section.....

13.1 DESCRIPTION

The work included in this Section shall comprise of providing, supplying, laying, fixing in position pre-cast Mosaic tiles it also includes furnishing all labour and materials and performing all operations in connection with the execution of flooring activity surface finish, curing, cutting, rubbing, polishing (chemical) of the following kinds wherever shown on the drawings and/or mentioned in the Bill of Quantities or directed by the Consultants In-charge.

13.2 GENERAL

The pre cast mosaic tiles shall be machine pressed tiles made of class-C concrete (3000 psi) using aggregate of fine size with terrazzo finish of the pattern, shade and thickness as specified in the bill of Quantities, drawings or as directed by the Consultants In-charge. The size of tiles shall be as specified in the BOQ.

These tiles shall be manufactured under special order by approved manufacturer. The contractor shall produce samples of the tiles for approval and reference / comparison at the time of mass production and laying in position.

The first two grinding of the tiles shall be done in the factory by machines and the final grinding and polishing shall be carried out after laying in position.

13.3 CONSTRUCTION REQUIREMENTS

The tiles will be laid to the required line, levels and grades over a setting bed of C.C. comprising of 1:2: 4 by volume. The thickness of C.C. shall be $\frac{3}{4}$ "-thick or as per B.O.Q. After seven days, the floors shall be machine ground true to an even surface using various grades of abrasive stones as required and directed by the Consultants In-charge.

After first grinding the floor shall be grouted with the same color/ composition as used for its manufacturer. The grout shall have the consistency of thick cream and shall be brushed over the floor to fill in the joints and after 72 hours, the grouting coat shall be removed by grinding till a smooth and even surface is obtained. Areas and portions of the floor inaccessible for the grinding machine shall be ground and rubbed by hand. The final gloss shall be given by polishing the surface as per BOQ and to the satisfaction of the Consultants In-charge.

13.4 MEASUREMENTS

The work for mosaic flooring shall be in sq. ft. floor area.

13.5 RATE AND PAYMENT

The rate of all items of work shall cover the cost of furnishing all material, labour, curing, grinding, polishing, finishing, and performing all operations at any height in accordance with drawings, BOQ and as specified BY THE Consultants In-charge. The rate shall include the cost of furnishing and installation for floors and installation for floor and providing all assistance to the satisfaction of the Consultants In-charge.

.....End of Section.....

14.1 DESCRIPTION

The work covered under this section of Specifications consist of furnishing all materials, labour and performing all operations in connection with plastering/rendering complete in every respect in accordance with the requirements of the Drawings and Specifications, and as directed.

The work carried under this section shall further conform to the requirements of the British Standard Codes of Practice CP:211:1966 and CP:221:1960 and all the British Standards and other Documents relied therein.

14.2 GENERAL

Except as may be otherwise shown or specified, all plaster shall be cement sand plaster. Plastered ceilings and walls shall include partitions, piers, columns, pilasters, plastered jambs and other returns, reveals and backs of recesses, alcoves, and jambs and heads of windows and doors, unless otherwise specified or shown on Drawings. Plaster on walls shall be carried down to Dado, Skirting and projection bases. Plaster work shall also include all plaster work on and under all concrete surfaces to be left exposed and concrete not required Fair Faced, until and unless specified otherwise. It would be the CONTRACTOR's responsibility to ensure that all electrical conduits, hidden or items to be embedded, ducts, pipes, brackets, doors, windows, ventilators and all other fixtures on walls, ceiling, columns or required elsewhere have been fixed in place before the plastering is started.

14.3 MATERIALS

14.3.1 Portland Cement shall be as described in section 5 "Portland Cement Concrete".

14.3.2 and shall comply with the requirements of ASTM designation C 35, British Standard 1199, Table 1.

14.3.3 Water shall be clean, free from harmful amounts of deleterious matter and from any unusual proportion of dissolved salts. Sea water, tidal estuary or brackish water shall not be used.

14.3.4 Metal lathing used as back ground for plastering should not weigh less than three (5) lbs/sq. yard for sanded plaster and (3) lbs/sq. yard for light weight gypsum plasters and shall comply with B.S. 1369 Metal Lathing (steel) for Plastering.

14.3.5 Galvanized wire netting where required to provide a mechanical key, 22 SWG galvanized wire netting of mesh not greater than 2" and complying with BS 1485, 'Galvanized Wire Netting' shall be used.

14.3.6 Barites: For Barium Sulphate plaster, barium sulphate fines shall be used.

14.4 PROPORTIONING OF PLASTER

14.4.1 All plaster shall be Portland Cement plaster, except otherwise specified and shall be mixed in the proportions by volume as indicated on Drawings.

Volume batching shall be done by proper gauge boxes and not by the shovelful.

14.4.2 Mixing

Plaster ingredients in the specified proportions shall be thoroughly mixed by Mechanical means.

14.4.3 All coats of plaster in liquid retaining structures shall be water-proofed by the addition of an Approved compound in liquid or solid form used at an Approved dose. The water-proofing compound shall be commercially pure with no oils or other ingredients which may be detrimental to the cement.

14.5 CARE OF TOOLS AND PLANT

14.5.1 All tools shall be cleaned by scrapping and washing at the end of each day's work, or between uses with different materials. Metal tools shall be cleaned and if necessary greased after each operation. All tools shall be examined and thoroughly cleaned before plastering is begun.

14.5.2 Gauge Boxes

Gauge boxes shall always be used for proportioning plaster mixes by volume and shall be kept clean.

14.5.3 Mechanical Mixers

Plaster mix shall be mixed for two or three minutes, after which the batch shall be discharged and not left in the mixer. When the mixer is not in continuous use, it shall be washed out after every mix as soon as the batch is discharged. When in continuous use the mixer shall be washed out about four times a day.

14.6 CLEANLINESS AND PROTECTION

Cleanliness is essential in carrying out plaster work. Adequate protection shall be given to all existing work and fittings which are liable to be damaged not only in the areas of plastering operations but in the approaches thereto by covering up with boards, dust sheets etc. as necessary. This is particularly important when mechanical methods of application are used.

On completion, all works affected by plastering operations shall be left clean. Special care will be taken when removing set plaster from glass to avoid damaging the surface.

14.8 BACK GROUNDS

14.8.1 Characteristics of the Back Ground

The back ground shall not have received any prior treatment such as painting or impregnation which is incompatible with adequate bond.

14.8.2 Preparation of Back Ground

Preparatory Treatment: The preparatory treatment as necessitated for the application of plastering systems shall be as per British Standard Code of Practice and/or as instructed.

14.8.3 Treatment of Mixed Back Ground

Where plastering is to be continued across back grounds of different classes, expanded metal shall be fixed across the junction to minimize cracking due to differential movements. Where small width of one material is involved e.g. concrete column dividing block panels, the column width shall be bridged completely by fixing expanded metal over building paper into the material abutting the concrete in order to isolate the plaster from any movement of the column.

14.10 WATER PROOF PLASTER FOR WATER RETAINING STRUCTURES

All surfaces continuously exposed to wet conditions shall be given water proofing treatment.

The water proofing treatment shall be done in plaster by using water proofing cement compound (PUDLO) especially made for such purpose. It shall be applied as plaster in two successive layers of 3/4" each on all linear surfaces. The plaster shall be made by mixing the water proofing compound in the cement sand mix of 1:3 by volume according to the Manufacturer's instructions. Water proofing compound shall be allowed in sealed containers only. Only approved water proofing compound shall be allowed for use. Minimum five (5) lbs of water proofing compound shall be used for each bag of cement in preparation of waterproof plaster. In water tank all corners, vertical as well as horizontal shall have triangular cant strips 6"x6" size in mortar 1:6. The surface to receive waterproofing treatment shall be made rough by hacking and chiseling the concrete lightly to give a rough surface for bonding. After the surface has been made rough, metal lath (diamond mesh) shall be nailed to the entire surface in an Approved manner. The first layer of water proofing plaster 3/4" thick shall then be applied and its surface shall be made rough by the use of a brush or other suitable instrument. The first layer shall be allowed to cure for a minimum of forty eight (48) hours before the second layer of water proofing plaster with metal lath as in first layer is applied. The second layer of plaster shall also be 3/4" thick and its surface shall be trowel finished by means of steel trowel to give a smooth and even surface from the inside. The plaster shall be cured for a minimum of fourteen (14) days after laying of second layer of water proofing plaster. Water proofing plaster work shall not be started until all pipes have been installed. Any damage or leak discovered in the tank shall be repaired by the CONTRACTOR at his own cost.

14.11 SAMPLING OF PLASTER

Samples may be taken at any time from plaster work in place for testing.

14.12 PATCHING

Plaster containing cracks, blisters, pits, checks, or discoloration will not be accepted. Such plaster shall be removed and replaced with plaster conforming to this Specification.

14.13 MEASUREMENT

All plaster work shall be measured and paid for the actual work executed paid for at the unit rates entered in the Bills of Quantities.

.....End of Section.....

15.1 DESCRIPTION

The work under this specifications consists of furnishing all labour, materials, equipment, incidentals and operations to complete all external surface rendering/coating work on Masonry, concrete or any other surface as specified in this Section. The work generally includes but is not necessarily limited to the following:

- i) Base coat of cement sand plaster (1:4) 1/2" thick, including grooves as specified.
- ii) Finish coat of natural marble chips (mesh 14-large wall coating 1/8" thick including a clear coat of water repellent sealant on top.

15.2 MATERIAL REQUIREMENTSPlaster Materials:

- a) Portland Cement: ordinary conforming to B.S.12.
- b) Fine Aggregate: shall be hard coarse sand, crushed stone or gravel screenings and shall conform to requirements of P.S. 243 and/or B.S. 882. Fine aggregate shall be clean and free from clay loam, silt and other deleterious material.
- c) Water: potable, clean and free from deleterious amounts of oils, salts, alkali organic matter and other harmful materials.

15.3 FINISH COAT MATERIALS

- a) Marble Chips Coating: The composition of this product shall consist of natural quartz pigments of high temperatures, acrylic resins in water emulsion anti bacteria and anti fungus additives.
- b) Water repellent clear Coat: shall be a product suitable for exterior/interior application. It shall protect the surface from the aggression of atmosphere agents. It should completely seal the exterior and should be water repellent and yet retain breathing capabilities to allow moisture to breathe through and evaporate. It shall also be resistant to sunlight, ultraviolet radiation, violent impacts, fungus salt and mildew.

15.4 SUBMITTALS

Samples: Submit two (2) 12"x12" size samples of wall coating for approval. All subsequent work shall conform to the approved samples. Colour of the approved samples shall be the colour standard by which all work will be compared.

15.5 SUPPLY AND STORAGE OF MATERIALS

15.5.1 Cement: shall be stored in weather tight sheds/stores which will provide protection from dampness and contamination cement shall be delivered in unopened bags plainly branded with the manufacturers name. It shall be stored in such a way that each consignment shall be used in the same order as that of receipt on site. Any cement damaged by water or otherwise defective, must be removed from the site immediately.

15.5.2 Fine Aggregate: The supply of fine aggregate shall be drawn only from the approved source. The aggregate shall be determined and stored adequately at site. It shall not be stored on muddy

ground or where it is likely to become dirty or contaminated, precautions shall be taken to avoid pollution by undesirable surrounding material and earth.

- 15.5.3 Wall Coating: Deliver materials in manufacturer's original un-opened packages or containers with labels intact and legible indicating brand name and contents. Store materials off the ground, under cover, protected from dampness or wetting. Remove items delivered in broken, damaged, rusted or un-labelled condition from project site, immediately, Remove wet or deteriorated material from the project site.

15.6 CONSTRUCTION REQUIREMENTS

Plastering of Base Coat

- 15.6.1 Preparation of Concrete Surfaces to be Plastered:

Concrete surface to be plastered shall be cleaned to remove all grease, form oil and other surface impurities which will otherwise adversely affect the adhesion of plaster to the surface concerned. The concrete surface shall be lightly hacked by approved means to give the required key for plastering. Not less than 40% of the surface shall be roughened to approval.

- 15.6.2 Preparation of Block/Brick Masonry and Surfaces to be Plastered

All surfaces to be plastered shall be cleaned to remove all matter which will otherwise adversely affect the adhesion of plaster to the surfaces. All block/brick surfaces shall be well wetted before the application of plaster.

- 15.6.3 Preparation of Cement Mortar for Plaster:

All the ingredients for plastering shall be proportioned by volume in containers of known capacity to maintain consistent proportion.

No lumpy or caked material shall be used. Mechanical mixers, mixing boxes, platforms and tools shall be cleaned before and after mixing the required number of batches. Materials shall be proportioned as specified in the Bill of Quantities.

Plaster ingredients shall be thoroughly mixed either by hand on a clean cement concrete platform or by mechanical mixers as directed. Mixing shall be continuous until uniformity in colour and consistency is obtained.

Only limited water shall be added for proper workability and such quantity of the mortar shall be prepared as that which will be consumed in thirty minutes after preparation. Preparation of mortar in bulk quantity for use during the entire day or for any other time more than that stipulated above is prohibited. Re-tempering shall not be permitted and all mortar which has begun to stiffen shall be discarded.

- 15.6.4 Application of Base Plaster:

The surface on which plaster is to be applied shall in case of Brick/Block Masonry be properly raked and wetted before application of plaster. It shall be applied in a thickness of 1/2" and shall be carried out to the full length of the wall or to the natural points. Vertical or horizontal grooves shall be provided as shown on drawings or as specified. The base coat shall be water cured for at least 7 days or as approved before the application of the final marble chip coating. Defective plastering if any shall be cut out and re-plastered at the expense of the Contractor.

15.7 MARBLE CHIP WALL COATING

15.7.1 General

Before beginning "Marble Chip" coating the contractor shall ascertain that all electrical, plumbing, built in items, door and windows frames and all other apparatus and appurtenances are fixed in final position. The Contractor shall rectify any deficiencies before the coating can begin.

15.7.2 Quality Assurance

Allowable tolerances of completed wall coating. Maximum deviation from a true plane shall be 1/32", as measured from the line of a 10 feet straight edge placed at any location on the surface.

15.7.3 Mixing

The coating shall be readily mixed to a uniform consistency and the presence of an aggregate shall be apparent but there shall be no sign of caking, granulation or hardening of the material in the container.

15.7.4 Application of Wall Coating

It shall be applied to the cured and smooth surface of the base coat in the thickness not less than 2mm thick or as recommended by the manufacturer and approved. Grooves shall be provided as required and specified. The marble chip coating shall be trowled to a true even surface free from cratering, bubbles or pin holes in the dry film. The finish coat shall conform in appearance to approved samples.

15.7.5 Patching

Point up around trim and other work. Cut out and patch defective and damaged work. Patching of marble chip coating shall match existing work in texture and finish and shall finish flush and smooth with coating previously applied.

15.7.6 Water Repellent Clear Coat

Application of the clear coat shall be done in temperatures between + 5 degree centigrade and 55 degree centigrade (41 degree F and 131 degree F) with a relative humidity not exceeding 87%. Application shall be protected from direct rain fall, smoke or dust. All surfaces shall be compact and seasoned and free of dirt and oil stains. Application shall be done by compressed spray to give a uniform finish.

15.7.7 Cleaning Up

Remove protective materials and any "Marble Chip" coating from adjacent surfaces".

15.7.8 GUARANTEE

The finished marble chip coating shall be guaranteed for a period of 10 years from the date of final acceptance. Coating that does not meet the requirements during the 10 years guarantee period shall be removed and replaced at no additional cost.

15.9 MEASUREMENT

The Measurements of items covered under these specifications shall be made in Sq.Ft/M. of the actual surfaces completed and approved. Deductions will be made for all openings for doors windows, ventilators etc.

.....End of Section.....

16.1 DESCRIPTION

The work covered under this section of Specifications comprises furnishing of all labour, plant, equipment, appliances and materials and performing all operations in carrying out and in connection with the furnishing and fixing of aluminium extruded metal cover assembly, retainer clips and metal covers over floors, vertical and roof expansion joints and all related items such as fastenings, bolts, etc. and other items supplied and customarily built-in and/or installed in strict accordance with the drawings, specifications and instructions.

16.2 MATERIAL REQUIREMENTS**16.2.1 Aluminium**

All Aluminium extrusions shall be heat treated aluminium alloy conforming to B.S. 1474 : 1972 H.E.9.

16.2.2 Filler Material

Pre-molded expansion joint filler shall be of an approved manufacturer and should conform to the requirements of the B.S. or ASTM standards.

16.3 CONSTRUCTION REQUIREMENTS

Floor expansion joints at locations, where shown on the drawings shall be provided with extruded Aluminium sections on either side of the joints and the entire assembly covered with an extruded metal cover. The metal cover assembly shall conform to the dimensions and details shown on the drawings and shall be installed as shown. The extruded metal cover and retainer clips required at walls shall conform to the dimensions and shapes shown on the drawings and shall be attached to the wall with counter sunk head stainless steel machine screws spaced not more than 24" on center. The metal cover assembly at floors shall be attached to the floor with anchor bolts as shown on drawings. The free space on one side shall be filled with a compressible material of an approved manufacturer. The cover assembly shall be as manufactured by Krud Sons, ALCOP, or approved manufacturer. Flexible bitumastic type filler material shall be provided at all roof and wall joints and the joints sealed before applying metal cover over expansion joints and fixed with Steel Clips.

16.4 MEASUREMENT

Measurement will be made of the linear feet of expansion joint at all the floors, ceilings, walls etc. and wherever shown in the drawings. Measurement will be made of the Lin. Ft/M. of the joint cover over the expansion joint on the roof ceilings and walls provided in accordance with the drawings.

.....End of Section.....

SECTION - 17 ROOFING AND WATERPROOFING /ROOF INSULATION

17.1 DESCRIPTION

The work under these specifications consists of furnishing all labour, materials, equipment, incidentals and operations to complete all roofing activities for waterproofing and insulation of roof on Masonry, concrete or any other surface as specified in this Section in accordance with the relevant item of BOQ's and to the satisfaction of the Consultants In-charge. The work generally includes but is not necessarily limited to the following (unless otherwise specified, the roofing and waterproofing shall consist of) :

a) For Flat Roofs

Providing and laying of single layer of Hollow Kaghan roof tiles 9"x8"x3" of approved design grouted with cement sand mortar 1:3 laid over 2"- thick Chips screed comprising 1-part cement and 3-parts of marble chips 8 number finished smooth over 5 mm thick fabric based 0.5 mm thick aluminum foiled impregnated bituminous sheet over 2 coats of hot bitumen @ 25 lbs per 100 Sft. for each coat over R: C: C roof slab.

OR

Providing, laying, grouting and pointing 1st class burnt brick tiles 9"x4-1/2"x1-1/2" in 1:3 cement sand grout over (3") 76 mm (average) thick puddled earth laid to slopes and consolidated. The earth will be laid over water proofing, consisting of sand blinded coat of bitumen over R.C.C. roof, covered over with the one (1) layer of polythene sheet .008" thick over 2 coats of bitumen over R: C: C slab.

b) For Sloped Roofs, Vaults and Shades

Providing, laying, grouting and installing split tiles rough glazed of size indicated on the drawings, over 3/8" thick special Dry Bond Mortar over 1/2" thick Cement Sand base plaster (1:4) over RCC slab.

c) Over Drains

2-coats of VANDEX SUPER over drains on sloped roof.

17.2 MATERIAL REQUIREMENTS

17.2.1 Brick Tiles

Brick tiles shall conform to specifications of materials given in respective items of " Section-I Materials " and BOQ approved by the Consultants In-charge.

17.2.2 Split Tile and Special Dry Bond Mortar - shall conform to specifications given in the relevant Section and as shown on the drawings.

17.2.3 Mud Mortar

Puddled earth shall be composed of stiff clay to which an equal bulk of chopped rice husk/bhoosa shall be added.

17.2.4 Fabric Based Bitumatic Sheet (0.5mm-thick Aluminum Foiled)

As per manufacturer' specifications in accordance with the Relevant item of BOQ and approved by the Consultants In-charge.

17.2.5 Jumbolon

Two layers of Jumbolon if directed by the consultant comprising of 5mm and 20mm will be laid with the sticking material like Samad Bond or as required by the consultant as per manufacturer's specifications.

17.2.6 Bitumen

Bitumen shall conform to specifications of materials given in respective items of " Section-I Materials " and BOQ approved by the Consultants In-charge.

17.2.7 C/S Mortar

Cement sand mortar shall conform to specifications of materials given in respective items of " Section-I Materials " and BOQ approved by the Consultants In-charge.

17.3 CONSTRUCTION REQUIREMENTS

17.3.1 Inspection and Preparation of Roof Surface

Inspect all surfaces to receive roofing materials and water proofing, ascertain that they are sound, clean, smooth, dry and free of debris, loose material or defects which would have an adverse effect on the roofing application or performance. The cleaning and brushing the roof surface by wire brush should be given a due consideration before application of roof treatment and surplus stuff should be disposed of to out side the premises as directed by the Consultants In-charge.

17.4 Installation of Roofing

17.4.1 Over Flat Roof

- (i) Clear the roof slab from any un-suitable material.
- (ii) Apply two coats of SIB 10/20 hot bitumen at the rate of 25lbs. per 100 sq.ft. each coat over RCC slab.
- b] Apply one layer of 5mm-thick fabric based Bituminous (0.5mm thick aluminum foiled impregnated), laid 4" side laps and 4" end laps staggered with layers bonded together fire flash, and ensure that it is free of wrinkles.
- c] A layer of 2"- thick Chips screed comprising 1-part cement and 3-parts of marble chips 8 number finished smooth shall be laid to desired slopes and tiles shall be laid on a mortar bed (average thickness 1") to the required slopes as shown on plans. The preparation of mud plaster shall be as follows: -
- d] Brick tiles of specified size and first class quality shall be laid wet, grouted and pointed flush in cement sand mortar (1:3). The top surface shall be smooth and accurately level in accordance with the specified slopes. No brick or cracked tile to be used. Special Tiles for sloped roof shall be laid as per details shown on the drawings.

17.4.2 Sloped Roof, Vaults and Shades

- a] Split tiles rough glazed of size 9-1/2"x2- 1/4"x3/8" shall be laid in position over 3/8" thick special Dry bond mortar over 1/2" cement sand plaster (1:3) over RCC roof slab, vaults, shades. The tiles shall be grouted and flush pointed with special Dry Bond Mortar.

b] On drains near vaults, shades etc. 2 coats of Vandex Super over RCC slab.

17.4.3 Working Instructions of Applying of Vandex Super

Vandex Super in powder form shall be distributed over the concrete surface by means of a sieve with a sieve size of 2 mm just prior to trowelling the slab. The Vandex layer and the newly Cast Concrete shall be protected according to general description for concrete work. The Contractor shall co-ordinate the application of Vandex Super at the time of pouring and trowelling slabs.

17.5 CURING

Tiles, after laying, grouting and flush pointing is completed, shall be kept wet throughout for at least seven days.

17.6 PROTECTION

The Contractor shall take each and every care to maintain the slopes levels and shall protect the work from any damage. The Contractor shall have to remove, replace and rectify such damaged work at his own cost.

17.7 MEASUREMENT

The measurement under this item of specifications shall be made in Sq.Feet/M. of the actual surfaces completed and approved by the Consultants In-charge.

.....End of Section.....

18.1 DESCRIPTION

The work shall consist of Aluminum sections, constructed in reasonable close conformity with dimensions and standards detailed below and as shown on drawings/BOQ/manufacturer's specifications subject to the approval of Consultants In-charge.

The work covered under this section comprises of the following:

1. Furnishing, Fixing in position, anodizing/powder coating aluminum sections complete with handles, locks, nylon wheels, vinyl weather strips etc. as shown on the drawings and specified hereunder.
2. Fixing glass of specified quality and thickness to windows and door in accordance with the related items of BOQ and instructions of the Consultants In-charge.
3. This work also include any incidental construction not other wise provided for on the instructions of the Consultants In-charge.

18.2. GENERAL COMPLIANCE18.2.1 Design Requirements:

All doors, windows, railings, Handrails, etc. to comply with B.S. 4873 or equivalent in respect of materials, work sizes and manufacture. All sectional dimensions shown on drawings are only indicative. The CONTRACTOR shall be responsible to determine the adequacy of these with respect to actual structural and performance requirements. All extrusions shall be of adequate strength, not only to meet the structural performance, but also to minimize the risk of distortion in the finished surfaces.

18.2.2 Work Sizes:

All dimensions given on drawings are between structural openings and/or between finished surface and allowances shall be made for variation due to constructional tolerances. The CONTRACTOR shall be responsible to measure actual final dimensions from the Site before fabrication of doors, windows and other assemblies/units.

18.2.3 Weather Tightness:

Weather tightness and operations shall suit the weather conditions prevailing in the area of installation. All doors and windows will be fabricated as completely air and water tight units including gaskets for glazing, weather stripping, latches, locks, bolts for fixing etc.

18.2.4 Air Tightness:

The fixed glazed windows shall be as far as possible 100% air tight under all weather conditions.

Air infiltration for opening windows and doors when fully closed shall not exceed 3m³/hr/meter length of opening joint at a test pressure of 498 N/M as tested in accordance with B.S. 4315 part 1.

18.2.5 Acoustic Performance:

Windows when installed shall provide an average sound reduction of 28 dB over a frequency range of 100-3150Hz.

18.3 MATERIAL REQUIREMENTS

18.3.1 Aluminum Sections

All aluminum doors, windows, ventilators as shown on the drawings shall be fabricated with heavy-duty high strength aluminum extruded sections of aluminum alloy 6063-TS. Conforming to B.S 1474-1972 and B.S. 1470-1972 aluminum extrusions to be hard colour anodized in dark bronze with an average anodic film thickness of 20-25 microns and wall thickness should be 2.0mm and 1.6mm. The anodic treatment should conform to B.S. 3987:1974. Aluminum sections of approved manufacturer as directed by the Consultants In-charge. shall be used.

21.3.2 Iron Mongry

Fittings, handles, hinges/rollers, stopper/tower bolts and locks shall be of bronze, stainless steel and aluminum, push/pull plates of 100mm aluminum patterned on both sides of leaves, rollers imported nylon-tyres, sliding rust proof aluminum insect/fly screen as shown on the drawings or as stated in the Bill of Quantities or as directed by the Consultants In-charge.

18.3.3 Glazing

The solar control float glass if specified shall conform to the latest revised B.S. 952. "First grade imported tinted bronze float glass shall be used subject to approval The quality, kind, thickness and size of the glass shall be as shown on the drawings or called for in the Bill of Quantities.

The work of fixing glazing to doors, windows shall be carried out with the type and quality of glass specified for each door and window and as indicated in the drawings or as directed.

The glazing of "Antisun" float glass should be in accordance with the recommendations of B.S. C.P. 152 : 1972 and subsequent amendments.

The sizes of glass indicated on the drawings are approximate only, and the actual sizes required shall be determined by measuring the frames to receive the glass. All glass shall be factory labeled on each pane and the label shall not be removed until finally approved. Glass will be fixed with best quality mastic compound of approved make suitable for the type of glass or with special bead or molding as shown on the drawing or as directed. Special rubber lining and weather proof brush joints for sliding surfaces shall be provided where indicated.

Antisun' float glass shall be fixed using flexible compounds, sealants, performed strips or gaskets as per recommendation of the door/window manufacturer. The design shall allow for an edge clearance of at least 3mm (1/8") all around unless any dimension exceeds 1500mm (60") when the clearance shall be at least 5mm (3/16") edge cover shall be adequate to retain the glass in position under the design wind loading. The rebate depth clearance plus edge cover shall not be less than 11mm (7/16") for 6mm glass. The width of the rebate platform must accommodate the glass, the front and back compound, and glazing bead. The bead depth should not be less than the rebate depth. Setting blocks, distance pieces, and location blocks shall be used as appropriate.

Glass shall be protected against damage. After inspection, any labels, and paint spots shall be removed and glass shall be washed clean. Damages or broken glass shall be removed and replaced before acceptance at no extra expense. After the installation of 'Anitsun' float glass

it shall be cleaned using a soft cloth with water and mild soap or liquid detergent, followed by rinsing with clean water and drying.

18.3.4 Sealants:

The external joints between the building openings, window frames etc. shall be formed to details shown on drawings and grooves shall be caulked with mastic sealants. External jointing sealants are to be suitable for the type and exposure of building. Material shall not be of a standard lower than one part polysulphate rubber sealant conforming to B.S 5215 and shall be applied strictly in accordance with the manufacture's instructions. The colour and quality of sealant shall be subject to approval. Where joints to be sealed are deep the sealant must be supported by suitable polythene backing.

18.3.5 Weather stripping:

All opening section must be weather stripped with Neoprene glazing gaskets or as approved by the Consultants In-charge. and polypropylene pile weather stripping around doors to ensure adequate weatherproofing. Aluminum glazing beads are to snap on type without visible fixing and must be adjustable to allow for varying thickness of glass.

18.4 SAMPLES

18.4.1 The Contractor shall submit, for approval, samples of each type of door, window, ventilators etc. showing the quality of materials, workmanship and finish. The samples of iron mongery, fittings and fixtures shall also be got approved before the Contractor makes purchases.

18.4.2 The samples of glass for each type of glazing along with specifications of the manufacturer of special quality shall be submitted for approval before firm orders are placed for supplies.

18.4.3 The contractor will submit the manufacturer's specifications to the Consultants In-charge. for powder coating elements and of microns in case of anodized material, before execution.

18.5 CONSTRUCTION REQUIREMENTS

a) FIXING

The fixing of aluminum doors, windows, ventilators etc. to concrete/masonry openings shall be carried out in approved method as indicated in the drawings or as directed by the Consultants In-charge. Provision of necessary grooves or rebate and holdfasts in the concrete shall be made in the formwork and no holding or drilling shall be allowed in the exposed concrete finishes. These shall be executed in position after the building structure is completed and by using proper holdfasts as shown on the drawings or counter sunk bolts and screws as per site requirements

An approved manufacturer in this trade shall manufacture the aluminum doors and windows.

If required, the Contractor shall provide shop drawings based on Architectural drawings for the approval before orders are placed with the manufacturers.

The manufacturer shall use the latest and approved method of jointing employed in the manufacture of high class work viz. mechanical jointing, reinforced with concealed welding shall be used in the manufacture of doors and windows.

The workmanship shall conform to applicable provision of B.S. 990:1970.

b) WIND PRESSURE

The Design wind speed to which the various elements of glazing and framing will be subjected to shall be calculated in accordance with B.S. CP-3 and the following wind loads/speeds are to be taken into account:

Wind Velocity at 85 MPH
Height Less than 30' - 16 lbs/sq.ft.
Height 30' to 50' - 18.5 lbs/sq.ft.
Height 50' to 90' - 21.18 lbs/sq.ft.
Height 90' to 120' - 25.00 lbs/sq.ft.

All assemblies must be of appropriate shape, thickness and sections, to enable them to resist the loads produced by repeated imposed wind pressures. The maximum deflection over clear span of any member shall be such that it does not induce cracking in glass panels and render the assembly unsafe. No member shall suffer any permanent deformation. No part of the work shall rattle during use.

c) HANDLING

Care shall be taken in handling metal doors, windows, etc., during transportation and at site. These shall be stored under cover and shall be installed only by skilled mechanics, set plumb, level, in alignment and properly braced to prevent distortion.

18.6 PROTECTION:

- a) The joint between window and doorframes and the building should be caulked with approved building mastic for total weatherproofing.
- b) After installation, doors, and windows shall be protected from construction hazards that will interfere with their operation or damage their appearance or finish. They shall be cleaned on inside and outside of all mortar, plaster, and paint of other foreign matter to present a neat appearance. Hardware and moving parts shall be lubricated.

18.7 RATE AND PAYMENT

Rates for all items under this section shall cover the cost, of furnishing all the material, labour, scaffolding and appliances at site and performing all operations in connection with their installation in accordance with the instructions of the Consultants In-charge. and BOQ. It is particularly mentioned that the rates for fixing doors, windows, ventilators etc. shall include iron mongry fittings such as handles, push plates, stainless hinges, door closer, towers bolts etc. as specified and indicated on drawings and given in the BOQs, including cost of fixing and supplying glass with the instructions of the Consultants In-charge.

18.8 MEASUREMENT

Payment for doors, windows, ventilators etc. will be made by measuring clear opening area in brickwork or concrete in square feet/meters.

.....End of Section.....

19.1 DESCRIPTION

The work covered by this section of Specifications consists of furnishing all labour, painting and polishing equipment, scaffolding, protective covering and materials, including that classified in particular as "Paint" hereinafter; and painting in performing as such, all plastered wall and ceiling surfaces, including soffits, sides of beams, etc. and the painting and polishing of all exposed interior metal work; miscellaneous and ornamental iron, steel and sheet metal and all wood work. The work under this section shall further conform to the requirements of British Standard Code of Practice CP: 231:1966, "Painting of Building" and all the British Standards relied therein or bearing relevance.

19.2 GENERAL

19.2.1 Where the word or term Paint and Polish is used or referred to 'as such' throughout the "Specifications, it shall be interpreted to mean and include the surface finish treatment consisting of any, all or some of the following items:

Sealers, primers, fillers, body and final coats, emulsions, varnish, shellac, stain or enamels, as more specifically defined hereinafter as to kind and quality and function for various surfaces and finishes.

19.2.2 All paint, polish and accessory material incorporated in or forming a part thereof shall be subject to the Approval and selection for colour, tint, finish etc. by the Consultants.

19.2.3 The determination of colour or tint of any particular surface, the depth of any colour or tint selected or required shall in no instance be a subject for an additional cost or charge.

19.2.4 Painting of wood, except if specified otherwise and for plaster surfaces shall be three (3) coat work in addition to the shop protection coats.

19.2.5 All paints shall be approved as manufactured locally and shall be brought on to the Site in sealed containers and used without any admixture or adulteration except where recommended in the Manufacturer's printed instructions.

19.2.3 MATERIALS

19.3.1 The basic materials entering into the compounding and/or manufacture of all paints, varnishes, shellac and other finish treatments shall be of the best grade and quality of their respective kinds for the intended purposes. They shall be the products or formulas of recognized and reputable Manufacturers of known reliability and integrity as approved.

19.3.2 All materials shall be delivered in their original unbroken containers or packages and bear the Manufacturer's name, label and brand, and formula and be mixed and applied in accordance with his directions and/or instructions. The mixing of all paint or other covering finish treatments shall be done in the premises when required and as Approved.

19.3.3 Paints shall be well ground, shall not settle badly, cake or thicken in the container, shall be readily broken up with a paddle to a smooth consistency and shall show easy brushing properties. The paint shall be suitable for spraying when thinned with not more than twelve (12) percent by volume of mineral spirits.

19.3.4 Paints shall be lime-proof where used on concrete blocks, concrete or plaster.

19.3.5 Unless specified or directed otherwise, plastic emulsion paint shall be DULUX or equivalent, oil-bound distemper shall be PAINTEX Vinyl Emulsion or equivalent, colour wash shall mean colored chalk applied with gum at the rate of five (5) pound per bag of chalk, and snow cam shall be DUROCEM or equivalent. Synthetic enamel paint shall be SUPER GLOSS or Approved equivalent.

192.4 PROTECTIVE PAINTS

19.4.1 Unless otherwise specified all exterior and interior ferrous metal except reinforcing steel, bolts, rough hardware and metals with nonferrous coatings shall be given a shop coat of protective paint of Approved quality. Surface to be painted shall be thoroughly cleaned of scale, dirt and rust by the use of steel scrapers, wire brushes and blast or other equally suitable tools or methods. Oil and grease shall be removed with benzene or other suitable solvent. Paint shall be kept well stirred whilst it is being applied.

19.4.2 No paint shall be used after it has caked or hardened. Paint shall be well worked into all joints and corners; paint shall not be applied to damp surfaces nor when the temperature is below 40 degree F.

19.5 SAMPLE AND TEST

Samples of each type of paint and each colour proposed for use shall be submitted for Approval thereof before the material is used. Samples shall consist of one pint and three displays of each type and colour of paint applied to wood strips 2" by 6". Wood used for display stains, shall be the same kind as that on which the stain is ultimately to be applied. In addition to the submission of samples, the CONTRACTOR shall submit authenticated reports of tests of the materials proposed for use as may be required.

19.6 PREPARATION OF SURFACE AND APPLICATION OF PAINT

19.6.1 General

Hardware, accessories, plates, lighting fixtures and similar items in place shall be removed prior to painting operations or shall be otherwise protected. All surfaces to be painted shall be clean, smooth, dry and free from dust, grit and other objectionable materials. All work shall be done in a workmanlike manner, leaving the finished surfaces free from drips, ridges, waves, laps and brush marks. Except if specified or required, cement water paints shall be applied under dry and dust free conditions and shall not be applied when the temperature is below 40 degree F nor when a temperature drop of 20 degree F or more is forecast. All primer and intermediate coats of paint shall be un-scraped and completely integral at the time of application of each succeeding coat. Each coat of paint shall have a slight variation of colour to distinguish it from the proceeding coat. Sufficient time shall be allowed between coats to ensure proper drying. Paints shall be thoroughly stirred and kept at a uniform consistency during the application and shall not be timed in excess of the printed directions of the Manufacturer. Paint containers shall not be opened until required for use. Paint shall preferably be applied by the spray/brush/ roller or as directed. Drop cloths or other coverings shall properly protect floors, roofs and other adjacent work.

19.6.2 Concrete and Masonry

Concrete and masonry surfaces to be painted shall be prepared by removing all dirt, dust, oil and grease for good adhesion.

The method of surface preparation may be left to the discretion of the CONTRACTOR, provided the results are satisfactory and acceptable as required.

Surfaces to be painted with cement water paint shall be thoroughly dampened with a fine spray of water before application of the paint. The interval between coats of cement-water paint shall be not less than twenty four (24) hours, and the first coat of cement-water paint shall be slightly dampened before application of the second coat. The paint shall be applied with a stiff brush, and thoroughly worked into the surface to seal all pores, cracks and voids. The paint shall be cured by wetting the surface between coats, and at intervals for a period of not less than two (2) days after the application of the finish coat. Nails and similar exposed metal occurring in concrete or masonry surfaces shall be coated with shell or oil paint before the cement water paint is applied. Masonry surface to be painted with oil base

paint shall be free from alkali and shall be thoroughly dry before paint is applied.

19.6.3 Metal Work

Shop primed metal work shall be kept clean and free from corrosion following installation. Surfaces shall be retouched prior to finish painting, using the same type of paint as the priming coat.

19.6.4 Plaster Work

Plaster shall be at least two (2) months old (or less if allowed in writing and shall be thoroughly dry, clean, and free from grit, loose plaster, and surface irregularities before paint is applied. Cracks and holes shall be repaired with patching plaster such as plaster of Paris properly keyed to the existing plaster. All plaster surfaces shall be tested for the presence of Alkali, which if present, shall be removed with a solution of Zinc Sulphate mixed in the proportion of 2-1/2 to 3 pounds to a gallon of water. After drying, the precipitate shall be removed by brushing. Plaster patches shall be worked to match the appearance of the adjoining plaster.

19.6.5 Wood Work

Small dry seasoned knots shall be thoroughly cleaned and scraped and shall be given a thin coat of orange shellac varnish before the priming coat is applied. Large, open, unseasoned knots and all beads or streaks of pitch shall be heated by a blowtorch and then scrapped off, or if the pitch is still soft, it shall be removed with mineral or denatured alcohol. Resulting voids, if any, shall be filled with putty. Nails shall be set. Painting shall proceed only when the wood is satisfactorily dry.

(1) Priming

All millwork specified to be painted, shall be primed on all sides in the shop before delivery to the job.

(2) Puttying and Glazing

After the priming coat has been applied, nail holes, cracks, and other depressions shall be filled flush with putty, coloured to match the finish coat and sand papered smooth. Putty shall be dry before subsequent painting.

Glazing, rebates and bends in exterior glazed doors shall be given one coat of exterior primer before glazing. All exposed putty shall be painted. A minimum of two subsequent coats of paint shall be applied and the surface finished satisfactory as specified.

19.7 SCHEDULE OF PAINT FINISHES

19.7.1 Chalk/Colour Wash

Three coats of Approved quality shall be applied to all ceilings and other places as directed.

19.7.2 Distemper

Three coats of Approved washable oil bound distemper shall be applied to internal wall or at locations as directed as per Manufacturer's instructions and direction. The distemper shall be of required shade and shall be the product of reputable of Manufacturer subject to the Approval.

19.7.3 Emulsion Paint to Plastered Surfaces

Plastic Emulsion Paint or vinyl Emulsion Paint shall be used as indicated in the Bill of

Quantities.

The plastered surfaces required to be painted with emulsion paint shall be painted with ready made Approved paint of the kind. The paint shall be applied in three coats strictly according to Manufacturer's instructions including preparing base coat. The paint may preferably be applied by spray or roller method of application unless permitted otherwise.

19.7.4 Enamel Paint to Plastered Surfaces/Wood Work/Steel Work

The plastered surfaces required to be painted with enamel paint shall be painted with ready-made Approved paint of the kind. The paint shall be applied in three coats strictly according to Manufacturer's instructions including preparing 'base coat'. The painted surface shall finally exhibit a glossy finish as Approved. This will also apply to hard woodwork or wherever required.

19.7.5 White Wash/Colour Wash

Concrete, concrete block and plaster shall be painted with three (3) coats or white/colour wash.

The lime should be slaked at Site with an excess of water to the consistency of paste/cream and should remain under water for forty eight (48) hours. The mixture shall then be strained through coarse cloth and gum water added (having 60 gramme gum to one (1) pint of water).

Colour washing shall be prepared as for white wash and colour added. The colouring matter is to be boiled and gum added to it and strained into white wash.

19.7.6 Painting to Wood Work

Woodwork required to be painted shall be painted with Approved oil paints as follows:

After surface preparation as specified apply one coat of wood primer.

After wood primer has thoroughly dried, apply three (3) coats of oil paint of Approved manufacturer directly from containers strictly according to the Manufacturer's instructions.

19.7.7 Painting on Metal Work

Except if specified otherwise all metal work shall have, in addition to shop primer coats, one coat of enamel under-coat and one coat of semi gloss (dull) enamel, as well as two coats of anticorrosive red oxide paint.

19.7.8 Cement-Water Paint

Preparation of surfaces: Before the application of the cement water paint, all holes in joints or masonry surfaces shall be filled with mortar and suitably tooled. Caulking installed around wood or metal frames built into masonry, shall be thoroughly checked. Masonry shall be clean

and free from dust, dirt, grease or any other material which might affect the proper adhesion of paint.

Application of cement-water paint: Paint shall be mixed in accordance with the Manufacturer's directions and allowed to stand thirty (30) to forty five (45) minutes. Before application, the paint shall be mixed to uniform consistency and stirred frequently during application. Spraying several minutes between coats for the moisture to penetrate shall uniformly dampen the surface. Paint shall be applied with a brush having relatively short,

stiff, fiber bristles, scrubbing the paint into the surface voids. Keeping the surface damp for at least twenty four (24) hours shall cure the first coat; the surface shall be sprayed as soon as the paint has hardened sufficiently to resist injury and the spraying repeated as often as necessary to keep the surface damp before applying the second coat. The second coat shall be applied in such a manner as to completely cover the first coat as specified above, except that curing shall be continued as long as practicable, and for not less than forty (40) hours. Paint shall be applied in shade rather than in bright sun light, especially during warm windy weather. In applying the finish coat an entire wall surface shall be completed in one operation. If this is impracticable, painting shall be carried out to some expedient stopping point.

19.7.9 Interior Painting

Interior painting shall include the finishing of all ferrous metal work, wood work, concrete, concrete block, and plaster. Exposed pipes, pipe coverings, ducts, conduits, panel boxes, and other exposed ferrous metal work, for plumbing and electric work, shall be painted with wall or ceiling surface on or near which they occur, except where such surfaces are painted with resin emulsion paint, in which case the pipes, conduits, etc. shall be finished with three (3) coats of exterior oil paint. Pipe coverings, shall be sized with glue before being painted. Motors and other equipment for plumbing and electric work shall be painted as specified. Galvanized work shall be prepared in an Approved manner before being painted.

Interior wood work shall be finished as specified for exterior wood work except that the varnish shall be an interior varnish instead of a spar varnish. Wherever indicated on the Drawings, interior wood work shall be either painted or polished with sufficient coats of Approved paint or polish.

Concrete, concrete block and plaster shall be given three (3) coats of PAINTEX Vinyl Emulsion distemper including primer coat, wherever indicated on the Drawings.

Concrete, concrete block and plaster shall be painted with one coat of primer and two coats (or as specified) of DULUX Paint including finishing coat wherever indicated on the Drawings.

19.7.10 Weather Shield Paint

Weather shield paint shall be of ICI Dulux or approved equivalent and shall be as per manufacturers specifications. It shall be used on exposed surfaces wherever indicated on the drawings. It is a water thinnable emulsion; pigmented with light fast, alkali resistant non-lead pigments and contains a mould control additive. It is suitable where alkali resistance and exterior durability are the prime requirements. Brush, roller or conventional spray shall apply it.

19.7.11 All Rounder Paint

VIP all rounder interior super matt paint shall be of Berger Robbialac or approved equivalent. Brush, roller or spray Thin shall apply it where necessary with mineral turpentine. It is re-coat able in 6-8 hours under normal conditions. All-rounder paint shall be applied to surfaces wherever indicated on the drawings.

19.8 BURIED PIPING

All steel piping and all exposed threads of galvanized piping, where run in or through concrete or masonry, or buried under ground, shall be given one (1) coat of Approved asphalt varnish where specified.

19.9 SAMPLES

Prior to the start of the application of any paint and/or finish treatment otherwise, the CONTRACTOR shall apply samples of the required finish treatments to specific representative wall and ceiling surfaces or other areas or surfaces where indicated.

19.10 PROTECTION

CONTRACTOR shall protect all the work against damage or injury by his employees, or by the materials tools or utensils used in connection with the work of this CONTRACT. Any and all work damaged as a result of the execution of this CONTRACT shall be repaired at the CONTRACTOR'S expense, or if it cannot be properly repaired the CONTRACTOR without additional compensation shall replace it with new work therefore beyond the CONTRACT amount. At all times, the general and liberal use of drop cloths shall be a primary requirement for protection purposes.

19.11 TOUCHING-UP

At the completion of all Work specified herein all painted work shall be touched up and restored where damaged or defaced and the entire Work left free from blemishes.

19.12 CLEANING

The CONTRACTOR shall clean all paint, spots, daubs, oil and stains, entirely from all floors, wood-work, glass, hardware, metal work and all similar items upon completion and level the work in perfectly clean condition in ever respect.

All cloth and cotton waste, which might constitute a fire hazard shall be placed in metal containers or destroyed at the end of each work day. Upon completion of all work all staging, scaffolding, and containers shall be removed from the Site or destroyed in a satisfactory manner.

19.13 WAX POLISHING TEAK DOORS AND FRAMES

Surfaces to be Wax Polished shall be rubbed down to a smooth surface filled as necessary, dusted off and rubbed over with miner oil well rubbed in with a circular motion. The surface afterwards being wiped dry. After an interval of at least 48 hours wax polish shall be applied in two coats and shall be polished to an approved finish.

19.14 MEASUREMENT

The painting and finishing on all surfaces, other than timber and steel works, which shall be deemed to be inclusive of painting and finishing in their own items of work, shall be measured and paid for at the unit rates entered in the Bill of Quantities. Where separate quantities for paintwork are not shown in the Bill of Quantities, they shall be taken to have been already included in the rate of items to be finished and painted.

.....End of Section.....

20.1 DESCRIPTION

The work covered under this section consists of fabricating, supplying, fixing, and installing all cast-in place inserts including plates, bolts, nuts, all balustrades and handrails, steel gates all inserts and anchor bolts to be instead and/or grouted after the concrete or masonry work is executed and all miscellaneous metal work in connection with the installation of equipment, sanitary installations and mechanical plant that the contractor may be called upon to execute.

20.2 DRAWINGS, CATALOGUE CLIPPINGS AND SCHEDULES

The Contractor shall furnish complete shop drawings and manufacturers, specification, where applicable, in respect of all work falling under this section for approval. Material fabricated or delivered to the site, before the approval of shop drawings shall be liable to be rejected. Shop drawings shall show in detail the method of construction, erection data, materials list, and required connections. Schedules designating location, quantity and finishing details of each item shall accompany every shop drawing.

The shop drawings, schedules and manufacturer's data, if any, submitted by the Contractor shall be modified or revised, as required. When revisions are required either to drawings, schedules or manufacturer's data, they shall be resubmitted for approval.

20.3 CO-ORDINATION WITH OTHER TRADES

All work under this section shall be coordinated with the work to be done as specified under other sections of the specifications.

The Contractor shall furnish all information and instructions required for work by other trades.

The Contractor shall drill, tap, cut and fit the work included herein as required, to accommodate work of other trades in conjunction with it.

20.4 SAMPLES

Samples of all materials specified shall be submitted for approval.

20.5 MATERIALS20.5.1 a] Steel Plates and Sections

Items involving steel plates and sections shall be made of mild steel conforming to the requirements of latest Pakistan Standards and/or B.S./ASTM Standards Specifications.

20.5.2 b] pipes

If and where required pipes shall be full standard weight, of galvanized steel, mild steel or of cast iron and of sizes as indicated. Fittings, including clamps, shall be standard, malleable, galvanized, and of the best kind manufactured in Pakistan.

20.6 GENERAL

This section of the Specifications is intended to cover all miscellaneous items of various metals which are not specifically called for in other sections of these Specifications, Item shown or called for on the drawings, but not itemized herein, shall be furnished under the Conditions of this section and shall generally conform, as closely as possible to these Specifications unless otherwise directed.

20.7 CONSTRUCTION REQUIREMENTS

20.7.1 Fabrication

- a) Metal shall be well formed to shape and size, with sharp line or angles. Shearing and punching shall leave clean, true lines and surfaces. Permanent connections shall be welded or riveted as shown on the drawings. The use of screws or bolts shall be avoided but where used, heads shall be counter sunk screwed on tight, and the threads nicked to prevent loosening. Curved work shall be evenly sprung. Casting shall be sound and free from warp, holes and defects that impair their strength and appearance. Exposed surfaces shall have a smooth finish and sharp well-defined lines.

Machined joints shall be milled to a close fit. Necessary rabbets; lugs and brackets shall be provided so that work can be assembled in a neat and substantial manner. Fastenings shall be concealed where practicable. Thickness of metal and details of assembly and supports shall give ample strength and stiffness. Joints exposed to weather shall be formed to exclude water. Holes and connections shall be delivered and fixed in position at the proper time. All the work shall be installed in an approved and rigid manner, and where possible, shall be secured with galvanized toggle or double Cinch type expansion bolts.

Installation

20.7.2 _____

1 All the item of work under this section of the Specifications shall be installed in accordance with manufacturers drawings and directions to ensure proper and smooth operation of moving parts.

20.7.3 Painting

All ferrous metal surfaces except working parts machinery, galvanized surfaces and other surfaces not normally painted, shall receive one coat of rust inhibitive metal primer to red lead paint and two coats of finish painting with enamel paint for which no separate payment shall be made to the Contractor.

20.7.4 Protection

All materials included herein shall be delivered to the site in satisfactory condition, and adequate precautions shall be taken to protect all material from damage and rust. Any portion that has been damaged will be rejected and shall be replaced with approved materials at contractor's cost. Installed material shall be protected from damage and rust until the works have been completed and handed over.

20.8 BUILT-IN-ITEMS

All items of miscellaneous metal, which are to be built into the structure of the building, shall be furnished as required during the progress of the work.

20.9 WELDING

Welding shall be continuous along entire line of Contact, except where spot welding is indicated on the drawings or so authorized. Exposed welds shall be ground smooth except otherwise directed.

20.10 RIVETING

Riveting where exposed, shall be flush unless otherwise indicated or directed.

20.11 BOLTING

Bolting where permitted shall be done with properly sized bolts. Nuts shall be drawn tight and threads nicked.

20.12 STAIR CASE RAILING

Unless otherwise Specified, the stair case railing shall comprise of 5/8" (16 mm) square mild steel balustrades 2'-6" to 3'-0" (762 mm - 914 mm) high (clear above the steps). The balustrades shall be as indicated on the drawings and shall be anchored/embedded in the staircase concrete as shown. The top of each bar of the balustrades shall be ground to a round shape to receive the M.S. flat. The M.S. flat shall then be continuously welded around the bar and the weld ground clean to a 45 degree centigrade angle fillet. It will be the contractor's responsibility to manufacture and install the balustrades so they are perfectly aligned and to finish the entire railing.

Ends of the M.S. flat shall be turned 90° and fixed to a 5"x5"x1/4" (127mmx127mmx6mm) M.S. plate embedded in the masonry or concrete wall as shown on the drawings.

1 The handrail adjacent to the wall shall be anchored into masonry or concrete wall at 3'-0" c.c. (914 mm) or 1 as shown on the drawings.

20.13 MEASUREMENT

All the items under this section of these specifications shall be measured paid for at their respective unit rates as entered in the Bill of Quantities and as shown on drawings.

- a) Stair Case railings shall be measured per Linear Ft./M. complete and installed and acceptably¹¹ completed and approved. On the longitudinal center line along the finished hand rails up to the un-recessed face of the walls on which their ends are fixed.
- b) Other items covered under this section shall be measured under the head of the specific items in connection with which they are required to be¹¹ executed.

.....End of Section.....

21.1 SCOPE OF WORK

The work covered under this section consists of fabricating, supplying, providing, fixing, installing, Laying, Cutting, Bending, Erecting The Fiber Glass Work over framed structure or indicated on drawings according to the manufacturer's specifications as directed/approved by the Consultants In-charge.

21.2 GENERAL

The fiber glass should be of EM 100 Chopped Strand which provides improved Strength, stiffness, temperature resistance and dimensional stability to the matrix and compatible with most polyester and vinyl ester resins for contact moulding or hand lay-up.

It should meet the requirements of ACI Fiberglass EM 100 Chopped Strand Mat certified by Lloyd's Register of Shipping, London, following compliance with Lloyd's stringent performance criteria.

21.3 PRODUCT AND PRODUCT TYPE

Product	EMULSION MAT 100
Product Type	CHOPPED STRAND MAT

21.3 MATERIAL PROPERTIES

Glass strands should be of low alkali 'E' glass which result in excellent laminate mechanical strength, long term durability and good electrical resistance as produced by ACI Fiberglass and approved by the Consultants In-charge.

The individual glass strands should approximately be 50mm long and randomly distributed to give minimum orientation of glass fibers so that it may ensure consistent laminate strength independent of the direction in which the mat is laid into the laminate.

The chemical coating or size applied to each filament of glass should compatible with Polyester and vinyl ester resin types, and will contains a silane coupling agent to effect a superior bond between the glass and resin. The Silane coupling agent is also less affected by moisture and other types of coupling agents, which assists long-term strength retention and gives the laminate good weathering performance.

The glass strands must be bounded by a poly vinyl acetate emulsion binder, which gives the mat excellent strength and flexibility for easy handling off the roll, whilst retaining the ability to cut to pattern or tear to size.

21.4 PERFORMANCE

The binder should produce fast wet through together with superior moulding performance like EM 100. It also should release entrapped air excellently and a minimum of springing or bridging of glass fibers. These properties enhance conformability to mould surfaces.

Resin to glass ratios should range from 1.5 : 1 to 3.5 : 1, which should demonstrates the true general purpose' nature of EM 100.

21.5 TYPICAL LAMINATE MECHANICAL PROPERTIES

Property	Test Method	Typical Value
Tensile Strength Dry	ISO 3268	90 Mpa
Tensile Modulus Flexural Strength Dry	ISO 3268	8500 Mpa
Wet Flexural Modulus	ISO 178	190 Mpa 160 Mpa
Glass Content	ISO 178 ISO 1172	7500 Mpa 30%

Laminates should contain a nominal 1800 g/m² of reinforcement using an orthophthalic resin in accordance with Lloyd's Register and approved by the Consultants In-charge. The laminate will be cured for 24 hours at 16 °C - 20°C and post-cured for 16 hours at 40°C. Wet strength will be measured after immersion in boiling water for 2 hours.

21.6 GENERAL INFORMATION

Density (g/m ²)	Roll Width(m)	Nominal Roll Wt.(kg)	Nominal Roll Lgth.(m)
300	1	30	100
450	1	31.5	70
600	1	32	53
900	1	32	36

21.7 PACKAGING

Rolls of mat are contained in a plastic sleeve to prevent penetration of moisture. Each roll is packed in an individual cardboard carton. 16 cartons are shrink wrapped on to a standard pallet.

21.8 LABELLING

A colour coded label is adhered to top flap of carton -details include type of mat, density, roll width, production code and roll weight.

21.9 FRAMED STRUCTURE

As per drawings, the relevant BOQ's item and as per instructions approval of the Consultants In-charge.

21.10 SAMPLING

The contractor will submit the samples of each relevant material before executing the Fiber-glass work to the Consultants In-charge and got approved.

21.11 MEASUREMENTS AND PAYMENTS

All the items under this section of these specifications shall be measured paid per Sft. at their respective unit rates as entered in the Bill of Quantities and as shown on drawings.

.....End of Section.....

SECTION-22

Misc.

As per Drawings, BOQ and to the entire satisfaction of the Consultants.

.....End of Section.....

TECHNICAL
SPECIFICATIONS

(PUBLIC HEALTH WORKS)

GENERAL SPECIFICATIONS OF PLUMBING WORKS SECTION-1

1.1 GENERAL

The stipulated therein, the direction as given below shall invariably be read with relevant clauses of Condition.

The materials used and workmanship shall be of highest quality and grade unless otherwise specified shall. Conform to the latest specifications of British Standards and Codes of Practice "Water Supply", "Sanitary Pipe Work", "Building Drainage", "Surface Water and Sub-Soil Drainage" and applicable to details and work indicated on the Drawings and Bill of Quantities. In case of any discrepancy/ambiguity the decision of the Consultants shall be final, and the Contractor will act and perform accordingly.

1.2 DRAWINGS AND INFORMATION REQUIRED

- a) The Contractor shall submit shop drawings for the entire installation including installation details for all items required or asked for approval of the Consultants.
- b) Approval by the Consultants of shop drawing for any material, apparatus, devices and layout, shall not relieve the Contractor from the responsibility of furnishing same of proper dimension, size quantity and all performance characteristic to efficiently perform the requirements and intent of the Contract Documents. Such approval shall not relieve the Contractor from responsibility for errors of any sort in the shop drawing.
- c) If the shop drawings deviate from the Contract Documents the Contractor shall advise the Consultants of the deviations in writing accompanying the shop drawings including the reasons for the deviations. At the start of the Project the Contractor shall periodically and thereafter submit to the Consultants a list of all shop drawings, which will be submitted in the course of the project. The list shall show the disposition of each item including date of submission approval etc. The list shall be kept up to date through the entire course of construction.

1.3 CLEANING AND PROTECTION

- a) The Contractor shall be responsible for his work until its completion and final acceptance, and shall replace any of the same, which may be damaged, lost or stolen without any additional cost to the Owner.
- b) The openings left in floor for passage of lines of soil waste, vent and supply pipes shall be covered and protected.
- c) The pipes shall be protected with suitable covering as soon as set. All open ends of pipes shall be closed by a plug fitting to prevent obstruction and damage. The use of new permanent water closets and other new plumbing fixtures during the progress of work is prohibited.
- d) As soon as installed, all metal fixtures trimmings shall be thoroughly covered by this Contractor with non-corrosive grease, which shall be maintained until all construction work is complete
- e) Upon the completion of the work, all fixtures and trimmings shall be thoroughly cleaned and polished and left in first class condition.
- f) Prior to delivering the plant to the Owner the Contractor shall thoroughly clean all equipment fixtures, fittings etc.
- g) Before final connections are made and before operation of equipment and piping, all piping interior shall be thoroughly blowout, or washed out at least twice in a manner as directed by the Consultants all accumulation of dirt chips or other deleterious materials. Make all temporary connections and furnish all appliance required for the purpose of cleaning at no extra expense to the Owner.

- h) Before erection, all pipes, tubing, valves and fittings shall be thoroughly cleaned of oil, grease or other combustible materials by washing in a hot solution of sodium carbonate or trisodium phosphate mixed in the proportions of one pound to three gallons of water.

1.4 RECORD DRAWING

- a) During construction the Contractor shall keep an accurate record of all deviations between the work as shown on the Contract Drawings and that, which is actually installed.
- b) The Contractor shall secure from the Consultants after approval of his Shop Drawings a complete set of drawings and note changes thereon in ink.
- c) The Contractor shall make a complete record of all changes and revisions in the original design, which exist, in the completed work.

The cost of furnishing above prints and preparing these for record shall be deemed to be included in the tendered cost and its effect spread over other items of work, and as such item shall not be a subject to payment. When all revisions showing the work as finally installed are made, the corrected Original Transparencies shall be submitted to the Consultants for review and delivered to the Consultants before final payment for the completed work will be made.

1.5 OPERATING AND MAINTENANCE INSTRUCTIONS

Three sets of operating and maintenance instruction covering completely the operation' and maintenance of all plumbing equipment, controls, heaters, pumps and the like shall be furnished to the Owners.

1.6 TESTS

- a) The entire system of drains, waste and vent piping inside and outside the building shall be tested by the Contractor under a water test, which shall include the entire system from the lowest point to the highest pipes above the roof.
- b) The water test shall be made in accordance with all local requirements. Every portion of the system shall be tested to a hydrostatic pressure equivalent to at least 15 feet head of water. After filling, the Contractor shall shut off water supply and shall allow it to stand 2 hours under test during which time there shall be no loss or leakage. This test procedure shall apply to C.I. pipes.
- c) Interior and exterior water distribution systems shall be tested whole or in part to a pressure of at least 50 Psi gauge higher than their normal operating static or street main pressure, but no test shall be less than 150 Psi gauge. Each test shall be conducted in the presence of the Consultants and shall run for the two hours with no loss of pressure.
- d) The Contractor shall furnish and pay for device, material supplies, labor and power required for all tests. All tests shall be made in the presence and to the satisfaction of Consultants.
- e) Defects disclosed by the test, shall be repaired or if required by the Consultants defective work shall be replaced with new work, without any extra charge to the Owner. Test shall be operated as directed until the work is proved satisfactory.
- f) Fixture shall be tested for soundness, stability of support and satisfactory operation.
- g) The Contractor shall notify the Consultants at least one week in advance of making the required tests, so that arrangements may be made for their presence to, witness the test.
- h) Equipment shall be tested in service and the Contractor shall demonstrate that the equipment performs the work intended for it and that it complies with the requirement of these specifications for such equipment, to the satisfaction of Consultants.

.....End of Section.....

- f) Cast Iron Sluice Valve (size 3" and above)

Cast Iron body; Gunmetal spindle and sealing rings.

BS-3464, flange to BS-I 0; 1962.

Test Pressure = 225 Psi.

- g) Copper alloy sluice valve (size 2-1/2" and below)

BS-1952: threaded ends.

Test Pressure = 225 Psi

- h) Cast Iron Check Valves' (Size3" and above)

Cast Iron body; Gunmetal door.

Test Pressure =225 Psi.

- i) Copper Alloy Check Valve (Size 2-1/2" and below). Threaded ends. Test Pressure = 225 Psi.

- j) C.I. globe valves (Size 3" and above). Similar to Cast Iron Sluice Valve

- k) Copper alloy globe valve (Size 2-1/2" and below). Threaded, Test Pressure =225 Psi).

- l) Fire Hydrant shall conform to BS-750, with a body of Cast Iron and spindle of Manganese-bronze. The direction of closing shall be by Clockwise rotation and the outlet shall have screwed joints for accommodating 2-1/2" dia hose connection.

- m) Double air valve

Cast Iron body
Max. Working head

Dia (in.)	2	3	4	6
Head (ft)	200	575	575	575

- n) Pressure Reducing Valve

The valve shall maintain a constant downstream pressure regardless of changing flow rate and/or varying inlet pressures. It shall be spring loaded, hydraulically operated, pilot-controlled diaphragm-type globe valve. The valve shall have a single removable seat and resilient disc. The body and cover of the valve shall be of cast iron for valves of size 3" or above and shall be of cast bronze for size 2-1/2" or below. The inlet and outlet of valve shall be threaded for size 2-1/2" or below and flanged for sizes 3" or above. The working pressure for valve shall be 175 Psi minimum and the valve permit a convenient adjustment over a range of no less than 30 Psi. The threaded valve shall be installed with two unions at its inlet and outlet end of facilitate its removal. All pressure reducing valve assemblies will be installed with bypass line having globe valve/gate valves so that removal of P.R. Valve for servicing/repair will not disturb the service of that circuit.

o) Strainer

- i) The straight cast iron strainer shall be installed on the submerged end of suction pipe drawing water from ground water from reservoir. The strainer flange shall conform to the specifications of BS-10, 1962. Minimum length of strainer for the specified dia. shall be as follows:

Dia	Length
3"	5-11/16"
5"	7-1/2"

- ii) The strainers shall have cast iron or bronze bodies suitable to withstand the working pressure, removable screens of copper, brass, nickel or stainless steel, flanged bodies with tapping for size 1-1/2" and above and of such a design as to allow blowing out of accumulated dirt and easy removal and replacement of strainer screen without disconnecting the main piping.
- p) Puddle plates of specified dia, shall be provided where G.I. pipe crosses R.C.C. wall retaining water or soil. 3/8" thick M.S. square plate of size shown on plan, cut with a hole equal to external dia of pipe, shall be welded with the pipe with both ends of G.I. pipe provided with flanges, and the whole assembly shall be hot-dipped galvanized before being cast in R.C.C. wall.
- q) Float Valve, Level, Controller, and Flow Switch. Tender to provide Specifications of items locally available.
- r) Pipe Sleeves for Cast iron pipes

The Contractor shall supply and install the pipe sleeves in RCC walls and sleeves. The pipe sleeves shall be located accurately and they shall be properly aligned and tied with the reinforcement bars so that the alignment and level is not disturbed during concreting.

The RCC wall pipe sleeves shall be fabricated from correct size Schedule 40 M.S. pipe. M.S. 3/8" thick sheet ring of sleeve size +6" shall be welded at the centerline of the sleeve to anchor the sleeve in RCC structure. After fabrication, the sleeve shall be heavily galvanized before installation. The inner galvanized surface shall be smooth.
RCC slab pipe sleeves shall be of construction as above but fabricated from 3", 4", 5" and 8" dia Schedule 40 M.S. pipes and anchor ring shall be of 9-1/2", 10-1/2", 11-1/2" and 14-1/2" dia respectively.

- s) Pipe seal for cast Iron pipes

All exterior openings provided for the passage of piping shall be properly sealed with snugly fitting collars of metal or other approved rat-proof material securely fastened into place.

2.3 PROPERTIES AND REQUIREMENTS FOR DADEX PIPE

2.3.1 Jointing And Installing:(Jointing Methods Of Tigris Green)

A) Polyfusion Welding

- (i) Preliminary operations.

The surfaces of the pipes and fittings must be clean and without impurities. Pipes ends must be clean cut at right angles. It is recommended to cut 1m from the pipe ends in order to prevent possible micro cracking due to incautious handling.

Before carrying out the welding, check that the polyfusion device operates correctly and that it reaches the required welding temperature (260 C + 5).

(ii) Welding

Pipes and fittings are inserted up to the edge of the matrix and held steady without rotating. It is very important to stick to the heating times mentioned here below:-

Polyfusion welding times according to DVS 2207 norms.

Pipe (mm)	Heating (Min.)	Working time (Max.)	Cooling (Min.)
20	5	4	2
25	7	4	2
32	8	6	4
40	12	6	4
50	28	6	4
63	24	8	6

B) Welding By Means Of Electro- Fusion Couples

(i) Preliminary operations

The pipe must be clean cut at right angle. The parts to be welded must be cleaned with emery cloth or a manual scraper and the inside of the fitting socket has to be degreased with the suitable cleaning liquid. The pipes must be perfectly aligned.

(ii) Welding

After having connected the following machine compatible with the electro-fusion couples and started up the welding process, you can verify the good results by checking if the two pins have come out of their seats.

Wait at least two hours from last welding before the system is put under pressure.

2.3.2 Tigris Green Equipment And Tools

To install hydro- sanitary and heating systems using Tigris Green pipes and fittings the use of the following specific equipment is required:

- Pipe cutter 0-63
- Polyfusion device 20-63 (feeding 200 V)
- Male and female materials 20-63
- Welding machine for electro-fusion couples 20-225
- Bench welding machine 20-75

2.3.3 Exposure to UV-rays

It is recommended neither to store nor to install the product in places which are directly exposed to Ultraviolet rays.

2.3.4 Bending

Bending of Pipes will not be allowed.

2.3.5 Threaded joints

To ensure tightness, Teflon or similar products can be used.

2.3.6 Pipe cutting

Cutting should be carried out using tools, which ensure a clean cut free from burrs and perpendicular to the axis.

2.3.7 Low Temperatures

At temperatures below 0 c following precautions have to be taken.

- Pay attention when cutting the pipe
- Check the cut make
- Avoid impacts and excessive strains.
- Not to make elbows with very narrow radius.

In presence of cold draughts, welding must be carried out in protected areas, to avoid a quick cooling of the surfaces to be welded.

2.3.8 INSTALLING AND JOINTING KELEN) _____

1. Installing the pipes in the shaft

In practice the main riser can expand and contract laterally in the shaft between two floors if an anchor point is located next to the pipe that branches off from the main pipe. The distance between two anchors points in the shaft should not exceed 3.0 m. other methods can be used to accommodate the expansion such as expansion armor in the pipe branching off from riser.

2. Embedding the pipe

Pipe work that is embedded in the wall, floor, screed etc. is prevented from expanding. The pressure and tensile stress are absorbed without causing any damage to the material. If the pipes are installed (in compliance with national standards) then the insulating material provides further room for expansion.

2.3.9 Exposed pipe work

1. Preventing expansion by mechanical restraint d 20-50

Steel channels (KE88) can also be used to support pipe work.

The hangers are fixed to the channels, which are in turn fixed to the pipes (e/g using cable ties). This practice reduces the expansion rate of plastic pipes to that of steel pipes.

2. Accommodating expansion by expansion loops d 63-110

All changes in direction of pipe work can be used to accommodate linear expansion. However, in some cases an expansion loop (U loop) is necessary. This method is primarily used for pipe sizes above d 50.

The anchor points are positioned in such a way that the pipeline is divided into sections and the force of expansion can be guided in the desired direction.

Pipe support centers (in cm) for KELEN pipes transporting water

D mm	Pn10	20C PN	40C PN20	60C PN20	80C PN20
20	70	80	70	65	60
25	75	85	80	75	70
32	90	100	90	85	75
40	100	110	105	95	85
50	115	125	115	105	90
63	130	140	130	120	110
75	150	170	160	150	130
90	185	205	195	180	160
110	195	220	200	180	160
125	205				
160	220				

The pipe and fittings are joined by a self-regulating polyfusion welding machine, at a temperature of 260 C. Connect the machine to the electricity supply (220 V) and wait. When the green light starts to blink the welding temperature has been reached and work can begin.

2.3.10 Safety first

Cut 4-5 from each end of the pipe (the ends may have been slightly damaged during handling) for this purpose KELEN pipes is in 4.10 m lengths.

2.3.11 ELDING PROCEDURE

1. Ensure that the surface of the pipe and fitting are clean and free of grease.
2. Mark the insertion depth (equal to the socket depth of the fitting) on the pipe.
3. Heat the pipe to the insertion depth and the fitting to the socket depth on the welding tools.
4. When the heating time has elapsed (see table) push the pipe and fitting together smoothly and evenly. The result is a very strong and homogenous.
5. The position of the fitting can be adjusted for a few seconds immediately after the pipe and fitting have been joined (see table)
6. Within a short period of time (see table) the joint is capable of withstanding a full load.
7. The low weight and high flexibility of the materials makes it possible to weld whole sections of pipe work at the workbench. Take advantage of this and save much time.
8. Some joints will have to be made in the wall. Try to keep the area here the joint has to be made as accessible as possible.
9. Measure the correct length, not forgetting the depth of the socket. Pipe socket. Pipe secateurs are used for cutting pipes up to 40 mm. Pipes with larger diameters are cut with a wheel pipe cutter. If necessary the pipes can also be cut with a fine metal saw. Don't forget to insulate the pipes specified. The pipes can be covered with elastic insulating tubes (Kelinfix, Kelon etc.) before they are installed. This can of course be done later but it is more difficult when Pipes have already been installed in the wall.
9. The distance between the draw-off points at the wall can be set (in all standard distances) both horizontally and vertically with the template which is equipped with a spirit level.

2.3.12 KELEN WELDING MACHINE FOR LARGE DIAMETERS

1. Screw the heating elements. For the desired diameter to the heating mirror.
2. Insert the Reducers for the desired diameter in the clamp.
3. The clamps for the fitting are reversible. For d 20-d 40 use the small clamps and for d 50-90 use the large clamp. Secure the fitting in the clamp.
4. Select the centering bushing for the required dimension and release the centering lever. Bush the centering bushing into the fitting and tighten the centering lever.

The axial alignment must be repeated for every change in pipe diameter or whenever the welded joint is uneven.

5. Pipe diameter switch

This switch determines the insertion depth the pipe in the fitting. Set to the required diameter.

The Welding Procedure

1. Place the pipe in the clamp without tightening. Press down the spacing button and do not release. Move the sliding blocks with the hand wheel until the end of the pipe is touching the end of the fitting. Release the spacing button and secure the pipe in the clamp.
2. Separate the two sliding blocks and pull down the welding mirror. Roll the two sliding blocks together until they are held by the lock on the welding mirror. When the welding time has elapsed separate the sliding block and quickly remove the welding mirror.
3. Move the two sliding blocks together until the pipe diameter switch catches. Never cool the remove the welded joints. Once the cooling period has elapsed the joints is ready to withstand a full load.

2.3.13 Butt Welding machine for KELEN pn10 pipes

1. Loosen the screws and fit the required reducers in the clamps.
2. The end of the pipe should protrude from the clamps by no more than 30 mm.
3. Connect the following machine and start the motor. Move the two pipes together and applying a little pressure mill the pipes to remove the oxide layer at the weld zone (max. cutting thickness: 02mm). Ensure that the pipe ends are parallel to each other (max divergence: .03 mm). The pipe ends must not be offset by more than 0.5 mm.

2.3.14 IMPORTANT:

The pipe ends must not be touched and must be welded immediately. If this is not possible and the weld has to be made later then the welding zone must be cleaned and de-greased.

1. The welding procedure
2. Before welding begins read from the monometer the pressure required for advancing the mobile part and add this to the working pressure given in the table.

3. Never cool the joint suddenly. If the weld has been made correctly a double bead should be visible around the whole circumference of the pipe.
 4. Insert the heating element (Temp: approx 250C). Press the pipe ends on the heating element with the required joining pressure until a bead forms around the complete circumference of the pipe. During the reduced to the heating pressure once the heating time is over move the sliding blocks apart rapidly and remove the heating element.
 5. The change-over time (time between removing the heating element and welding the pipes) should be as short as possible.
 6. The welding pressure should be built-up as smoothly as possible during the specified pressure attainment time (mi.0, 15 n/mm²).
 7. The Welding pressure must be maintained during the cooling period.
- 2.3.15 Joining KELEN electro fusion sockets...

1. Cut KELEN pipe square to the axis.
2. Scrape the KELEN pipe with an appropriate tool (blade or scraper). Ensure that only a thin layer is scraped from the surface and that the nominal diameter is not reduced.
3. Chamfer the KELEN pipe with an appropriate tool (blade or scraper)
4. Thoroughly clean the end of the KELEN pipe and electro fusion socket where the weld is to be made. A cleaning tissue soaked in isoperpyl alcohol is supplied with the electro fusion socket for this purpose. Do not use oil-based solvents for cleaning.
5. To ensure that the weld is positioned centrally mark the insertion depth of the pipes with a pen. Ensure that the tracers points upward (45 deviation is permitted).
6. The operating instructions for the electro fusion socket-welding machine are located in the cover of the machine.
 - a. Connect to the electricity supply (220+/- 10%,50 Hertz) Attention: Ensure that the cable is completely unrolled to avoid inductive loss of voltage.
 - b. Connect the welding cable to the socket.
 - c. Press the start button. The machine calculates the welding time.
 - d. When the welding time has elapsed the machine switches itself off.
 - e. If there is a defect establish the reason.
 - f. Press the reset button before each further welding procedure.
7. Ensure that the electro fusion socket is axial to the pipe and is subjected to stress or strain welding.
8. Ensure that no moisture is present either inside or outside the weld zone.
9. Ensure that the weld is not subjected to stress, impact or moisture or any other strain during the cooling period (allows at least 10 minutes for cooling).

10. Wait for at least one hour before operating the system.

2.3.16 FITTINGS:

The following fittings shall be used to time relevant pipes:-
(TIGRIS)

TIGRIS GEEN pipes PN20 in 4m bars:

Code (380 004, 380 005, 380 006, 380 007, 380 08,380 009)

Coupler

Code (384 004,384 005,384 006, 384 007,384 008,384 009)

Electro- fusion coupler

Code (384 104,384 105,384 106,384 107,384 108,384 109)

Male/ female reducer

Code (380 554,380 564, 380 565, 380 574, 380 575, 380 576, 380 585, 380 586, 380 587, 380 595, 380 596, 380,597, 380 598)

90 elbow

Code (381 004, 0381 005, 381 006, 381 007, 381 008, 381 009)

Male/female 90 eblow

Code (381 244)

Female threaded 90 elbow

Code (381 014, 381 024, 381 015, 381 025, 381 026, 381 036)

Male threaded 90 elbows

Code (381 114, 381 124, 115, 381 125, 381 126, 381 136)

Female threaded 90 male elbows

Code (381 515)

Female threaded 90 elbow with supporting device

Code (381 304)

Male threaded 90 elbow with supporting device

Code (381 314)

45 elbow

Code (381 404, 381 405, 381 406, 381 407,381 408, 381 409)

90 Joint with spigot and nut

Code (381 624, 381 635,381 646)

"T"

Code (383 004, 383 005, 383 006, 383 007, 383 008, 383 009)

Reduced "T" fitting

Code (383 545, 383 646, 383 656, 383 747, 383 757, 383 767, 383 858, 383 868, 383 878, 383 959, 383 969, 383 979, 383 989)

Male threaded "T"

Code (383 114, 383 124, 383 115, 383 125, 383, 126, 383 136)

Bypass bend

Code (381 804, 381 805, 381 806)

Cap

Code (384 604, 384 605, 384 606, 384 607, 384 608, 384 609)

Female threaded "T"

Code (382 114, 382 124, 382 115, 382 125, 382 126, 382 136, 147, 382 158, 382 169)

Joint with spigot and nut

Code (382 324, 382 324 382 325)

(KELEN)

Pipe PN20

KE00 PN20 (d20-90)

SENSO- Pipe PN20

KE03 PN20 (d 20-25)

Socket Coupling

KE20 PN20 (d 20-90)

Elbow 90

KE20 PN20 (d 20-25)

Elbow 45

KE70 PN20 (d 20-25)

Elbow 90 (male/ female)

KE26 PN20 (d 20-32)

Elbow 45 (male/ female)

KE27 PN20	(d 20-25)
Equal tee	
KE30 PN20	(d 20-90)
Reducer tee	
KE35 PN20	(d 20-75)
Reducer tee	
KE36 PN20	(d 20-25)
Reducer (male/female)	
KE41 PN20	(d 20-90)
End cap	
KE60 PN20	(d 20-90)
Curved pipe	
KE90 PN20	(d 20-32)
Wall bracket 90	
KE83 PN20	(d 20-25)
Valve	
KE50 PN20	(d 20-25)
Male adaptor	
KE11 PN20	(d 32-75)
Female adaptor	
KE13 PN20	(d 20-32)
Female Adoptor	
KE13 PN20	(d 32-75)
Elbow adoptor 90(male)	
KE21 PN20	(d 20-32)
Elbow adoptor 90 (female)	
KE23 PN20	(d 20-32)
Tee (male thread)	
KE301 PN20	(d 20-32)
Tee (female thread)	

KE33 PN20	(d 20-32)
<u>Union (plastic-metal)</u>	
KE56 PN20	(d 20-90)
<u>Threaded adaptor</u>	
KE57 PN20	(d 20-90)
<u>E- repair socket</u>	
KE17 PN20	(d 20-90)
<u>Backing ring</u>	
KE18 PN20	(d 40-110)
<u>Flange</u>	
KE19 PN20	(d 40-110)
<u>Threaded connection for cavity walls</u>	
KE84 PN20	(1/2")
Stopper (Short)	(1/2:-3/4")
Stopper (long)	(1/2:-3/4")
<u>Polyfusion Welding programmed PN10</u>	
<u>Pipe PN10</u>	
KE02 PN10	(d 20-160)
<u>SENSO- pipe PN10</u>	
KE04 PN10	(d 20-25)
<u>Socket coupling</u>	
KE10 PN10	(d 110)
<u>Elbow 90</u>	
KE20 PN10	(110)
<u>Elbow 45</u>	
KE70 PN10	(110)
<u>Equal tee</u>	
KE30 PN10	(110)
<u>Reducer (male/female)</u>	
KE41 PN10	(110)

E- repair socket

KE17 PN10 (110)

Butt welding programmed PN10(Code ST)

Elbow 90

KE20 ST PN10 (d110- 160)

Elbow 45

KE70 ST PN10 (d110- 160)

Equal tee

KE30ST PN10 (d110- 160)

Reducer

KE41ST PN10 (d110- 160)

Backing ring

KE30ST PN10 (d110- 160)

Flange

KE19ST PN10 (d110- 160)

Accessories

Template

KE86L

Plugs for template

KE86D

Pipe channel

KE88 (d20- 90)

Flange seals

KE19A (d40- 160)

2.3.17 Samples:

Samples of all material shall be got approved before use from the Chief Architect. Manufacturer's test certificate shall be submitted to the Chief Architect stating that the pipes confirm to the specified grade/test pressure.

Material may further be got tested, it required by the Chief Architect at Contractor's cost. Rejected materials shall be removed from the Site of Works immediately and same type of materials as approved shall be used throughout the works.

2.3.18 TESTING OF PIPE LINES:

No work shall be covered over or surrounded with concrete until it has been tested by the Contractor and in the presence of Chief Architect and approved by him.

(a) Water pipes

After laying, joining and anchoring, the main should be slowly and carefully charged with water, so that all air is expelled then allowed to stand full for several days before testing under pressure.

The test pressure should be applied by means of a manually operated test pump or, in the case of long mains or mains of large diameter, by a power-driven test pump which should be not be left unattended. In every case precautions should be taken to ensure that the required pressure is not exceeded. Pressure gauges should preferably be re-calibrated before the test.

The test pressure may be the maximum working pressure at the point of reading plus 20 percent. The test pressure should be maintained by the pump for about one hour and if there is any leakage it should be measured by the quantity of water pumped into the main in that time. A general leakage of one gallon per inch of diameter per mile per 24 hours per 1000ft head may be considered reasonable, but any visible individual leak should be repaired. Any defective pipe-length joints fittings, and values any defective material shall be replaced or defective work rectified by the Contractor and retested for acceptance, all at contractor's cost.

2.4 CONSTRUCTION REQUIREMENTS

2.5 EXCAVATION & REFILLING OF TRENCHES FOR PIPE WORK

The trenches shall be set out to suit alignment of the pipelines. The trenches shall be carefully trimmed at sides and bottom so that pipelines when laid shall rest on the natural bed throughout the length. Shallow joint holes being left for the joint, where necessary. Where pipe line is to be laid in plains the depth of cover, i.e. the normal distance from ground level to other top of the pipe be kept at about 80 cm (2'-9") and shall not be less than 75 cm (2'-6") except due to special reasons the Consultants directs in writing to the contrary. The maximum depth of trench shall be taken as shown under

|||||

For pipes up to 50 mm dia	For pipes over 75 mm (3") dia
Including 38 mm to 75 mm (2" to 3")	75 mm (3") dia
50 cm Depth	60 cm Depth
(20")	(22") (24")

2.6 FLANGES

Flanged joints shall be provided at intervals of not more than 152m (500 Ft.). Each flanged joint shall be made by inserting an accurately cut disc of tough multiply rubber insertion about 3.2 mm (1/8") thick of approved quality between the flanges. The bolt holes in the rubber insert as well as in the flanges shall be drilled to template, the bolts and nuts for all flanged joints shall consist of British Standard mild steel, hexagonal, round and hexagonal. The bolts shall be pulled up gradually and evenly by the use of standard spanners, so as to ensure a perfect joint.

2.7 BENDS, TEES AND OTHER SPECIALS

Bends, tees and reducers and other specials shall be provided and jointed at points as shown on the drawings or as directed by the Consultants. All changes in direction shall be effected by means of bends wherever practicable and the use of elbows shall be restricted only to cases where there is no room for bends. In such cases only round elbows will be allowed.

2.8 TEST

All pipe lines in course of or after laying and jointing but before being covered, shall be tested hydraulically, using a test Pump fitted with accurate pressure gauge to be approved by the Consultants to normal static pressure plus 50 Psi gauge but not less than 150 Psi i.e. All pipes, specials and fittings with their joints shall remain perfectly water tight under the full test head for a period of not less than two hours after .the whole length of the pipe line has been examined and demonstrated to be water tight.

2.9 PIPES ATTACHED TO WALLS OR CEILINGS

a) Provide suitable and substantial hangers and supports for all horizontal and vertical line of approved types and make special vibration eliminating and flexible hanger shall be provided for all pipe work affected by moving machinery or expansion and contraction including building expansion joints.

b) Hot and Cold horizontal piping shall be supported in accordance with the following schedule:
Pipe Size Minimum Hangers Road

	<u>Size</u>	<u>Spacing</u>	
1) 1" and smaller	8 feet - 0 inch		3/8"
2) 1-1/4" -2 inch	9 feet - 0 inch		3/8"
3) 2-1/2 -4" inch	10 feet - 0 inch		1/2"
4) 6" and larger	12 feet - 0 inch		1/2"

c) Hanger shall be supported from approved concrete inserts in concrete slabs for all pipes 2" and above. Insert shall be as approved by the Consultants, and shall have space for nuts of all size. All inserts shall have a reinforcing rod of specified diameter to be installed through slot provided for this purpose, and the Contractor shall be responsible for it's being in place when concrete is poured. The Contractor should place all inserts in pour for all, pipes which are to be hung, in ample time to allow the Contractor for general consideration to perform his work on schedule. If any pipe has to be hung in space where no inserts have been provided, the Contractor shall drill holes from below through concrete slabs and provide rods and hangers attached to not less than two approved type expansion shield each one capable of taking full maximum load. The rods and complete hangers shall be of adequate size to support the load, which they carry.

d) Provided approved roller supports, floor stand wall brackets, masonry, etc. for all lines running above the floors, and which can be properly supported by the floors of walls. Pipelines near walls may also be hung by hangers, carried from approved wall bracket at a higher level than the pipe.

e) No piping shall be hung from the piping of other trades or other piping except for small water branches in toilet where no other practical means of support can be found, in which case specific approval of the installation shall be obtained from the Consultants. Hangers shall not be fastened by means of vertical expansion bolts. Hanger shall be of heavy construction suitable for the size of pipe to be supported. All materials, except roller shall be a malleable iron or steel. Rollers shall be cast iron. Hanger shall be swivel split ring, wrought pipe clamp, or adjustable type or as approved.

f) Special care shall be taken in the placing of hangers at the top, bottom and in offsets of hot water risers, so as to allow for expansion of the vertical piping. Vertical risers shall be securely supported from the building construction by means of pipe clamps at every floor, or as too short to connect to the building construction. -

g) For cast iron hub and spigot pipe and fittings hangers shall be provided on not more than 5 feet centers or a minimum of one hanger per each length of pipe. Where excessive numbers of

fittings are installed between hangers, the Contractor shall provide additional hanger or reinforcing as required and to the satisfaction of Consultants, securely anchor fittings to the building construction changes of direction to eliminate all horizontal movement. The Contractor shall furnish and install steel channels and angles for piping support. These supports will be required at those floors, which are not slabbed over and/or where the building structure is not directly usable for pipe support.

2.10 PIPES SLEEVE

Every pipe line laid through any walls, floors, ceilings or roofs shall be arranged to pass through proper hot dipped galvanized sleeve pipes as approved by the Consultants or ample diameter embedded therein to enable the pipe lines to pass easily and freely. The length of every such sleeve pipe shall be of the full width or thickness of the wall and in the case of roof, ceiling or floor, shall be at least 4 cm (1-1/2") longer than the thickness thereof and shall project to that extent above the upper surface thereof unless the Consultants orders to the contrary.

2.11 DISINFECTION FOR WATER SUPPLY

After the testing of the pipe work has been satisfactorily completed and when approved by the Consultants, the Contractor shall disinfect the pipelines by dispensing chlorine solution through the entire pipe network to obtain minimum chlorine content of 50 mg/liter for a contact period of at least 30 minutes. The procedure and equipment used to introduce, disperse and test the chlorine in the pipe shall be subject to approval by the Consultants.

2.12 MEASUREMENT

The pipe work 150 mm (up to 6" dia) shall be measured in running foot and no separate measurement will be done for tees, bends, elbows, unions and other fittings. Unit of measurement for pipe work shall be taken along the centerline and unit of measurement will be one linear Ft.

2.13 PAYMENT

The rate shall include all cost of material i.e. pipe, fittings, jointing material, lubricant, sleeve pipes, hangers and clamps, and labour of every type and incidentals.

.....End of Section.....

PLUMBING AND SANITATION WORKSECTION-3

3.1 DESCRIPTION

Work under this Section includes supplying and fixing all sanitary works including English type W.C., or Asia type W.C., wash hand basins, urinals, sinks, low down and high level cistern, automatic flushing tank showers, Taps, Valves Also any special fixtures called for on the plans and mentioned in the Bill of Quantities.

3.2 MATERIAL REQUIREMENTS

3.2.1 Plumbing Fixtures and Fittings

1. European type water closet shall be of standard clear opening between flushing rims in white earthenware best quality (local made) "P" or "S" trap 3 gallons (13.5 liters) enameled, wall type flushing tank, enameled flush bend, PVC syphonic type fittings complete with corrosion resistant alloy ball valve of best quality manufacture in Pakistan. Standard seat and cover with PVC rings and nuts and rubber buffers, etc. complete.
2. Asia/Orrisa type water closet of standard clear opening as measured between flushing rims with foot rest in white earthen ware best quality (local made) with back or front flush, specified dia. C.I. trap of the same make, 3gallons (13.5 liters) Ceramic flush tank with syphonic type flush fitting corrosion resistant alloy or plastic ball valve of Asia or equivalent 1-1/4" (31 mm) dia telescopic flush pipe made from PVC pipe of the same size fixed to wall with PVC/C.P. saddle.
3. Wash basin of specified size in white colour earthenware best quality mounted on C.I. brackets fixed to wall, (local made) with 1/2" (15 mm) C.P. pillar cock, 1-1/4" (31 mm) C.P. waste chain plug, local made heavy counter sunk screws, PVC/C.P. down take waste pipe 1/2" (15 mm). PVC/C.P. type cock heavy duty with 1/2" (15 mm) PVC/C.P. inlet connection 1/2" (15 mm) C.P. brass union nuts washers, including 3 coats of approved enamel paint to C.I. brackets.
4. Urinal size 17" (425 mm) in white earthenware best quality (local made) with C.I. automatic flush tank 1/2" (15 mm) C.P. stopcock heavy duty, 1/2" (15 mm) PVC inlet connection with C.P. brass union nuts and washers. The urinals shall be connected with G.I. pipe flushing assembly connected to each urinal and 1-1/2" (38 mm) PVC waste pipe.
5. The shower roses shall be chromium finish universal type with adjustable spray of best quality local made as per approval.
6. The sink shall be of stainless steel best Quality local made with all accessories.

NOTE

C.P. brass waste and union 1-1/2", 1-1/4" (38mm/31mm) dia with PVC/C.P. down pipe to be provided for sinks and wash hand basins.

3.2.2 Showers

The showerhead shall be chromium plated with fountains of size specified in the B.O.Q. or as approved by the Consultants.

Each shower shall be connected through a control valve to the hot and cold mixing valve. This shall be best quality manufactured approval shall be given by the Consultants.

3.2.3 Taps

All taps shall be of heavy-duty type, chromium plated or brass as applicable and be of approved manufacture.

3.3 CONSTRUCTION REQUIREMENTS

3.3.1 Water Closets

The work shall consist of providing and fixing in position Orrisa type water closet or European type water closet of an approved manufacturer. The type pan shall be of white vitreous China, glazed fire, fire clay, or any other approved non-absorbent material with specified diameter trap of the same material and footrest. The surface shall have a glazed finish with minimum of fouling area and a seal depth greater than 50 mm. The outlet shall be placed well hack and the pan shall be sufficiently long to meet the design requirement. The flushing water connection shall be from the rear end.

The European type water closet shall also be of vitreous China made of an approved manufacturer with low level flushing cistern and with double seat cover. The w. C. shall be of syphonic type with large water area and deep seal, the cleaning being effected by syphonic action. It shall have a low trap at the floor line so that the closet cannot be un-trapped by the emptying water.

The flushing cistern shall be of white glazed earthenware 13.6 liters capacity as specified in the BOQ.

The flush pipe shall be plastic PVC or chromium plated steel pipe, the holes for inlet, outlet and overflow in the cistern shall be made watertight by inserting rubber washes or other means of providing a watertight joint. The position of water closet shall be so arranged that it shall not face Qibla.

Every water closet shall be provided with a water supply bib tap for filling the small water cans in the site down position. A chromium plated toilet paper holder close to each water closet shall also be installed.

3.3.2 Sink

Sink shall be of stainless steel of size as specified in the BOQ with self-contained drain boards of approved manufacturers. The sink shall be fitted with rubber plug and washers, 38 mm dia. chromium plated bottle with waste pipe with all necessary accessories for making the sink a complete units. The internal angles shall be of a design to facilitate cleaning with a fall towards outlet to drain the contents completely.

3.3.3 Service Sink:

If required shall be made of stainless steel of 16 gauge as approved by Consultants. The sink shall be used for drawing water for scrubbing and cleaning and to dispose off the contents of scrub buckets and vessels containing slops. The edge of the sink shall be placed about 600 mm above the floor to minimize, lifting and to leave room for the trap beneath.

The water supply and drainage equipment for such sinks shall be similar to that for kitchen sinks, except that no hot water supply or mixer will be installed.

3.3.4 Water Pump

Pumps for Domestic Water, Fire Fighting, Drainage and Sewage Lift Station

The centrifugal pump-motor sets shall be heavy-duty industrial type suitable for continuous and quiet operation.

The centrifugal pumps shall be single stage, small size of vertically split casting and large sizes or horizontally split casing as specified in the Schedule of Equipment.

The pumps to be volute type, cast iron body, fully bronze fitted, bronze impeller of radial type with double curvature vanes, stainless steel shaft or shaft sleeve, properly lubricated bearings, readily accessible stuffing box with packing and seal cage, flanged suction for the pump and the motor and the pump shafts covered with approved guard, pump casing to be complete to be completed with drain and vent plugs and designed, tested and proven tight for a test pressure at least equal to 1.5 times the maximum working pressure.

The pumps to have the gate valves and strainers on the suction side, globe valves on the discharge side and pressure gauges on suction and discharge sides. If pumps are operating in parallel then a check valve to be installed on the discharge side of each pump.

The pumps shall be direct driven by a constant speed motor and provided with a suitable starter. The pump motor HP has been given for each system for guidance but it is intended that motor of higher HP shall be provided if required to ensure that it is not overloaded under any possible operating conditions of the pump.

Each pump shall be guaranteed for circulating the specified water quantity against specified net discharge head under the specified conditions of operation when operating continuously without overheating the motor, bearings, etc. However, the Contractor will check and confirm the actual discharge head required before placing orders for the pumps.

The pump shall be selected for quiet operation so that pump noise is not audible outside the plant room. The pump sound shall not be transmitted to the Building Structure.

The pumps installed for one system should be suitable for parallel operation in all respects. The pump impeller and motor should be so selected that these are not overloaded when only one pump is operating and increased water flow is to be handled due to reduced system head.

The Contractor shall supply anti-vibration foundation material (both pads for isolator of main foundation and spring mountings for inertia mass) for isolating the pump foundations from the Building structure.

The number, size and conditions of operation for pumps required for different systems are specified in the Schedule of Equipment and the pumps location shown in the drawings.

Certified performance data and curves shall be submitted by the CONTRACTOR for approval to confirming the purchase order on the manufacturer/supplier.

All pumps to be supplied under this section to be of one manufacturer for the same type.

The pump motor sets to be of local manufacture, KSB or approved equal, for the sizes manufactured locally.

- a) Pump capacity in US gpm against net discharge head, RPM, HP of motor, and pump maximum HP requirement.
- b) Construction and other technical details.
- c) Overall dimensions and operating weight.
- d) Manufacturer's performance guarantee certificate and performance data and curves and technical bulletin.

The sewage ejector submersible centrifugal pump motor sets shall be vertical heavy duty Industrial type with non-clogging impeller suitable for continuous operation.

The pump capacity rating shall be as specified in the Schedule of Equipment.

The pump shall be vertical ~ngle entry single stage non self-priming. The pump casting shall be radially split open towards the discharge end sealed off by a cover, suction end with a renewable wear plate and nozzle, impeller suitable for mixture of contaminated fluids, solid particles and sludge. The shaft length shall suit the installation depth shown in the drawings and shaft pieces joined together by threaded shaft coupling. The weight of the rotor and axial thrust will be absorbed. by deep groove ball bearing in the vertical hollow shaft motor. A grease pump mounted on the pump mounting plate shall continuously feed grease individually to every hearing during pump operation. The pump shall be fitted with soft packed stuffing box fed with sealing grease; the pump base plate shall be sized large enough to enable the pump to be pulled out/lowered into the pit without the necessity of enlarged pit roof opening. The pump discharge line will be terminated above the base plate. The wear plate shall be of cast iron, shaft-protecting sleeve of stainless steel, shaft of carbon steel, base plate of steel, motor stool of steel/cast iron and bearing of lead bronze.

The pump motor sets to be of local manufacture, KSB type KVP or approved equal.

The Tenderer to give following information for the pump:

- a) Pump capacity in US gpm against specified head, RPM, pump maximum BHP requirement and motor HP.
- b) Construction and other technical details.
- c) Overall dimensions and operating weight, clear height required above base plate for pulling out the pump.
- d) Manufacturers Performance Guarantee Certificate and performance data and curves and technical bulletin.

Level controllers

Each group of the above pumps shall have a control system as detailed below:

A three position level controller shall automatically control the pump operation. The level controller shall start the pump at high level and stop the same at low level. A highest level, the level controller shall energize an audio-video alarm.

3.3.5 Unions

Provide accessible unions in supply and return connections at all equipment fixtures, fixtures, specialists automatic valves, screwed end valves and at all other points ill the system where required, in order to facilitate removal of specialties or equipment for repairs.

3.3.6 Expansion Joints For C.I Soil or waste pipe

Expansion joint in C.I. soil or waste pipe shall be provided as pre plans, where the pipe crosses building expansion joint. These will be of non-pressure type, similar to imported Jossam Series.

3.4 MEASUREMENT

Measurements shall be made for the number of fixtures and toilet accessories acceptably provided and fixed in position.

3.5 PAYMENT

Payment shall be made for the number measured as provided above at the contract unit rate for the respective items in the Bill of Quantities and shall constitute full compensation for all labour material, use of equipment and tools required for work related to the item including providing and fixing all other work to complete the item in al respects as specified or as directed by the Consultants.

.....End of Section.....

SECTION-4SEWERAGE/DRAINAGE WORK

4.1 DESCRIPTION

4.1.1 Sewerage

All sewerage/drainage pipes work inside the houses and buildings and up to the connection of the trunk sewer shall be covered under this section. The pipes shall be M/S DADEX, RCC or C.I. as specified including soil, waste, vent and anti-syphonic pipes.

4.2 MATERIAL REQUIREMENTS

All RCC/C.I. pipes shall conform to the specifications referred to in Section "Materials" and as specified in this section.

For Cast Iron Pipes, the joints shall be lead caulked. The packing material shall be pure jute, hemp or hemp yam.

For M/S DADEX, all activities should be in accordance with the manufacturer's specifications.

For RCC pipes the cement mortar to be used on joints shall be of 1: 1 ratio or as per Plans. Material specifications for sewerage and drainage shall be as follows: -

a) Cast Iron Pipe, socket and spigot (6' length)

Minimum Weights

Dia (in)	2	3	4	6
Weight (Lb.)	24.90	37.00	48.00	
	72.90			

Test Pressure against leakage = 20 Psi.

b) Cast Iron Fittings

Minimum Weights (lb.)

TABLE-I (BENDS)

Fittings (Inches)	2	3	4	6
87-1/2 degree and 45 degree Bend with out access	6.3	11	15	24.9
87-1/2 degree and 45 degree bend with access	7	11.9	18	29.9

TABLE (WYES & REDUCERS)

Fittings (inches)	2x2	2x3	3x3	2x4	3x4	4x4
87-1/2 degree and 45 degree without access	9	15	16	17	20	24
87 -1/2 degree and 45 degree Wye with access	11	16	18	20	24	26
Eccentric Reducer with smaller side socketted	-	7.9	-	11	11	-

c) R.C.C Pipe

BSS 556 : Class –M < 9"

6"-dia pipe with collar
9" pipe, spigot and socket
ASTM C76- 72-a > 12"

4.2.1 Cast Iron Floor Trap Manhole Frames and Cover Grating

These shall be cast from a mixture of cast iron scrap and suitable grade of pig-iron, and resultant metal shall be of strong gray structure, free from chips, air bubbles and sand holes and shall be smooth and even both inside and outside.

4.2.2 Grease Trap

Grease Trap shall be made of cast iron, for specified flow capacity and inlet/outlet dia and provided where shown on plans. Grease trap shall be embedded in raised floor and inlet shall be submerged.

4.2.3 Glazed Earthen Ware

Shall be of best and approved quality and the water seal shall not be less than 63.5 mm (2-1/2") deep.

4.3 CONSTRUCTION REQUIREMENTS

4.3.1 Laying of Pipe

Pipes and accessories shall be carefully examined before being laid and defective damaged pipes shall not be used. The pipes shall be brushed clean inside and outside to remove any soil or foreign matter that may have accumulated, including inside of the sockets and outside of spigots, before being lowered into the trench, and shall be kept clean during laying operation by plugging or other approved method.

The bottom of the trench shall be shaped to give substantially uniform circumferential support to the lower fourth of each pipe. Pipe laying shall processed upgrade with the spigot ends of bell and spigot pipe pointing in the direction of flow. Each pipe shall be laid true to line and grade and in such manner as to form close concentric joint with the adjoining pipe. If the width of the trench at

the pipe is exceeded than necessary, due to any reason other than under direction from Consultants, the Contractor shall install at

no additional cost to the Owner, such concrete cradling pipe encasement or other bedding as may be required to satisfactorily support the added load of the backfill.

Trenches shall be kept free from water until the jointing material has set, and pipe shall not be laid when the condition of the trench or the weather condition is unsuitable for such work. At times when work is not in progress, open ends of pipe and fittings shall be securely and satisfactorily closed so that no trench Water, earth, or other substance will enter the pipe and fittings.

As the work progresses, the interior of the sewer shall be cleaned of all dirt and superfluous materials of every description. Where cleaning after laying is difficult because of small pipe size, a suitable swab or drag shall be kept in the pipe and pulled forward past each joint immediately after the jointing has been completed.

Where sewers cross above water line the sewer pipe for a distance of 3 meter (10 feet) each side of the crossing shall be of cast iron steel or other acceptable pressure pipe and with no joint closer than 3 feet (900 mm) to the crossing, or shall be fully encased in concrete of nun. 15cm. (6") thickness.

Any section of the pipe found to be defective before and after laying, shall be replaced with sound pipe without additional expense to the Owner. .

The jointing of pipes with collars shall be done first with spun yarn rope (dipped in hot maxphalt composition) fitted in between the ends of pipes and pressed together. The dia of rope shall not exceed 19mm (3/4") or as directed by Consultants.

The collar shall then be brought in the middle of the joint. Wooden wedges shall be placed at two or three places around the pipe so that the collar may have uniform gap all round the pipe for pressing pipes together. At a time five or six pipes shall be jointed together. After putting bitumen soaked hemp rope, suitable jacks and wedges or any other approved method shall be used. The inside of the collar and outside portion of the pipe shall be cleaned with brush and cement mortar of 1: 1 proportion shall then be inserted from both ends of the collar. The mortar containing as little quantity of water as possible shall be carefully inserted by hand into the joints and tightly pressed with caulking tool. The mortar shall be finished off on the outside at an angle of 45 degree. The wooden wedges shall be carefully removed and mortar filled in the cavity before finishing. The joints shall be protected from weather and maintained wet for at least ten days and shall not be covered with backfill until the joints have been tested and approval given by the Consultantss.

For jointing of pipes with spigot and socket joints, the first pipe shall be bedded with the socket end upstream. The interior surface of the socket shall be carefully cleaned with a wet brush and its lower portion filled with mortar to such a depth as to bring together the inner surfaces of the abutting pipes flush and even. All further joints shall be made in this manner. The remainder of the socket joint shall be filled in with mortar and well pressed with the help of caulking tool. The mortar shall be finished smooth on the outside at an angle of 85 degree. The joints shall be protected and cured as for collar joints.

4.4 FLOOR TRAPS

Floor traps with gratings shall be made of high grade, strong, tough, and even grained metals. Castings shall be free from blowholes porosity, hard spots, excessive shrinkage cracks, or other defects, shall be smooth and well cleaned both inside and outside. Castings shall not be repaired, plugged, brazed, or burned. The wall thickness of iron casting shall be not less than 6.4 mm (1/4")

Joints for Cast Iron soil, waste and vent pipes shall be made with lead, jute, hemp or hempen spun yam. The packing material shall be well placed into the annular space so as to prevent the entrance of lead into the pipe. Run lead joints shall be applied to perfectly dry pipes. Under wet condition lead fibre joints shall

be made both with quantities and depth of jointing materials and by method as per B.S. Code C.P. 301 (1950). The remainder of the space shall be filled with molten lead that is hot enough to show a rapid change in colour when stirred. The lead shall be caulked to form a tight joint without over straining the hell.

4.5 TESTING OF PIPELINES

No work shall be covered over or surrounded with concrete until it has been inspected, tested and approved by the Consultants.

4.6 DRAINAGE PIPES

The test shall be applied before the pipes are haunched with concrete or covered in and repeated after back filling the trench. Water test shall be carried out in drainage lines of RCC and the section of a test pressure of head of water equal to M.H. depth by suitably plugging the lower end and filling the system with water.

The test pressure shall be maintained for 30 minutes without showing a drop of more than 7.5 cm. (3").

In RCC pipelines water should be added until absorption by pipes and joints has ceased. A slight amount of sweating which is uniform may be over-looked but excessive. Sweating in a particular part or joint shall be taken as a defect. Any leakage visible shall indicate defective work which shall be, cut out and made good by replacement by the Contractor at his own cost and re-tested for acceptance.

Air test may be employed if allowed by the Consultants where an adequate supply of suitably plugged and air pumped until a pressure of 100 mm (4") of water is indicated in a glass U-tube connected to the system. Without further pumping the pressure should not fall below 75 mm (3") during a period of 5 minutes.

After testing the pipe lines as specified the interior of pipelines shall be inspected to ascertain that the pipes are entirely clear of obstruction and that the invert is smooth. For pipes less than 75 mm (3") in diameter, a loose plug shall be passed through each pipeline to ensure that the pipes are entirely clear of obstruction and that the invert is smooth. The loose plug shall be in the form of a cylinder with solid ends made of timber not less than 2.5 cm (1") in thickness, or by any other method as approved by the Consultants.

RCC pipes below 300 mm dia shall conform to B.S. Class- A and dia 300 mm or above to ASTM C 76- 72-a.

4.7 SAMPLES

Samples of all materials shall be got approved before use from the Consultants. Manufacturer's test certificate shall be submitted to the Consultants stating that the pipes conform to the specified grade/ test pressure.

Material may further be got tested, if required by the Consultants at Contractor's cost. Rejected materials shall be removed from the Site of Works immediately and same type of material as approved shall be used throughout the works.

4.8 MEASUREMENT

All pipe work shall be measured in running foot of finished length. No wastage or length consumed in joints shall be measured for payment. Sockets, spigot and RCC collars shall not be measured separately.

For cast iron pipeline the length consumed in valves, fittings and specials shall be measured along with pipeline.

Cast Iron specials and fittings such as Tees, Tapers, Bends, Shoes, Crosses, Offsets, flanged sockets and spigot, plugs and caps etc. shall be measured along with the pipeline,

4.10 PAYMENT

The rate for all items under this section shall cover the cost of all materials, labour, tools, equipment and appliance and performing all operations for laying, fixing and jointing and all work as specified in accordance with drawings, bill of Quantities and as directed by the Consultants.

Rate for pipe work shall also include making and repairing cut holes and chases in walls, floors and slabs etc. painting pipes, supports and accessories cleaning and clearing pipe lines and testing till approved by the Consultants.

SECTION- 5CONSTRUCTION OF MANHOLE

5.1 DESCRIPTION

The work consists of constructing manholes for sewerage of positions shown on the plans or where otherwise directed by the Consultants and in accordance with the detailed drawings supplied from time to time, complete in all respects.

5.2 MATERIAL REQUIREMENTS

Brick masonry, Portland cement, concrete and other materials shall meet the specified requirement of the relevant sections of the specifications for ROC given Section-S "Portland Cement Concrete". Manhole steps shall be of mild steel as shown on the drawings.

5.3 CONSTRUCTION REQUIREMENTS

Manholes shall be constructed with brick masonry of specified wall thickness laid in 1: 4 sand cement mortar built in concrete slab. The cover slab shall be Class-C reinforced cement concrete, fitted with cast iron frame, which shall have weight/2cwt, 18" (450 mm) diameter cast iron cover as shown in the plan. The inside of the walls shall be plastered with 1 :4 sand cement mortar. At the bottom of manholes for sewers proper channel as per drawings, shall be constructed in the whole length of the manhole along the centerline of the sewers, to lead the sewage from one sewer to the other. Mild Steel bar steps shall be installed inside the manhole, during the construction of the manhole walls. Cutting holes into the wall for the steps after construction will not be permitted. Top rung shall be 18" (450 mm) below the manhole cover and the lowest not more than 12" (300 mm) above the benching (Floor). Manholes shall have cement concrete Class-C-1 benching as per drawings/specs. Manholes shall be connected with the nearby sewerage manholes through a reinforced cement concrete pipe as per details provided. Manholes along the central and primary drains shall also act as over-flow structures. The existing over-flow pipes shall be securely connected with these manholes.

5.4 MEASUREMENT

Measurement shall be made for the actual number of manholes as shown in BOQs of the appropriate type constructed at site as per drawings and specifications laid down in this section and to the approval of the Consultants.

5.5 PAYMENT

The unit rate quoted in the priced Bill of Quantities for the construction of manholes shall be considered all compensation to cover the cost of all materials including framework and concrete, brick masonry, excavation, backfilling, steps frame and cover, and connecting pipe with the manhole, and all labour including curing, plastering, trenching, etc. and all incidentals to completely construct them at site, as per drawings and specifications laid down in this section.

.....End of Section.....

SECTION- 6 EXCAVATION FOR WATER SUPPLY LINES AND APPURTENANCES

6.1 DESCRIPTION

The work covered by this section of the specifications consists of furnishing all plant, labour, equipment, appliances, and materials and performing all operations in connection with excavation, trenching and back filling for water lines and appurtenances in strict accordance with this section of the specifications and the applicable drawings, and subject to the terms and conditions of the contract.

6.2 CLEARING AND GRUBBING

The sites of all excavations shall be cleared of all shrubs, plants, hushes, large roots, rubbish and other surface materials. All such materials shall be removed and disposed off in a manner satisfactory to the Consultants. All trees and shrubbery that are designated by the Consultants to remain shall be adequately protected and preserved in an approved manner .

6.3 EXCAVATION

6.3.1 General

All excavation of whatever substance encountered shall be performed to the depths indicated or as otherwise specified. During excavation, material suitable for backfilling shall be stockpiled in an orderly manner at a sufficient distance from the banks, of the excavation to avoid overloading and to prevent sides from caving. Alf excavated material unsuitable or not required for backfill shall be removed and wasted at a location approved by the Consultants. Excavation in the streets shall be done in such a manner that street passage is not blocked by excavated material. Grading shall be done as may be necessary to prevent surface water from flowing into trenches or other excavations, and any water accumulated therein shall be removed by pumping or by other approved methods. Unless, otherwise indicated or approved by the Consultants, excavation shall be open cut.

6.3.2 Trench Excavation

Unless otherwise directed or permitted by the Consultants not more than 500 ft. of any trench in advance of the end of the pipeline already laid shall be opened at any time, unless otherwise directed or permitted by the Consultants not more than 1000 ft. of any trench shall be worked on at a time from removal of pavement bottom, not exceeding 5 feet in depth shall be a maximum of 20 inches plus the external diameter of the pipe barrel and the width of the trench exceeding 5 feet. in depth shall be maximum 30" plus external diameter of the pipe barrel; The banks of the pipe trench shall be as nearly vertical as practicable. Bell holes. and depressions for joints shall be dug after the trench bottom has been prepared. The pipe-, except for joints, shall rest on the prepared bottom for its full length. Bell holes and depressions shall be only of such length, depth, and width as required for properly making the particular type of joints, Stones shall be removed to avoid point bearing. Whenever wet or otherwise unstable material that is incapable of properly supporting the pipe as determined by the Consultants is encountered in the bottom of the trench, such material shall be removed to the depth required and the trench backfilled to the proper grade with coarse sand, or other suitable approved granular material. Such replacement of unsuitable material shall be paid for at the contract unit price for that item of work.

Trenches shall be of a depth to provide a maximum cover, over the top of the pipe, of 30" from the existing ground surface or finished grade whichever is closer except that trenches for pipe laid in lanes and alleys of narrow traveled way (average width of 8 feet or less between structures) shall be of a depth to provide a minimum cover, over the top of the pipe, of 18" from the existing ground surface or finished grade whichever is closer.

6.3.3 Excavation for Appurtenances

Excavation for appurtenances shall be sufficient to leave at least 12" but not more than 24" between the outer surface and the embalmment or timber that maybe used to hold and protect the banks. Any over-depth excavation below such appurtenances that has not been directed by the Consultants will be considered unauthorized and shall be refilled with compacted sand, gravel or concrete, as directed by the Consultants at no additional cost to the Owner.

6.3.4 Maintenance of Excavation

All excavation shall be properly maintained while they are open and exposed. Sufficient suitable barricades, warning lights, floodlights, signs, and similar items shall be provided by the Contractor. The Contractor shall be responsible for any damage due to this negligence.

6.3.5 Removal of Water

The Contractor shall build all drains and do ditching, pumping, well pointing, hailing, and all other work necessary to keep the excavation clear of ground water, sewage and storm water during the progress of the work and until the finished work is safe from injury. All water pumped or drained from the work shall be disposed of in a manner satisfactory to the Consultants and necessary precautions against flooding shall be taken.

6.3.6 Sheeting and Bracing

If ordinary open-cut excavation is not possible or advisable, sheeting and bracing shall be finished to the work and to provide working conditions, which are safe. The Contractor shall furnish and place all sheeting, shorting, wail braces, timbers and similar items, necessary for the safety of the work, the general public and adjacent property. Sheeting, shoring and bracing shall be removed as the working progresses arid in such a manner as to prevent damage to finished work and adjacent structures and property. As soon as withdrawn, all voids left by the sheeting and bracing shall be carefully filled with sand and compacted. The Contractor shall be fully responsible for the safety of work in progress, for the finished work, the workmen, the public and adjacent property.

6.3.7 Protection of Facilities

Existing subsurface facilities likely to be encountered during the execution of work require special precaution for the protection, such as sewers, drain pipes, water main, conduits and electric cables and the foundations of adjacent structures. The Contractor shall be responsible for the damage of any such facility and shall repair the same at his expense whether or not this facility has been shown on the drawings.

6.3.8 Surplus Materials

All surplus materials shall be disposed of at locations approved by the Consultants. Disposal of surplus material shall not interfere with other works and shall not damage or spoil other material. When it is necessary to haul earth or the material over street or pavement, the Contractor shall prevent such material from filling on the street or pavement.

6.3.9 Cutting Pavement

In cutting or breaking street surfacing, the contractor shall not use equipment, which will damage the adjacent pavement. Existing paved surfaces shall be cut back beyond the edges of the trenches to form neat square cuts. The road ballast brick pavement, and other materials shall be placed on one side and shall be preserved for re-installment when the trench is filled. Wherever necessary or required for the convenience of the public or individual residents, at street crossings and at private driveways, the Contractor shall provide suitable temporary bridges over unfilled excavations. All such bridges shall be maintained in service until backfilling has been completed. The Contractor shall keep the road crossings manned 24 hours per day. During nighttime, enough red lights shall be provided to warn traffic. If a detour is necessary, the Contractor shall make proper detour for the traffic and shall install signs 3 feet by 4 feet in size indicating the detour.

6.4 BACKFILLING

The trenches shall not be completely backfilled until all required pressure tests are performed and until the water lines as installed conform to the requirements of specifications. Where in the opinion of the Consultants, damage is likely to result from withdrawing sheeting, shoring, the same shall be left in place and cut off at a level 12" below ground surface. Shoring left in place at the direction of the Consultants will be paid for at the contract unit price/approved rate for that item of work. Trenches shall be backfilled to the ground surface with selected excavated material or other material that is suitable for proper compaction. Trenches improperly backfilled shall be reopened to the depth required for proper compaction, then refilled and compacted to the specified density. The surface shall be restored to its original or better condition. Pavement and base course disturbed by trenching operations shall be required.

6.4.1 Lower Portion of Trench

Backfill material shall be deposited in 5" maximum thickness layers and compacted with suitable hand tampers to ninety-five percent of maximum density until there is a cover of not less than 12" over the water lines. The backfill material in this portion of trench shall consist of sandy clay or other approved materials free from stones and lumps.

6.4.2 Remaining of Trench

The remainder of the trench shall be backfilled with material that is free from stones larger than 5" in any dimension. Backfill material shall be compacted to 90 percent of maximum density for cohesive soils and 95 percent of maximum density for others.

6.5 BORROW

Where suitable material for backfill is not available in sufficient quantity from required excavations, suitable material shall be obtained from approved sources at the contractor's responsibility. The necessary clearing and grubbing or borrow areas, disposal and burning of debris therefrom, the developing of sources including any access roads for hauling and the necessary right-of-way, and the satisfactory drainage of the borrow shall be considered as incidental items to be borrow excavation.

6.6 GRADING

After completion of all backfilling operations, the Contractor shall grade the work areas to be lines, grades and elevation shown on the drawings. Finished grading shall not be done until the installation of all water lines has been completed and tested. The top surface after completion shall be in level to the adjacent existing surface. Prior to final acceptance, all damage due to settlement shall be repaired by and at the expense of the Contractor.

6.7 TESTING DENSITY OF SOIL IN PLACE

The Consultants may make tests using the calibrated sand cone method/core cutter method to determine the density of soil in place. If soil in place fails to meet the specified degree of compaction the areas represented by the failing tests shall be removed, replaced and compacted to the specified density in the manner directed by the Consultants and at no additional cost to the Owner.

6.8 MEASUREMENT

The measurement shall be made for the actual quantity of the work done in cubic feet. The maximum width of the trenches allowed for payment for various pipe sizes will be as under:

- | | | |
|----|------|---|
| a) | Upto | 2" diameter pipe, the trench width will be 15" |
| b) | Upto | 3" diameter pipe the trench width will be 18" |
| c) | Upto | 4" diameter pipe the trench width will be 18" |
| d) | Upto | 6" diameter pipe the trench width will be 21" |
| e) | Upto | 8" diameter pipe the trench width will be 24" |
| f) | Upto | 10" diameter pipe the trench width will be 26" |
| g) | Upto | 12" diameter pipe the trench width will be 28" |
| h) | Upto | 16" diameter pipe, the trench width will be 32" |

6.9 RATE

The unit rate tendered in the priced Bill, of Quantities for excavation of trenches for water supply lines shall be considered as full compensation for the work specified in this section and shall include constructing and removing of all temporary arrangements, backfilling pumping, sand filling under pipes and dewatering, removal of soft soil from bottom of trenches, removing the surface material and all incidentals to complete this work.

6.10 PAYMENT

Payment shall be made for this item of work at the unit rate quoted in the priced Bill of Quantities for.

.....End of Section.....

SECTION- 7 EARTH WORK FOR SEWERS

7.1 DESCRIPTION

Work under this section shall consist of furnishing all materials, equipment and labour for excavation, trenching and backfilling for sewers, drainage facilities, structures and all other appurtenances of sewage collection system, in accordance with drawings to proper line and grade refilling the trenches and dressing them to proper surface.

7.2 CLEARING AND GRUBBING

The sites of all excavations shall be cleared of all shrubs, plants, bushes, large roots, rubbish and other surface materials. All such materials shall be removed and disposed of in a manner, satisfactory to the Consultants, all trees and shrubbery that are designated by the preserved in an approved manner.

7.3 EXCAVATION

7.3.1 General

The Contractor shall do all excavation of whatever substance encountered to the depth shown on the drawings or as otherwise specified. Excavation shall include without classification the removal and disposal of all material of whatever nature that would interfere with the proper construction and compaction of the work and shall include the furnishing, placing and maintenance of supports for the sides of the excavations. The work shall also include all pumping, ditching, dewatering and other measures required for the removal and exclusion of water. During excavation, material suitable for backfilling shall be stockpiled in an orderly manner at a sufficient distance from the bank of the excavation to avoid over-loading and to prevent sides from caving. Topsoil should be stockpiled separately for subsequent reuse as necessary. All excavated material unsuitable or not required for backfilling shall be removed and disposed of at a location approved by the Consultants,

For contract purposes hereunder, the earth excavation work has been classified into two categories, earth excavation in trenches and earth excavation for structures.

7.3.2 Earth Excavation in Trenches

Except as otherwise provided herein, excavation for a sewer line shall be open cut trenches with 1 vertical side and not more than 150 feet of any trench in advance of the end of the built sewer shall lie, be opened at any time and unless written permission to the Contractor is given by the Consultants. II The trench shall be excavated to its full depth for a distance permitted for the sewer to be laid. Trenches for sewer-lines and appurtenances shall be to the lines and grades shown on the drawing ".,," or as ordered in writing by the Consultants as necessary for the proper completion of the work, Bell holes and depressions for Joints shall be dug after the trench bottom has been graded. The pipe except for joints shall rest on the prepared bottom for its full length. Belt holes and depressions,"" shall be only of such length, depth and width as required for properly making the particular type of joint. Stones shall be removed to avoid point bearing.

Where the bottom of the excavation is in material which in the judgment of the Consultants by reason of its hardness cannot be excavated to provide a uniform bearing for the pipe, said material shall be removed to minimum of 6 inches below the grade of the bottom of the pipe, and the trench backfilled to the required pipe sub grade with river sand or other material acceptable to the required depth with concrete grade if so ordered. In no case material removed from such

excavation shall be used as backfill material unless approved by the Consultants. All instruction shall be in writing by the Consultants.

7.3.3 Earth Excavation for Structures

All earth excavation under this contract, which is not included under the classification of "Earth Excavation in Trenches" shall be classified and paid for as earth excavation for structures.

The Contractor shall provide adequate timbering or shoring for excavations. Should the sides and ends of an) excavations give way the contractor shall, at no extra cost, remove all disturbed ground. Any excavation carried outside the limits shown or drawings and specified herein as the payment limits, shall not be treated as excavation and shall not be paid for.

When foundation level is reached, the Consultants representative will inspect the exposed ground and give directions as to what further excavation, if any, he considers necessary. The excavation should be done in such a manner, as to ensure that the work rests in a solid and perfectly clean foundations. If the Contractor allows any portion of such foundations to deteriorate due to exposure, he shall make good the foundation to the satisfaction of the Consultants without extra cost.

7.3.4 Alignment and Grade

The sewers are to be laid to the alignment and gradient shown on the drawings, but subject to such Modifications as shall be ordered by the Consultants from time to time to meet the requirements of the works. No deviations from the lines, depths of cutting or gradients of the sewers shown on the drawings and sections shall be permitted except by express directions in writing of the Consultants.

7.3.5 Setting of Sight Rails

The sewers shall be constructed and laid to a true grade and in straight lines between curves as shown on the plan. The sewer shall be laid and constructed to their proper levels with the aid of suitable boning rods and sight rails which shall be fixed according to the requirements of the Consultants at intervals not exceeding 10 feet and also by leveling along the invert with leveling instruments, The sight rails and boning rods shall be provided, fixed and maintained by the Contractor who shall also provide and maintain suitable leveling instruments and equipment and shall set the positions and levels of the sewers and other work according to the drawings and any instructions which he may receive from the Consultants, all sight rails and posts shall be well seasoned deodar timber or ample size and strength. The rails and honing rods shall be suitably and accurately planned and no warped or otherwise defective or damaged sight rails or boning rods shall be used. Sight rails shall be secured to the posts by strong steel clamps to the approval of the Consultants and in such a manner that they shall be fixed as immovable, in relation to the correct liens and levels. All boning rods and sight rails shall have the center line accurately marked thereon by a fine saw cut and shall be painted black and white to the requirements of the Consultants. All honing rods shall suitably be showed with iron. At least four separate sight rails shaft always be maintained in correct level and alignment along the line of sewer at every place where construction work is proceeding and the alignment and level of the sight rails shall be checked by the level and line at least twice every day to ensure that no disturbance or interference of the alignment and level have taken place. Whenever required the Contractor shall erect and maintain such additional sight rails as the Consultants shall direct. The Contractor shall, at all times, see that his workmen or other unauthorized persons are not allowed, accidentally or otherwise, to tamper or interfere with sight rails or other alignment or level marks.

All bends and curves shall be set out mathematically in a manner or approved by the Consultants and the Contractor shall provide and maintain for the purpose such additional sight rail posts and other

wrought and rough timber work, steel wire and other articles as the Consultants shall require from time to time.

7.3.5 Sheeting and Bracing

If ordinary open-cut excavation is not possible or advisable, sheeting and bracing shall be furnished and installed in excavations to prevent damage and delay to the work and to provide working conditions which are safe. The Contractor shall furnish and place all shoring, sheeting, walls braces, timbers and similar items necessary for the safety of work, the general public and adjacent property. Sheeting, shoring and wall bracing shall be removed as the work progresses and in such manner as to prevent damage to the finished work and adjacent structures and Property. As soon as it is withdrawn all voids left by the sheeting and bracing shall be carefully filled with selected material and compacted. The Contractor shall be fully responsible for the safety of work in progress, for all work, the workmen, the public expenses, as part of the work under the excavation items and at no extra cost.

7.3.7 Dewatering of Trenches

As part of the work under the excavation items and at no extra cost, the Contractor shall build drains and do ditching, pumping, well-pointing, hauling and all other work necessary to keep the excavation clear of ground water, sewage and storm water during the progress of the work and until the finished work is safe from injury, the Contractor shall provide all necessary pumping equipment for the dewatering work, as well as operating personnel, maintenance, power etc. all at no extra cost. All water pumped or drained from the work shall be disposed of in a manner satisfactory to the Consultants. Necessary precautions against flooding shall be taken.

7.3.8 Maintenance of Excavations

All excavation made hereunder shall be properly maintained while these are open and exposed. Sufficient suitable barricades, warning lights, signs and similar items shall be provided by the Contractor. The Contractor shall be responsible for any personal injury or property damage due to his negligence.

7.3.9 Protection of Existing Facilities

The Contractor shall take special care of existing subsurface facilities likely to be encountered during the excavation for their protection, such as sewers, drain pipes water main conduits, electric cables, communication cables and the foundations of adjacent structures. The Contractor shall be responsible for any damage to any such facility and shall repair the same at his expense whether or not the facility has been shown on the drawing.

7.3.10 Disposal of Surplus Excavated Material

All surplus material excavated by the Contractor shall be disposed of at locations approved by the Consultants. The disposal of surplus material shall not interfere with other works and shall not damage or spoil other materials. When it is necessary to haul earth material over streets or pavements, the Contractor shall prevent such material from falling on the streets or pavements.

7.4 BACKFILLING

7.4.1 General

After the completion of sewer line, drainage facilities foundations, walls and other structures below the elevation of the final grade all voids shall be backfilled with suitable materials specified below.

7.4.2 Backfilling for Structures

Backfilling operations for structures shall be performed as part of the Contractor's work under the payment items for earth excavation and at no extra cost. Backfilling material for foundations, walls and other structures shall consist of excavated soil, which is free from stones and hard clods not larger than 3 inches in any dimension, and also free from trash, lumber and other debris. Backfill material shall have enough moisture for proper compaction and shall be compacted in an approved manner to 90 percent of maximum density for cohesive soils and 95 percent of maximum density for cohesion-less soils. Backfill shall not be placed against foundation walls earlier than 4 days after placing of concrete or brick masonry.

7.4.3 Backfilling for Trenches

After the sewers have been constructed and proved to be water tight as per direction of the Consultants the trench shall be backfilled. Utmost care shall be taken in doing this so that no damage shall be caused to the sewer and other underground utilities. After this has been laid the trench and other excavation shall be backfilled carefully in 6" levels with earth as approved by the Consultants, each layer being watered to assist in the compaction unless the Consultants shall otherwise direct.

7.5 MAXIMUM DENSITY DETERMINATION FOR COMPACTED SOIL

The maximum density of the soil shall be determined in accordance with the latest revision of American Society for Testing Materials (ASTM) Standard D-1556 Density Relations of Soils, using 15 lbs. Rammer and 18 inches Drop.

7.5.1 Testing Density of Soil

The Consultants may make tests using the calibrated sand cone method/core cutter method to determine the density of soil in place in accordance with ASTM Designation D 2558, latest revision. If soil in place fails to meet the specified degree of compaction the areas represented by the failing tests shall be re-excavated and compacted to the specified density in the manner directed by the Consultants at no extra cost.

7.5.2 Top Soil

Topsoil which has been stockpiled during excavation shall be used for the top 6" of backfill, in locations as ordered by the Consultants. Topsoil shall be saturated with water and after it has dried, shall be spread to the required final grade and of required density. The work shall be performed at no extra cost.

7.5.3 Proximity to Buildings

Where buildings in the opinion of the Consultants near excavation are likely to be affected, the Contractor shall provide proper shoring to protect such buildings in addition to timbering of trenches. The Contractor shall be required to leave timbering inside trenches if so required by the Consultants for protection of these buildings at no extra cost.

7.6 LENGTH OF TRENCHES IN ADVANCE OF CONSTRUCTION

Unless otherwise directed in writing by the Consultants of the work not more than 200 feet in advance of constructed or laid sewer shall be left open at any time. The trench shall, however, be excavated to full width to minimum length of 16 feet in advance of the constructed laid sewer unless otherwise directed by the Consultants.

7.7 DISPOSAL OF FILTH AND GARBAGE

No night soil filth and garbage met with during the excavation shall be allowed to be deposited on side of road/street so as to cause nuisance or obstruction to traffic. The same shall be disposed of by the Contractor a place to the satisfaction of the Consultants.

7.8 DISPOSAL OF SURPLUS EARTH

The Contractor shall dispose of all surplus excavated materials not required to be used on the work. This shall include surplus earth after refilling and compaction.

7.9 TUNNELLING

7.9.1 Formation of Soil

Tunneling shall only be permitted in strong hard and homogeneous, clay formation which are not likely to collapse under normal working conditions. The work shall not be permitted in running sand. In weaker formation such as mixture of clay and sand which are liable to collapse when exposed to atmosphere. The roof shall be protected by adequate timbering and shoring of roof and the walls, irrespective of any type of alluvial strata. If the tunnel is subject to any sort of traffic, it shall be provided with adequate timbering and shoring for its roof and walls.

7.9.2 Length of Tunnel

Normally the length of tunnel without adequate support shall not exceed 3'. This length shall, however, may be exceeded under the directions of the Consultants, where depth of tunnel below ground level is considerable to avoid any danger of collapse. The tunnel, however, shall be driven in longer lengths up to 150 feet, if drive casing is provided as the tunnel is being excavated.

7.9.3 Horizontal Boring Machines

When considered necessary by the Consultants, horizontal-boring machines shall be employed for crossing sewers underneath highways and canals. Whenever such machinery is used, drive casing of steel pipe, shall be driven to avoid any collapse of the tunnel.

7.10 MEASUREMENT

Measurement shall be made for the actual quantity in 3' of excavated trenches. The maximum width of trenches allowed for payment will be as follows

- a) Trenches not exceeding 6 feet in depth 24" plus external diameter of the barrel for pipe sewers.
- b) Trenches exceeding 6 feet and not exceeding 12' in depth, 30" plus external diameter of the barrel for pipe sewers.
- c) Trenches exceeding 12' in depth, 36" plus external diameter of the barrel for pipe sewers.

7.11 RATE

The unit rate tendered in the priced Bill of Quantities for excavation and back filling of trenches for sewer lines, shall be the full compensation for the cost of materials, labour, 1: 6: 12 equipment, tools and all incidentals necessary completely to execute this item of work strictly as per specifications laid down in this section.

7.12 PAYMENT

Payment shall be made at the unit rate quoted in the priced Bill of Quantities.

DISMANTLING & RESTORATION OF PAVEMENT SECTION- 8

8.1 DESCRIPTION

The work covered by this section of the specifications consists in furnishing all labour, equipment, appliances and materials and in performing all operations in connection with cutting and restoration of road/street surface and pavement, cut or damaged as a result of work accomplished under this contract, in strict accordance with this section of the Specifications and the applicable drawings, and to the satisfaction of the Consultants.

8.2 CUTTING OF ROAD/STREET SURFACE AND PAVEMENT

In cutting and breaking road or street surface and pavement, the contractor shall not use such equipment and appliances, which shall damage the adjacent surface. Existing paved surface shall be cut back beyond the edges of the trenches to form neat square cuts. The dismantled materials shall be placed on one side of the trench for reuse after backfilling, for the restoration of the road surface. Not more than 500 feet of continuous road, street surface shall be cut or disrupted at a time for laying the drains. The Contractor shall take all safety measures against traffic hazards and shall provide proper diversion for the traffic where necessary. The diversion shall be indicated by suitable street signs 3-feet by 4-feet in size. During night enough red lights shall be provided to warn the traffic.

8.3 RESTORATION OF ROADS/STREET SURFACE AND PAVEMENT

After backfilling of trenches the cut road/street surface and pavement shall be restored as quickly as possible to original foundations and grade and line in such a manner as to acceptable surface for traffic. Intersections shall be restored within 24 hours after being. The payment for this is included in the relevant items of BOO.

.....End of Section.....

SECTION- 9SOIL, WASTE, VENT, Upvc PUSH PIPES SYSTEMS

9.1 SCOPE OF WORK:

The scope of work of this section covers the soils, waste, vent uPVC push system pipe work.

9.2 MATERIALS

Pipes and fittings shall be uPVC of indicated grade and size, of M/s Dadax (NIKASI) or M/s HEPWORTH or M/s NIC, must be approved by the Chief Architect shall be acceptable.

9.3 CONFORMITY TO STANDARDS:

Pipes shall be perfectly straight and of uniform diameters and conforming:

DADEX(NIKASI) –Upvc pipe conforming to ISO- 3633 & PS-3214 with P.P fittings conforming to DIN-19560.

HEPWORTH –Upvc pipe conforming to BS-4513 & BS-5254.

N.I.C –uPVC conforming to BS-4514 pipe & fittings. Pipe spcers of M/s N.I.C or Equivalent.

Accessories like hangers, supports and achors shall be of approved design by the Consultants and shall be so arranged as to allow the pipes to lift.

9.4 JOINTING:

The pipes shall run exposed or embedded in walls and floors as specified or shown on drawings. Where embedding in walls or floors is required, Architect shall approve the necessary instruction and route of pipe work. Pipes running exposed on walls and ceiling shall be properly claimed with hangers, supports and clamps. For passage of pipes through masonry wall and R.C.C beams slab as walls, pipe sleeves shall be embedded and properly caulked and water proofed.

Horizontal soil and waste pipes unless otherwise specified shall be given a grade of ¼ inch. Per ft. and 1/8 inch per ft. respectively.

All main vertical soil stacks shall extend full size to above thereof line, except where wise indicated. The part of the soil stack carried up as vent pipe shall not have any bend oragnal except when unavoidable, in which case the angle shall be as suit as soil stack at point not less than 3ft above the highest connection to the soil stack. changes in pipe size of soil, waste and drain lines shall be made with reducing fittings or recessed reducers. All changes in direction shall be made by the appropriate use of 45 Yees, Long or short sweep ¼ to 1/16 bends, etc. or equivalent fittings as approved. Single and double sanitary tees and quarter bends may be used in drainage lines only where the direction of flow is from horizontal to vertical. Short sweep not less than 3 inches in diameter my be used where the change in direction of flow in either in plan or from vertical to horizontal and may be used for making necessary offsets between the ceiling and the next floor above. The use of short sweep bends or fittings, where deemed necessary because of installation conditions, shall be subject to the approval of Consultants.

Contractor shall provide offsets in the piping where required or directed by Consultants to avoid interference with other work, or to increase the headroom under piping or to improve the appearance of

the pipe work. All pipes shall be installed in such a manner as to prevent delay or interference with the work of others working in the same area. All openings in pipes shall be kept closed during construction work plugs.

9.5 SAMPLES:

Samples of all materials shall be got approved before use from the Consultants Manufacturer's test certificate shall be submitted to the Consultants stating that the pipes confirm to the specified grade/ test pressure.

Materials may further be got tested, if required by Consultants at Contractor's cost. Rejected materials shall be removed from the site of works immediately and same type of materials as approved shall be used throughout the works.

9.6 TESTING OF PIPE LINES:

No work shall be covered over or surrounded with concrete until it has been tested by the Contractor and in the pressure of the Consultants and approved by him.

9.6.1 Drainage pipes

The test shall be applied before the pipes are haunched with concrete. Water Test shall be carried out in uPVC pipes should be subjected to a test pressure of at least 5ft head of water at the highest point of the section under test.

The test should be carried out by suitable plugging the lower end of the drain and the ends of connections, if any, and filling the system with water. A knuckle bend should be temporarily jointed in at the top end and a sufficient length of vertical pipe jointed to it so as to vertical pipe jointed to it so as to provide the required test head which shall be maintaining for 30 minutes without showing a drop of more than 3 inches.

Any leakage visible shall indicate defective work, which shall be cut out and made good by replacement by the Contractor at his cost and retested for acceptance.

9.7 RATES

Rates shall be full compensation for everything required to be furnished and done to complete the work items as per specifications in all respects.

Inter-alia specified and required, the rates shall cover all costs for all material, labour T& P etc. and handling, laying, jointing, installation, fixing, painting, jointing, installation, fixing, painting, testing and dis-infecting. Protective coatings and wrappings specially required for metallic lines buried in earth as specified. Building of walls, floors and structure. Cutting holes through walls, floors or other structure and making good and finishing the same. Cutting chases in walls etc. and making good and finishing the same, fixing arrangements such as hanging systems, clamps, holders, bats, nuts, bolts, screws, sleeves etc., and all jointing materials.

9.8 MEASUREMENT:

Pipes shall be measured in running feet (as given in BOQ) of the finished length without adding lengths consumed in joints and without deducting lengths of specials, fittings, valves and the installed in the line.

.....End of Section.....

SECTION- 10 MISCELLANEOUS WORK

10.1 DESCRIPTION

The work covered by this section of the specifications Consists in furnishing all labour equipment, appliances and materials and in performing all operation in connection with providing water, sewerage and drainage and gas connections to the existing lines.

This Section of the Specifications is intended to cover all miscellaneous items which are not specifically Called for in other sections of these Specifications, Items shown or called for on the drawing, but not itemized herein, shall be furnished under the Conditions of this section and shall generally conform, as closely as possible to these Specifications unless otherwise directed by the Consultants.

10.2 MEASUREMENT

Measurement will be made for the actual work executed at the unit rate entered in the Bill of Quantities; all connections to the specified lines (i.e. water, sewerage and drainage) shall be lump sum.

10.3 PAYMENT

Payment shall be made at the unit rate stated in the Bill of Quantities. Such payment shall constitute full compensation for furnishing all materials equipment and labour including testing and all other incidentals necessary to complete the work according to the applicable drawings and directions of the Consultants.

.....End of Section.....

TECHNICAL
SPECIFICATIONS

(ELECTRICAL WORKS)

SECTION-1 GENERAL SPECIFICATION

1.1 SCOPE OF WORK:

The Work under these specifications includes providing of all materials and equipment and performing the work necessary for the complete execution of all the electrical works, as shown on the Drawings, and as specified herein, which shall include, but not be limited to, the items in the Bill of Quantities.

The Scope of work also includes the arrangement of inspection by, and the obtaining of all necessary clearances; certificates, etc. from the relevant authorities.

1.2 CODES, STANDARDS, PERMITS

The electrification work shall be carried out by licensed workmen authorized to undertake such work under the provisions of the Electricity Act, 1910 and the Electricity Rules 1937, as adopted and modified by the Government of Pakistan.

The installation in general shall be carried out in conformity with the Electricity Rules 1937, and the Fifteenth Edition (1981) of the Regulation for the electrical Installation (IEE Wiring Regulation) issued by the Institution of Electrical Consultants, London (IEE). However in case of conflict between the technical specification and the EWW Regulation, these technical specifications shall be followed.

Any special requirements of the local electrical Supply Company and of the Regional Electrical Inspector shall be complied with. The Contractor shall also be responsible for submitting the test certificate and getting the installation passed by the Regional Electric Inspector, Government of Pakistan.

The Contractor's license number and supervising competency certificate is to be furnished before the Work is taken in hand. The bio-data of the supervisor shall be submitted before commencement of the work for approval of the Consultants/Consultant.

The Contractor shall familiarize himself with all requirements as to permits licenses, fees and codes and arrange to comply with them. All permits, licenses, fees, inspection and arrangements required for the Contractor at his own expenses shall obtain the work under this Contract.

1.3 MATERIALS

All materials shall be in accordance with the types and manufacture described in the Bill of Quantities and or as shown on the relevant Drawings. Where the Contractor desires to use materials differing from those described, he shall obtain the approval of Consultants/Consultant in writing before tendering. Materials shall be in accordance with appropriate Pakistan and British and VDE standard specifications. The Consultants/Consultant to inspect materials on SITE at reasonable times and to reject any materials not complying with the specifications reserves the rights. The cost of any dismantling and or re-erection of the installation occasioned by the removal of rejected materials shall be borne by the Contractor.

1.4 CUTTING FLOORS, WALL OR CEILING

The Contractor should work out in advance the position of holes, channels, etc., to be left in the Building structure. Where this is not reasonably possible, cutting and chipping of walls, etc. may be permitted only with the Written permission of the Consultants/Consultant. All cutting and chipping of walls, etc. For installing materials concerning electrification will be done by the Contractor who shall also repair any damage caused and will be responsible for bringing back the general finish to the position as it was before the cutting and chipping done by the Contractor Cutting, chipping, repairing, patching of plaster and finishing of carpentry work, metal work of concrete work, etc., which may be required for the electrical work, shall be done by craftsmen skilled in their respective trades, when cutting is required, it shall be done in such a manner so as not to weaken walls partitions or floors. The holes required to be cut in floors must be drilled without breaking out around the holes. Where patching is necessary in finished areas of the Building, the Consultants/Consultant to determine the extent of such patching and or refinishing reserves rights. The work should be done only upon the express instructions of the Consultants/Consultant.

1.4 SLEEVES

Through floors and walls shall be of black iron pipe, flush with walls, and ceiling or finished floors of a size to accommodate the conduit. Sleeves through outside walls shall be chalked with an approved chalking material.

1.5 IDENTIFICATION OF CIRCUITS

Switch panels; fuse boards, machine control centers and similar distribution units shall be designated in accordance with the reference of number used in the Specifications and or shown not on the Drawings but the legend and description shall clearly spell out the full name of the equipment.

- A. All distribution boards shall be provided with detailed circuit sheet fixed by Screws inside the front cover. The function of each circuit shall be clearly printed on the Chart under the respective circuit number. Spare branch way shall not print, " SPARE" but left blank.
- B. On A.C. system the phase sequences shall be maintained through the installation and all phase connection shall be in the order of red, yellow, blue from top to bottom and or left to right. Neutral connections are to be kept below or to the side of the phase connection of the link or bus bars provided for the purpose.
- C. Tee particular phase connected to a N.F.B. AND bus bar shall be clearly indicated by making with the appropriate colour.
- D. Where low voltage of 400 or above exists a label shall be fitted externally so as to provide for easy access for operation, repair and maintenance. If concealed, access doors shall be provided.

1.6 ACCESS TO EQUIPMENT

Contactors, starters, switches, outlets, pull boxes, etc, shall be located so as to provide for easy access for operation, repair and maintenance. If concealed, access doors shall be provided.

1.7 PROTECTION OF APPARATUS, ETC

Necessary precautions must be taken to properly protect all apparatus, fixtures appliances, materials, equipment and installations from damage of any kind. Failure to provide such protection to the entire satisfaction of the Consultants/Consultant shall be sufficient cause for the rejection, of any particular piece of material, apparatus equipment, etc.

1.8 OPERATIONS AND MAINTENANCE MANUALS

During the time of the CONTRACT and before final approval of the electrical installation, three copies of descriptive literature of maintenance and operation data and parts list of each item of electrical equipment installed under this CONTRACT should be submitted to the Consultants/Consultant.

1.9 ELECTRICAL DEFINITIONS

These specifications and Drawings are based on electrical systems and apparatus terminology defined in the INDIAN Electricity Act and Rules as adopted in Pakistan and latest edition of the regulation for Electrical installation by I.E.E edition (London). If some clarification is required in some instance a reference should be made to the Consultants/Consultant whose interpretation will be binding and final.

1.10 OUTLET LOCATIONS

A. Position of OUTLETS:

Center all outlets with regard to paneling, Furring, trim, etc. Where several outlets occur in a room, they shall be symmetrically arranged. Outlets improperly located or installed shall be satisfactorily corrected. Outlets shall be set with the finished surface of the wall without projecting beyond it. Receptacles, switches etc. shown in work trim cases or other fixture shall be set with the long dimension of the plate horizontal or gauged in tandem.

B. Mounting Heights:

Mounting heights, to bottom of box above finished floor for the below named item shall be as follows, unless otherwise shown or indicated during construction:

Pendant florescent lighting fixture	2700mm
Switch box mounted single or Multiple flush switches	1200mm
Telephone outlets on wall	50mm
5 Amps and 15 Amps outlets Away form switch boards	50mm
Fire alarm power bell	2200mm
Wall bracket lights	2100mm
Distribution Boards	1350mm
Call bell outlets on wall	50mm

1.11 PROTECTION OF WORK

Contractors shall effectively protect his own work form damage during and, as may be necessary, after installation, and he shall likewise protect adjoining work of other trades from damage resulting form installation of electrical work.

1.12 Testing

A. General:

Upon completion of the installations, the CONTRACTOR shall perform field tests on all equipment, material and system. All tests shall be conducted in presence of ARCHITECT'S

representatives. In general all Tests made by the CONTRACTOR shall be of the nature to ensure that the Installation is sound and that the circuits, lighting and power and equipment etc. will function properly and as intended.

B. Installation Tests:

The insulation resistance test shall be performed on all Electrical equipment and wiring. Using Megger tester or any self contained instrument such as direct indicating ohmmeter of the generator type. Only D.C. potentials shall be used for such testing and these shall be as follows:

Circuit under 220 Volts	500 test voltage
Circuit 230 to 400 volts	1000 volt test

Minimum acceptable insulation value of PVC cables shall be 1 mega OHMS. Insulation test between each cable of a circuit shall be made and also between earth and individual cable. All equipment shall be tested to earth.

If the insulation resistance of the circuit under test is found less than specified above, the cause of low reading should be determined and removed. If equipment is found to contain moisture the corrective measures shall include dry out procedure by means of heater but if the circuit cables are found defective these shall be removed and replaced and tested again. The test shall be carried out at least three times and the lowest reading shall not be less than 70% of the average value.

C. Earth Resistance Test:

The CONTRACTOR on the Earthing system shall make Earth resistance test by separating and reconnecting each Earth connection as may be required.

The electrical resistance of the E.C.C. together with the resistance of the Earthing lead measured from the connection with earth electrodes to any other position in the completed installation shall not exceed one Ohm.

D. Phase Sequence Test:

The CONTRACTOR shall determine correct rotation of all motors and phasing the entire power installation before final connections to the line. Final connection shall only be made after correct phase relation of Power Company's primary line has been established

1.13 As Installed Drawings

The CONTRACTOR shall during the progress of the work, keep a careful record of all changes where the actual installation differs from that shown of the CONTRACT Drawings. The CONTRACTOR shall in a neat and accurate manner make a complete record of all changes and revisions to the original design, as installed in the completed work. These as-built Drawings shall be submitted to the ARCHITECT for approval. After approval they shall become Owner's property. Final payment will be withheld until receipt of the approved as installed drawings.

The CONTRACTOR shall have on file, for ready access and reference, a set of drawings indicating all work as actually installed incorporating in the same all the changes and additions. Upon the termination of the CONTRACTOR, he shall prepare a set of tracings indicating there in the Electrical work as actually and finally installed. These tracing shall be handed over to the Owner through ARCHITECT.

1.15 Shop Drawings and Samples

- A. The Contractor shall prepare and submit for approval to ARCHITECT drawings and cuts of all equipment, appliances and fixtures furnished. After final approval a sufficient number of copies as directed shall be furnished for distribution. Fixtures and devices. Cuts and or catalogues shall be clearly marked to indicate the items furnished. Individual sheets, cuts, catalogues or drawings will not be accepted. For instance, lighting fixture cuts should be for all fixtures furnished, rather than a few types.
- B. The CONTRACTOR shall submit samples of conduits, wires, wiring devices, finished plates and of any other items as may be asked by the ARCHITECT for his approval. No material shall be ordered or installed without the written approval of the ARCHITET.

1.16 Cooperation

The CONTRACTOR shall co- operate in every way and work with all other specialist Contractors to whose apparatus he shall connect a part of his work, and provide in his work connections and facilities for connections of their work.

1.17 Minor Modification

The plans as drawn are based upon architectural plans and details and show conditions as accurately as it is possible to indicate them in scale. The plans are Diagrammatical and do not necessarily show all fittings, etc. necessarily to fit the Building conditions, The location of outlets, apparatus and appliance shown not he a plan are approximate. The CONTRACTOR shall be responsible for the proper location in order to make them fir with architectural details and instruction given to him at the Site.

1.18 Guarantees

The CONTRACTOR shall guarantee that the electrical systems are free from all Ground and from all defective workmanship and materials and will remain so far a period of one year from date of acceptance of the work. The CONTRACTOR at his own expense shall rectify any defects appearing within the aforesaid period.

1.19 Approvals, Substitutions etc.

Where herein after the words " For approval" or " Approved" (make, type. Size, arrangement, etc.) Are used, especially in regard to manufactured specialties, etc. or wherever it is desired to substitute a different to the adequacy and adaptability of the proposed apparatus, shall be submitted to the ARCHITECT and their written approval secured before the apparatus is ordered or installed.

1.20 Sub- Contractors, etc.

The CONTRACTOR shall be held fully responsible for the work of any sub-contractor or manufacturer performing work for or supply materials from, as it is intended that the entire Electrical Work, when finally delivered to the OWNER shall be ready in every respect for satisfactory and efficient operation.

1.21 Workmanship

The work throughout shall be executed in the best and most thorough manner under the direction of the ARCHITECT and to his entire satisfaction. The ARCHITECT to reject any work and or material reserves rights, which are not in full accordance with the Drawings and specifications and shall have the power to reject any work and material which in his judgment are not in full accordance therewith.

1.22 Approval of material, etc.

All electrical materials shall be brand new and shall meet the requirements of Pakistan Standards Institute or equal specifications. As soon as practicable and within thirty days after the official award of CONTRACT and before any materials or equipment are ordered, the CONTRACTOR shall submit for ARCHITECT'S approval, one complete list of materials, apparatus and equipment, in triplicate, giving the manufacturer's name, address, descriptive data, trade name of items, rated capacities, certified analysis, catalogue numbers, etc., and when called upon to do so, complete specification and cut or drawing of each item, of whole or portion of list, as required which is proposed to be used or installed

1.23 Inserts, ANCHORS, etc.

The location of various items indicated on the Drawings are presumed to be approximately correct, but it is to be understood, however, that the small scale Drawings are necessarily diagrammatic and that such locations as shown, are subject to slight revision, as the work is installed, which may be necessary to accommodate local construction. No major change shall be made, except with the approval in writing. The CONTRACTOR shall examine and study the architectural scale Drawings, large scale and full size details, the approved shop drawings of other trades and he shall frequently conduct with the ARCHITECT to ascertain any changes that may have been made, and he shall be guided accordingly before establishing the precise location of conduit runs, panel, pull and junction boxes, and outlets for all lighting, power telephone, fire alarm and sound system. All outlets covered for partially covered by ducts, piping etc. shall be extended laterally or to underside of it so that fixtures may be properly installed. Outlets indicated where beam occurs shall be located adjacent to same, with proper clearance for fixtures as required.

1.24 Inspection, Acceptance and Rejection

A. The CONTRACTOR shall furnish promptly without additional charge all reasonable facilities, labour and assistance for the safe, convenient inspection and or testes which may be required. All inspection and tests will be performed in such a manner as to avoid unnecessary delay of the work.

B. The rights are reserved for all times and places by the ARCHITECT to reject articles or materials to be furnished here under which in any respect, fail to meet the requirement of these specifications regardless of whether the defects in such articles or materials are detected at the point of manufacture or after delivery to the SITE. If the ARCHITECT, through an oversight or otherwise has accepted unsuitable materials, no matter in what stage or condition of manufacture or delivery, said material may be rejected. Compliance with the specification is the responsibility of the CONTRACTOR and this shall not be vided by act of commission on the part of the ARCHITECT.

C. No inspection or acceptance of, or payment, by the OWNER of, for any of the materials described herein shall relieve or release the CONTRACTOR from any obligation pertaining to the conditions of CONTRACT.

D. Appointment of Inspector:

The OWNER shall on his own discretion appoint representative for inspection of stores at manufacture's work and or at port of embarkation and disembarkation and or at SITE and this shall be conveyed to the CONTRACTOR who should then keep the representatives duly informed of the progress with copies to be submitted.

1.25 Foundation, Pads, Bases, Supports and Fasteners

A. Channel sills for leveling and support of all floors mounted electrical Equipment shall be provided as part of the Electrical work.

- B. Where an item of floor-mounted equipment is to be installed, floor and deck Loading shall be checked. If it is found that permitted loading have exceeded by direct application of the equipment on the slab or deck, suitable Dun age approved by the ARCHITECT shall be provided, to make the Electrical Work to distribute the weight in a safe manner. The CONTACTOR shall submit the Loads of each equipment to the ARCHITECT.
- C. All necessary concrete foundation pads and bases exterior to the Building for Lighting installation or other electrical equipment installed as part of the Electrical work including such base or foundation as detailed on architectural drawings shall be provided as part of the electrical work.
- D. Supporting methods for all electrical equipment and circuitry shall conform to be best practice, shall utilize only approved materials and shall be in accordance with the standards published by the United States National Electrical Contractor Association BS.S. Specifications.
- E. All fastenings to attach electrical work to the Building structure shall be of an approved type, in general, the only acceptable fastening methods shall be as follows.

Wood screws on Wood

Bolts and expansion shields on concrete or C.C.Masonry.

Toggle bolts on hollow Masonry.

Machine screws approved clamps or welded threaded studs on steel.

1.26 Spares

- A. When main equipment is part of OWNER'S supplied material, the 12 months maintenance spares supplied by the equipment manufacturer will be handed over to the CONTRACTOR who will maintain record. For equipment which are part of CONTRACTOR'S supplied material, the CONTRACTOR will maintain a similar recorded of consumption of the maintenance spares supplied by the equipment supplier in accordance with the requirement of this contract and hand over the unutilized spare part to the OWNER at the end of the maintenance period.
- B. Any spare parts required by the CONTRACTOR for satisfactory completion of maintenance work during the maintenance period but not supplied by the manufacturer, as the CONTRACTOR through his own resources and at his own cost shall procure normal supply with equipment.
- C. A list of spare parts as recommended by the manufacturer or as specified for the maintenance of installation for a period of two years (or as specified otherwise) after expiry of maintenance period shall be quoted. Individual prices shall be quoted for each recommended spare.

1.27 Electrical Service Connection

It shall be the CONTRACTOR'S responsibility to intimate the power supply authority and make such tests as required by them to demonstrate conformation with their regulation prior to their connection to the installation. The extent of work here in specified represents the minimum requirements and the extent of work shall be extended as required to include at no increase in cost compliance and fulfillment of the requirements of the local power supply authority for an installation of this type.

If inspection by the government constituted body is to be carried out, the CONTRACTOR shall be responsible for carrying out he it. If any fee is paid for such inspection CONTRACTOR at shall pay the same actual upon presentation of payment receipts.

.....End of Section.....

SECTION-2INTERIOR WIRING REQUIREMENTS

2.1 Scope

The work included under this section consists of furnishing all labour, materials, services and skilled supervision necessary for the construction, erection, installation and connection of all circuits and equipment specified herein, shown or noted on the Drawings, and /or normally for an installation of this type and its delivery to the EMPLOYER upon completion in all respects ready for use. The extent of work specified herein and/or shown on the DRAWINGS represents the minimum requirements.

2.2 Workmanship

All materials and equipment shall be installed in accordance with recommendations of the manufacturer as approved by the EMPLOYER to be conformed to the CONTRACT Documents. The Workmen skilled in this type of work shall carry out the installation.

2.3 Wiring Method

The wiring shall consist of insulated conductors installed in PVC Pressure Pipe class D (Conduit) BS 3505) or flexible conduit for equipment connections or as shown on the Drawings.

2.4 Conduit and Conduit Accessories

The PVC Pressure pipe class D (conduit) shall be electric grade manufactured according to BS 3505 1968 PVC pipe. Conduits shall be installed in accordance with applicable codes and regulations. Minimum size of conduit shall be 25 mm unless noted otherwise. Conduit shall be concealed within finished walls, ceilings, and floors where possible and shall be kept 150 mm away from parallel runs of flues and steam or hot water pipes. Conduit shall be supported and secured at intervals of not more than 60mm. Exposed conditions shall have runs installed parallel or perpendicular to walls, structural members or intersections of Vertical concrete places and ceilings. Field made bends and off sets shall be made with tools, specifically made for this purpose. Change in direction of runs shall be made with symmetrical bends or cast metal fittings. A maximum of two 90-degree bends will be permitted without a pull box. Cracked or deformed conduit shall not be installed. Trapped conduits in damp and wet locations shall be avoided where possible, care shall be taken to prevent the lodgment of plaster, dirt, or trash in conduit, boxes, fittings, and equipment during the course of construction. Clogged conduit shall be entirely freed of obstructions or shall be replaced. Conduits shall be fastened to all sheet metal boxes and cabinets with flanged couplings or with locking and insulation bushing cabinets with flanged couplings or with locking and insulation bushing duly approved by the ARCHITECT. Bushing shall be installed on the ends of all conduits.

These standards and specifications will be same as those of M/S NIC, M/S Dadex.

2.5 Installation

General requirements applying to the installation of the conduits shall be as follows:

A. Concealed Conduit Runs

The conduit runs shall be concealed in ceilings, floors slabs, columns, walls, etc. Changes in direction of conduit runs shall be made with sweep bends using bending machines in case of steel conduit or with being spring in case of PVC conduit. Standard conduit bends and elbows may be

used to facilitate installation and where conduit runs out of thin slabs. Where conduit is to be concealed in RC work they laying of conduit shall be laid above the bottom reinforcement steel of the slab and shall be firmly secured to the steel in order to avoid displacement during the pouring or vibrating of concrete. After pouring, the conduit shall have a cover of 40 mm to 50 mm. Junction boxes, pull boxes, outlet boxes, etc., shall be held firmly and shall be flush with the soffit of the slab or beam. The heights of these boxes shall thus be appropriately sized. No reinforcing steel shall be displaced to accommodate the instigation of conduit and outlet boxes. Outlet boxes shall be installed in beams. In general all embedded conditions shall be located in the physical center of the particular section of concrete.

All opening through which concrete may leak shall be carefully plugged and boxed they shall be suitable protected from filing with concrete.

All ends of conduit shall utilize flaring prevent sharp edges of conduit ends from cutting or damaging wires and cables to be pulled through them.

Conduits passing through expansion joints in concrete slabs shall b provided with expansion, fittings.

Conduits to be installed in already poured RC members shall be placed in chases such that a minimum cover of 1.25" is available prior to plastering. Chasing routes shall be determined after coordination and clearance with all other trades. Holes for conduits passing through RC members shall be of the minimum possible diameter and cleanly made. Conduits shall be run at least 6" away form flues, steam or water pipes.

B. Conduits on Surface

Exposed runs of conduits shall be as indicated on the DRAWING. Conduits shall be firmly held to bearing surface by means of clamps, saddles, brackets, etc. Surface Rawal Plugs or Phil Plugs shall be used for fixing of such supports. In cases where the use of such plugs is not feasible, wooden plugs may be used with prior permission of the CONSULTANTS, such that these are fixed a maximum distance of 30" o.c. Straight runs of conduit shall run not more that 18" to 24" below the slab. If hindrances are encountered, conduits shall be run around, above or below such hindrance, as the case may require, and then the run shall continue at the same level as before. Exposed conduits and accessories shall be painted in approved anti- corrosive paint before and after installation in case of steel conduits. In all areas where conduits may be exposed to damp or wet conditions, supports shall be fixed with areas or stainless steel screws. Conduits mounted on walls, slabs, columns, etc., shall be mounted with a minimum gap of 6 mm in between. In no case shall a conduit be mounted flush or in contact with such bearing surfaces. Across beams, plain stamped saddles shall be used. Samples of all such supporting devices shall be submitted to the ARCHITECT for approval prior to their incorporation in the WORK.

C. Conduit in Plain Concrete

Conduit shall not be placed in plain concrete such as cement toppings on R.C.slabs, without prior approval of the ARCHITECT.

D. Conduit through Roof

Where conduit penetrates the roof seal, suitable pitch pockets or load flashing shall be provided. Shop Drawings shall be provided for method used.

E. Conduit in Furred Spaces

In general, conduits shall be anchored and strapped to the Building structure, Conduit shall not be installed resting on ceiling furring channels or attached to furred ceiling hanger wires without the CONSULTANTSS' written approval.

F. Straps and Hangers

Straps, suitable clamps or hangers to provide a rigid installation shall substantially support conduit. Perforated straphanger and twisted wire attachments will not be acceptable. In no case conduit shall be supported on other pipe.

G. Joints and Connections

Couplings and threaded connections in threaded conduit shall be made up watertight. All joints shall be cut square, reamed smooth and properly threaded. No running threads will be permitted. All box connections shall be fitted with an approved lock nut and brass bushing forming an approved right bond with box.

Plastic bushings may be installed provided lock nuts are installed both inside and outside of the enclosure to which the conduit is attached.

H. Wiring Cables

All wiring cables should be copper. The cables shall be PVC insulated suitable for use in conduit or trucking. Wire connectors of insulated material or solder less pressure connectors properly taped shall be utilized for all splices. Soldered mechanical joints insulated with taps shall be kept to a minimum. Vinyl tape of suitable quality is acceptable in lieu of rubber and friction tapes. All devices and methods utilized for splicing and/or terminating cable shall be suitable for use with copper wires and shall be in strict accordance with the cable manufacture's recommendations.

The BSS standards and specifications of wires and cables will be same as those of M/s Pakistan Cables (Pvt.) Ltd.

I. Conduit Sizes

Conductor sizes shall not be less than the sizes indicated. Branch circuit conductors shall not be smaller than 1.5mm². Remote control and signal circuit conductors shall be not less than 2.5mm².

J. Wire & Cable Installation

All wires and cables shall be arranged to provide bends of reasonably large radii, whether run in conduit or on timber battens. Minimum radii shall be 10 times the overall diameter of the cables. Wiring between terminations shall be continuous and joints or connectors shall not be used unless with prior approval of the ARCHITECT. On all wiring for HAVC equipment, live load and neutral shall be contained in the same conduit, and every single pole switch and circuit breaker in a 2 wire derived form 3 wire circuit or 4 wire circuit or supply must be fitted in the phase conductor of such supply.

The quantity and size of cables contained in any one conduit shall not exceed the numbers as below, as per IEE Regulations:-

Wire Size (mm)	Conduit Size		
	20 mm	25 mm	32 mm
1.5 31	1.5	10	17
2.5 20	2.5	7	11
4 16	4.0	5	9
6 4	6	4	7
10 7	10	2	4
16 5	16	-	3
25 3	25	-	2
35 2	35	-	-
50 2	-	-	-

L. Water in Conduits

Water that has entered a conduit system shall be removed by drawing Swabs through the conduits, or an alternate suitable method with a prior Approval of the ARCHITECT. No cables shall be pulled until the water has thoroughly dried out.

M. Stripping off insulation

The insulation of cables shall always be brought into fixtures such as luminaries, accessories, etc., to which cables are connected. All opening where insulation is removed shall be sealed by means of a plastic compound or other means with prior approval of the CONSULTANTS.

N. Earth Continuity Conductor (ECC)

Circuit and Sub-main wiring shall have an Earth Continuity Conductor (ECC) as per IEE regulations, but not less than 2.5mm, run alongside it and bonded to all its fittings, as well as all other metal work not intended to carry current. When cables are run in conduits, ECC shall be run in the same conduit. The maximum continuity resistance from any point of the installation including the earth Continuity and earthing lead to the earth electrode shall not exceed one Ohm.

The removal of insulation from the individual cores shall be carried out by thermal insulation removers and not be cable knives combination plies or side cutters as is conventionally practiced.

2.6 Conductor Identification

The conductor identification of Branch Circuits shall be by colour coding. Control circuit conductor identification shall be made by colour coded insulated conductor, plastic coated self sticking printed markers, permanently attached stamped metal foil markers, or equivalent means as approved by the ARCHITECT. Conductor identification shall be provided within each enclosure where a tap, splice or termination is made. Control circuit terminals of equipment shall be properly identified. Terminal and conductor identification shall match to that shown on approved shop Drawings. Hand lettering or marking is not acceptable.

2.7 Outlets

Each outlet in the wiring or conduit systems shall be provided with an outlet box to suit the conditions encountered. Where outlet boxes are exposed to the weather or normally wet locations, including flush and surface mountings on exterior surfaces of exterior walls exposed on walls and in explosive locations, boxes shall be of the CST metal type having threaded studs. Boxes in other areas shall be of the black enameled sheet steel or zinc coated sheet steel type. Each box shall have sufficient volume to accommodate the number of conductors entering the boxes, in accordance with the code requirements. Ceiling and bracket outlet boxes shall be not less than 3" rectangular except that smaller boxes may be used where required by the particular fixtures to be installed or approved by the CONSULTANTS. Boxes installed in concealed locations shall be set flush with the finished surface and shall be provided with the proper type expansion rings or plaster covers where required.

A. Boxes for use with conduit system: Shall be not less than 37.5mm deep except where lower boxes are required by structural conditions and are approved by the ARCHITECT. Switch and socket outlet boxes shall be not less than 90 x 90 x 75mm. Telephone outlets shall be sized as recommended by the Telephone department for the installation shown on the DRAWINGS. All boxes shall be concrete tight where installed in concrete or other fluid material.

B. Pull Boxes shall be not less than the minimum size required by the codes and shall be constructed of heavy gauge sheet steel. Boxes shall be furnished with screw fastened covers for multiple cables passing through a common pull box, the feeders shall be tagged to indicate clearly the electrical characteristics, circuit number and panel designation.

The maximum spacing between pull boxes on conduit runs shall be as follows:

- | | |
|------------------------------|--------|
| 1. Straight Runs | 100ft. |
| 2. Runs with one 90 deg bend | 50ft. |

The minimum length of all inspection/ pull boxes shall be four times the cable manufacture's recommended bending radius of the respective cable.

2.8 Outlet Cover Plates

Where not integral with the device shall be of the one-piece type and shall be provided for all outlets to suit the devices installed. Plates on unfinished walls or one the fittings shall be of primed sheet steel having rounded or beveled edges. Plates on finished walls shall be of brushed bronze or bronze plates brass, provided with beveled edges. Screws shall be of metal with counter sunk heads, in a colour to match the finished wall surface without the use of mats or similar devices. Plates shall be installed vertically and with an alignment tolerance of 1.50mm. The use of sectional type device plates will not be permitted.

2.9 Socket Outlets

- A. In general socket outlets are 3 wire, line neutral and ground, 5/15/20 Amps, 250 volts, with grounding slots.
- B. All socket outlets in finished areas shall be flush mounted. Weatherproof socket outlets shall be instead in cast metal boxes, with screw cap to cover outlet.

Switched socket outlets with or without neon light will be 87mm x 87mm for 1- gang and 147 mm x 87mm for 2- gang with or without neon lights. (E 15/5N, E 15/5, E15, E15N. E25. E25N. E426/15). There will also be polycarbonate thermal plastic, fire resistant, operation life 50,000 times (min), zero% power losses on terminals, no sparking on terminals, 100% flexibility against voltage fluctuations.

All these will be as per BS.3676 British Standards and specifications and those of M/S Clipsal Co.

2.10 Switches.

In general switches shall be 5 Amps in flush mounted installations or where surface mounted with covers of an identical size with the outlet box. Where the DRAWINGS indicate two switches side by side or switch and receptacle side by side, they shall be mounted in a multiple gang box with appropriate cover. Finish on all plates in painted areas shall be brushed bronzed or as approved by the ARCHITECT.

The sizes of these switches will be 87mm x 87mm for 1 gang, 2- gang, 3-gang, 4-gang and 5-gang, 1-way, 2- terminal whereas size will be 147mm x 87 mm for the gang, 1 way, 2 terminal flush type switches (E31/1/2A, E32/1/2A,E33/1/2A, E34/1/2A, E35/1/2A, E36/1/2A)(E-Series)

These will also be polycarbonate thermal plastic, fire resistant, operation life 50,000times (min), zero% power losses on terminals, no sparking on terminals, and 100% flexibility against voltage fluctuations.

These entire etc. will be as per BS: 3676 British Standards and specifications and those of M/S Clipsal Co. or as approved by the CHIEF ARCHITECT.

SECTION-3CABLES & ACCESSORIES

3.1. GENERAL

Power cables conforming to these specifications, described in the B.O.Q. and as shown on drawings shall be supplied, tested and installed. The cables shall be manufactured as specified hereunder.

3.2 11/15 KV POWER CABLES (H.T CABLES)

All XLPE cables shall be manufactured to I.E.S. standard 502 or BSS-5467.

The XLPE cables shall be provided with extruded semi conducting conductor screen over stranded circular copper conductors before XLPE insulation is provided. On each core of conductor another layer of extruded semi-conducting core screen and copper tape screen are provided. The number of cores required then shall be put together and the antisepses filled with non-hygroscopic fiber filler and binding tape. The core is extruded with another PVC bedding.

Galvanized steel Armour is provided underneath an overall PVC sheath.

11-KV XLPE cables shall be manufactured by M/S Pakistan Cables Ltd or M/s Pioneer Cables Ltd. or as approved by the Consultants In-charge

The high-tension cable shall be cross-linked polyethylene (XLPE) insulated of 11/15 KV grade.

The conductor shall be of high purity copper stranded circular conductor. The conductors shall be provided with conductor screening with a layer of semi conducting cross-linked co polymer applied over the insulation. The cross shall have copper tape screened. The cable shall be PVC bedded, armored, and PVC over sheath. The Armor will comprise galvanized steel wire. The cable in general will comply with IEC 502-1978.

The jointing accessories shall be of manufacturer of repute. The cold pouring resin-jointing system shall be applied. The resin shall be nontoxic bonding the thermoplastic sheet cable material with excellent electrical and mechanical prosperities. The resin shall have two separate ingredients, a power and a liquid mixed in power bag. The mixed resin shall be given the time required for setting then back filling applied. For conductor and Armor connections, compression fitting of identical specification shall be used.

The XLPE cable termination shall be made as shown on the Drawings and shall be based on heat shrinkable material, it is necessary to make of the protective armoring. This to be done either by mechanical glands or by an alternative Armor clamping arrangement.

3.3. L.T. CABLES

All the low tension cables shall be of size specified on the Drawings or stated in the schedule of quantities, single core, 3 cores, or 3-1/2 cores 4-core, PVC insulated and PVC sheathed. The cables shall be used either in floor trenches or in conduit and therefore should be suitable for above conditions.

The Low Tension cables shall be manufactured to the requirements of B.S. 2004, B.S. 6004, B.S.3346, B.S.6346 latest or VDE 0271 and rated at 250/400 and 600/1000 volts as the case may

be. The cables for street lighting shall be with split concentric neutral to B.S.S. 4553/latest. The cables shall be manufactured by as approved manufacturer.

The conductors shall be annealed copper conductors, single or stranded, circular or shaped as the case may be, to B.S.S. 6360/69.

The Conductors specified for use in the cables shall be of at least 98.00% IASC conductivity.

The reference temperature for the purpose of determining the standard resistance of the conductors shall be 20 degree centigrade.

The conductors shall be insulated with poly-vinyl-chloride insulation. The minimum thickness of the insulation shall be in conformity with the specifications to which it is manufactured.

On all multi-core cables proper markings for core identification shall be provided to B.S. Specifications.

Power cables shall be multi-core cables, insulated and sheathed, armored or un-armored as required/approved.

Various conductors forming the cables shall be laid together and voids shall be filled with soft plastic or fibrous materials so as to give a circular shape to the cable.

A tough PVC shall be extruded over the cable so as to cover the insulated conductors and fillers.

Where armoring is required, a soft PVC jacket shall be provided over the laid up cable. Steel wire armoring shall be applied on a tough PVC sheathed extruded over the cable so as to cover the insulated conductors, fillers, jacket and armoring.

Complete identification of the cable together with Owner's identification markings if required shall be embossed on the final over sheath of the cable at every meter length.

The following tests shall be carried out by the manufacturers: -

- i) Dielectric Strength Test
- ii) Instantaneous and long-time break down strength test.
- iii) Temperature rise test.
- v) High voltage test.

Test certificates covering all these tests shall accompany the cables supplied by the Contractor.

After carrying out the tests as laid down in these specifications both ends of the cables shall be sealed at the manufacturers works.

The cables shall be delivered wound over strong drums of suitable dimensions. The cables ends shall be fastened to the drums and completely protected in suitable manner to protect any injury to the cables during transportation and handling. The direction of rolling shall be clearly marked with bold arrows on both faces of the drums.

The Owner may require the Consultants/Consultant to witness the tests as specified herein and the Contractor shall make necessary arrangements for the presence of the Consultants on such tests and obtain their signatures in testimony thereof without any cost to the Owner.

The L.T. cable end box shall be suitable for termination and sealing 3 ½ core 1000 volts, PVC insulated or armored and served cable of size specified conforming to B.S 480, Part-1, 1954 and as used on 3 phase, 4 wire, 50 cycle system. Brass wiping glands of the, Universal, type suitable for a minimum size of cable shall be fitted to the box. The gland shall be tapered and grooved to facilitate cutting to suit cable of greater diameter up to the size of 300 mm². The box shall be made of ferrous material and shall be painted with corrosion resisting paint preferably gray in colour.

The box shall be fitted with horizontal insulator bushing placed vertically one above the other to suit bus bar connections. Insulator shall be made in one piece of glazed porcelain and shall conform to B.S.223: 1956.

Clamps for clamping and bending the Armor of the cables to the terminal box and other installation materials shall be provided where needed.

3.4. CABLES TERMINATIONS

All PVC power cables shall be terminated with suitable tinned brass cable glands for securing the armour wires and incorporating a packing ring for exclusion of water and moisture. The cables shall be secured at required spacing by means of cleats fixed to walls or roofs or hangers and where multiple runs occur perforated metal tray made of heavy gauge- galvanized steel shall be used.

3.5. CABLE MARKER

For underground installation cable position markers shall be sited in the ground where cables change direction and at 30-meter intervals along straight runs of the cables. Markers shall also be provided to locate the position of joints. Cable markers shall be made of cast iron. Anyone of the following words shall be embossed/engraved for the identification of cable routes.

11000	V cable
440	V cable
11000	V cable joint
440	V cable Joint

The markers shall comprise of a cast iron circular disc of 115 mm dia and 10 mm thick to which an angle iron 25x3 mm bar 710 mm long shall be riveted at one end. The end of the bar shall be fork- opened up to a length of 75 mm. This end shall be embedded in a cement concrete block of ratio 1:3:6 to a length of 180 mm. The concrete block shall have a shape of truncated pyramid with base dimensions of 305x305 mm and top dimensions of 152x152 mm and a vertical height of 200 mm. The cable marker shall be buried in the ground such that its total height above ground level is 267 mm

3.6 CABLE JOINTS

The Contractor shall be in possession of a cable jointing kit and all termination, shall be made by a bona-fide and experienced cable joiner. All cable termination boxes kits and glands shall be of recognized makes and complete with claw clamps, ferrules, lugs, tapes, solders and jointing compounds.

3.7 INSTALLATION INSTRUCTIONS

The Contractor shall be under obligations to provide all labour, material and accessories for the installation of cables shown on drawings and listed in the BOQ conforming to the specifications in this section.

The Contractor shall provide without any extra cost, all material for termination of cables such as lugs, solders, clamps, supports, ferrules, bushes, fluxes, tapes, fixing pins, identification tags, earthing clip, straps for a complete terminal jointing operation in accordance with the best modern practice.

For underground cable installation the depth of digging the trench shall be such that the top surface of the cable shall not be less than 900mm and more than 1100 mm from the finished ground level. It will be contractor's responsibility to obtain true trench levels.

Cable routes indicated on the drawings shall be followed unless otherwise specified or agreed to by Consultants/consultant. Where change in direction of the cable is necessitated, the bending radius of the cable shall not be less than the diameter of the cable drum or 12-times the diameter of the cable which ever is greater.

At all road crossings the cables shall pass through 100/150 mm dia PVC pipes shrouded in cast concrete, the mouths of which shall be sealed with cable bitumen compound of approved quality after drawing the cable. The road cuts shall be first filled with mud and 50mm size ballast up to 182 mm level below the road surface and after ramming it properly 150 mm thick layer of cement concrete 1:3:6 shall be laid over it.

The cushion of sand to be provided in the trench before laying the cable shall not be less than 75mm and after laying the cable 150 mm. The total depth of cushion of sand shall be not less than 225 mm. Over the final layer of sand, cable marking tiles/bricks or concrete masonry blocks of adequate strength 2"-thick and 300mmx200mm in size shall be provided to the satisfaction of the Consultants/Consultant. The rest of the trench shall be back-filled with earth in 150mm layers and rammed properly before dressing.

All trenches and holes dug for laying the cables shall not be left open and unprotected for any length of time without completing the job and back-filling it to the satisfaction of the Consultants/Consultant. Where trenches are left open due to some unavoidable reasons the Contractor shall exhibit suitable danger signals such as banners, red flags and red lamps etc. etc.

All cables shall always be lead out or lead into the ground through 2.5-meter long G.I pipe of 75 mm dia. or size as approved by the Consultants/Consultant. The length of the pipe in the ground shall be 600mm. The pipe should be attached to the poles with approved clamps.

Markers of approved design and inscription shall be installed as specified.

For installation of cable in perforated metal trays, the cable shall be tied or bunched properly in an approved manner. Similarly for installation of cables on cleats or raceways approval of the Consultants/Consultant shall be obtained.

3.8 MEASUREMENTS

For the purposes of measurement this item shall be treated as actual lengths of cables installed in meters at site.

SECTION-4 UNDER GROUND TRENCH & LYING OF UNDERGROUND CABLES

4.1 Under Ground Trench

- A. The underground trench for the carrying of underground cables and wires through pipes, etc., shall be provided internally and externally as shown on the Drawings. While the routes for external runs are to be followed taking into account clearance from under ground sanitary and water supply pipe lines, etc., those required internally are dependent up to the type and size of equipment being installed in the substation and equipment rooms, etc., and hence this shall have to be specially modified on the basis of the requirements of the equipment manufacturers or suppliers.
- B. The layout and the design of the duct shall be approved by the ARCHITECT before actually commencing the work on it. All other trades shall have to be coordinated while deciding the alignment of underground trenches. The construction of the trench shall be totally water proof such that no seepage or leakage of water takes place either from top, bottom, or sides.
- C. The cables pipes shall be supported on two horizontally placed metal supports of 37mmx3/16 L iron and duly clamped at interval not exceeding 750mm. A covering of 3.8mm thick of soft but indestructible by heat material shall be applied to unserved cables. The supports shall be staggered as detailed in Drawings.
- D. The angle iron shall be buried in the trench masonry at the time of Construction.
- E. The trench shall be absolutely clean when the cable is laid.
- F. Suitable slope shall be provided in the floor of the trench the lowest point shall be connected to the drainage system so as to ensure self- drainage of water, if any.
- G. The trench outside the Building shall be water tight, and shall be covered by R.C.C. precast slabs. This shall further be covered by 37mm mortar for waterproofing.
- H. The manholes of the trench shall be kept open till cable is pulled in and positioned. Thereafter the trench shall be covered with RCC slabs and motor.
- I. Trench inside the building shall be covered with 6.5 mm thick, M.S. checkered plate.
- J. The manholes covers outside the building shall be of cast iron waterproof type of the size of openings indicated on the Drawings. The covers for the inside trench however, shall be of 6.50 mm thick-checkered plates.
- K. The CONTRACTOR shall arrange to provide for a watertight entry of cables where they enter the building. This shall be done by the use of cement concrete pipes provided one for each cable in a reverse slope and with bitumen filling of the end.

4.2 Laying Underground Cable

- A. The size of the trench to be excavated shall be 90mm in depth and 450mm in width for each cable to be laid. Where more than one cable is to be laid in the same trench, width of the trench to be increased by 150mm for each extra cable for size below 70mm² and 300 mm for bigger sizes.

- B. The cushion of sand to be provided both above and the below the cable must not be less than 100mm in depth, i.e., the total depth of sand shall not be less than 200mm. The sand shall be laid in trenches as under.
- C. After laying the cable in the trench 75mm of sand shall be put over the cable. The cable then shall be lifted and placed over the sand bed and the balance 125mm of sand put over it before filling. Where cable is laid in rocky situation extra thick cushioning as may be decided by the ARCHITECT shall have to be done without extra charge. Over the final layer of sand, C.C. Slabs 100mm thick and 300mmx 200mm inside of approved make shall be placed end to end along the whole length of the cable. As a protection from injury gives indication that a power cable is laid there. The rest of the trench shall be filled up with earth, which will be rammed in layers of 150mm each.
- D. In excavating a trench as direct a route as possible must be taken and will be decided by the ARCHITECT.
- E. Where it is necessary to divert the cable, the radius of the bend may not be less than twice the diameter of the cable drum or 20 times the diameter of the cable which ever is greater.
- F. Where trenches are left open overnight and where roads are being cut in the day or night, the CONTRACTOR shall exhibit suitable danger signals such as banners, red flags and red lamps at his own cost.
- G. If any damage is done, to the existing cables, etc., the cost of making good such damages or entire replacement shall be recovered from the CONTRACTOR.
- H. Road crossing, if necessary, shall be filled in and repaired with cement concrete in proportions of 1:3:6 (one cement, three sand and six ballast). The size of ballast to be used shall be 25mm. The finishing surface shall, however, comply with the specifications of the road.
- I. The road cuts and filling shall be filled up and suitably watered and cement shall not be laid until all subsidence stops and no time shall be lost in putting the cement concrete. Wet gunny bags shall be spared over it for a period of not less than three days order to allow full setting of the cement concrete.
- J. All the trenches shall be watered and rammed properly before final dressing. The same applies to lawns public or private but here in place of cement filling some manure of good quality shall be utilized. The turf shall be carefully rammed and preserved in a convenient place before excavation and shall be re-laid after filling up, watering and manuring is completed.
- K. The road cuts shall be filled up first with mud concrete in the proportion of 1:2, i.e., one mud and 2 ballast up to 150mm below the road level and after consolidating it properly 150mm below the road level and after consolidating it properly 150mm of concrete in cement shall be laid over it. But in the case of bitumen surface of road the top dressing are to be adjusted.
- L. No trenches shall be dug until the CONTRACTOR is certain that the cable is available for laying in it.
- M. Wherever cables are required to be installed inside a building or in any other masonry or channel work it shall be done neatly by use of cleats or any other devices as directed by the ARCHITECT.
- N. Cement concrete pipes or G.L.Pipes whichever is required shall be provided for all road crossing and nothing extra will be paid for these. The size of the pipe will be decided by the ARCHITECT and shall not less than 100mm in diameter for a single cable and not less than 150mm for more than one cable. These pipes will be laid direct in the grounds without any bed without pacca joint. No sand cushioning or tiles used in such situations.

- O. Cables shall always be laid out or laid into the ground through 200mm ling C.C.pipe of suitable size. Nothing extra will be paid for this pipe. A reasonable length of cable in the form of coil shall be left at ends of the under ground run of the cable for subsequent use.
- P. The CONTRACTOR should exercise great care in handling the cable and avoid forming kinks. The cable drum should invariably be conveyed on the wheels and the cables should be unrolled in right direction as indicated on the drum by the manufacturers.
- Q. After the cable is laid it will be tested by the ARCHITECT. If the test is unsatisfactory, the cost of all repairs and replacement and all extra works of removal and lying will be recovered from the CONTRACTOR.
- R. Filling of trenches shall be done after the sand cushion and lying of tiles is carried out to the satisfaction of the ARCHITECT. Where road berms have been cut or kerbstones displaced the CONTRACTOR shall repair all damages to the satisfaction of the ARCHITECT and all surplus earth or lock removed to a suitable dumping place, which will be indicated by the ARCHITECT. Where in the course of excavation lawns or roads have to be cut it shall be done under the supervision of the staff of the ARCHITECT and in such a way that the turf removed can be re-laid.
- S. When commencing work the material shall be collected at places which are out of way and out of sight of all traffic and after completion of material left over shall be removed without laying any unsightly patches on the downs and road berms. If this condition is not fulfilled the OWNER a shall get the work done by other agency and recover the cost form the CONTRACTOR.
- T. If any damage is done to any other services during the execution of the work and due to operation of the CONTRACTOR, the whole cost of making good such damage is excessive or deliberate, it shall amount to breach of the terms of this CONTRACT, the ARCHITECT may at his discretion take appropriate action at the cost of the CONTRACTOR.

.....End of Section.....

SECTION-5 SWITCHGEAR & RELATED EQUIPMENT

5.1 General

- A. All apparatus and equipment specified hereinafter in this section shall fully conform to current standards of BSS to the extent applicable to each type and class of equipment and apparatus described, and individually bear the seal of manufacturer.
- B. To the maximum extent feasible all such apparatus and materials shall be of one and the same manufacturer.
- C. The type, class, and catalogue number hereinafter stated and employed to establish the class and quality of apparatus and equipment required for this work.

5.2 Enclosures

- A. The enclosures shall be of M.S. sheet steel not less than 16 SWG dust protecting for all apparatus mounted inside the building.
- B. Ferrous parts of dust protecting type enclosure shall be adequately dust protected and shall be finished with a coat of paint stove dried and hardened.
- C. Weather proof type enclosure shall be provided with hot dip galvanized coating complying with BS 729. A decorative finish is not required.
- D. Provision for locking shall be provided unless specifically asked by the ARCHITECT not to provide.
- E. Fixing holes in the dust protecting type enclosure may be inside or outside the enclosure. Weatherproof type enclosure will have external fixing lugs.

5.3 Bus- Structure

- A. Bus- bars shall have 98% conductivity, round edge, silver plated copper sized 2000 Amps per 25 mm² and shall be braced for 50,000 amps RMS symmetrical short circuit current.
- B. Bus shall be mounted on supports of high impact, non- tracking insulating material.
- C. Provide a full- length ground bus in the rear of each cubicle.

5.4 Metering Equipment

Where mentioned on the Drawings provide material as detailed below.

- A. One 112.5mm square 1% accuracy 250 degree indicating scale voltmeter having 0-500 volts scale.
- B. One seven position voltmeter selector switch, 1-2,3-3,3-2 1-N, 2-N, 3-N and OFF.
- C. One 112.5mm square 1% accuracy 250 degree indicating scale ammeter having required scale. Use 3 ammeters if asked.
- D. One flush type ammeter selector switch, 1,2,3 and OFF.
- E. Three required ratio current transformers

5.5 Circuit Protective Devices

A. Molded Case Circuit Breaker

Molded case circuit breakers shall be panel mounted having not less than 25,000 amps RMS symmetrical short circuit capacity. Trips shall be standard dual magnetic type or solid-state type with built in ground fault sized as shown on the Drawings. Except where shown specifically breakers shall be manually operated

B. Miniature Circuit Breakers

The miniature circuit breaker shall have built in over load and short circuit protection mechanism. The unit shall be suitable for rupturing capacity of 2,500 amps RMS and 2,000 switching operations.

C. Fuses

All fuses shall be totally sealed, HRC, complying fully with BS-88 for BS-11361. The fuses shall have category duty of AC-46 and fusing factor of Q-1. Where fuses are used in machine have fusing factor of Q-2 Where fuses are employed to provide back up protection to mould case or miniature circuit breakers their rating at particular point shall suit the short circuit level.

These will have standardized to five module types (in the pursuit of ever easier operation and allowing denationalization and standardization of the panel design), panel cutout design unified to include 30- 800A frame, cassette-type accessories (it provides flexibility when upgrading circuit), improved performance and safety (PSS-II) because of IEC60947-2 compliance, rated service short circuit (Ics) will be equal to 100% Icu Utilization category 'B' (it is regulation on application with respect to selectivity), Standardized as suitable for isolation and dispatching,

Class –II insulation, IEC-664 (double insulation to make it safer than ever), digital current evaluation delivers a higher level of protection (Safer and more reliable power), standard pre-alarm system lights LED and output signal (Alarm function monitors and anticipates interruptions), coordinated protection form multiple (6) tripping characteristics improved protection against fluctuations in the load current), Neutral pole overload protection for 4-wire electronic circuit breakers (improved protection and safety), portable tester facilitates checking and maintenance (i) Long –delay tripping,(ii) Short- delay tripping, (iii) Instantaneous tripping, (iv) Pre-alarm Characteristics).

(These standards and specifications will be same as those of M/s Mitsubishi Electronic Co. and M/s ABB).

5.6 Circuit Breaker Combination Starters:

Circuit breaker combination starter shall be as follows:

- A. Full draw-out (plug-in) type (except load terminals) made in standard modular sizes so that a starter from one motor control center can be moved to another motor control center without modification. It will not be necessary to remove control wiring from terminal blocks to withdraw the starter unit.
- B. Circuit breakers in combination with the motor starters shall be of the high interrupting capacity type having a minimum interrupting ability of 14,000 amps RMS symmetrical at 380 volts. Circuit breakers shall contain an auxiliary switch to disconnect control power when breaker is turned OFF.
- C. Overload relays shall be provided in each let of the starter. Operation of the 'Reset' button will not cause the starter to drop out.

- D. Each starter shall be wired for a control voltage of 220 volts.
- E. Starter operating coils shall be pressure molded hermetically sealed so that they will not bubbles, melt or extent and so that they will not prohibit the starter form dropping out upon coil failure.
- F. Each starter shall be provided with 220 volts, red running pilot light, and a hand-off automatic or start- stop push button as required. Pilot light will be operated by an interlock contact on the starter placed across the operating coil.
- G. In addition to the 'Holding Interlock' and the pilot light interlock, each starter shall contain two extra auxiliary interlock. These interlocks will be capable of being covered to normally open or normally closed in the field.
- H. Each starter shall be provided with a black luminous nameplate with 3.8mm high white letters engraved to identify served.

5.7 Disconnect Switches

The disconnect switches shall be iron clad with or without fuse as noted. The switch shall be heavy-duty double isolation quick make. Quick break and provided with padlocking arrangement. Disconnect switches shall be provided at each motor that is out of sight.

5.8 Motor Control Centers

- A. Motor control centers shall be combination fuse/circuit breaker and starter type of the size and rating as shown on the Drawings and shall be designed, tested and assembled in accordance with NEMA or BSS standards.
- B. The enclosures shall consist of standard modular cubicles bolted and bussed together to form a rigid, structure having the following features in each cubicle, top and bottom lateral wiring pull boxes, one vertical wire way per vertical grouping of starter, capability making the addition of future cubicles by simply bolting on a new cubicle and making the addition of simple splice plates to the main bus. All doors shall be formed up on all sides and shall be equipped with captive screw fasteners and concealed hinges.

Bus structure shall be as follows:

Silver-plated, 89% connectively copper with provisions for coordination with incoming cables as indicated on the Drawings.

- Bracing shall be good for fault level of. KA.
- Bus bars shall be supported on high impact, non-tracking insulating material.
- A ground bus shall be provided across the bottom of the cubicle.
- Horizontal bus shall be rated for amps specified for each MCC and shall be braced To withstand short circuit stresses of. Amps RMS symmetrical at 380 volts.
- Bus shall be sized to limit temperature rise to 50 degree above a 40 degree C Ambient with maximum current density of amps per 25 mm square.
- Bus shall be carried with fiberglass to protect for arcing fault to ground conditions.

These standards and specifications will be those of M/s Syed Bhai Electric Company, M/s PEL, M/s Siemens Consultantsing Co. or as given in the related items of BOQs or as approved by the Consultants /Consultant

5.9 Appliances, Plugs and Sockets General Purpose

For certain portable appliances and prepared machines, socket outlets and plugs are to be provided and installed as per detail in Drawings and BOQ.

These socket outlets and plugs shall be wall mounted suitable for 240/415 volts, single phase of three phase Neutral + Earth with interlocked switch, made of castration; the rating shall be as per design Drawings requirements.

.....End of Section.....

SECTION-6 DISTRIBUTION BOARDS.

6.1 GENERAL

The distribution boards shall be free standing, cubicle type or wall mounting type suitable for surface and/or recessed mounting. Each distribution board (D.B.) shall be tropical in design, fully dust and vermin proof and liquid repellent. The cabinet housing the main components shall be fabricated from mild steel sheets 16 SWG thick and reinforced with structural steel members welded to it. Front access, mechanically locked and hinged doors, fully gasketed, having one or two leaves depending upon the size of the cabinet shall be provided on each Cabinet. All open-able parts shall be provided with gaskets or lining and screwed to the main body with chromium plated screws. The cabinets after fabrication shall be thoroughly cleaned completely de-rusted and greased before applying one coat of zinc or lead- based primer and then two coats of top quality synthetic emulsion or stove enamel paint in battleship grey colour. All exposed parts of the DBs shall be covered with 5mm thick Bakelite sheet. A load distribution chart shall be provided in each DB showing the areas fed by each circuit and a suitably sized pocket inside the front door shall be provided for the purpose. Each DB shall be delivered complete with all instruments accessories, rating plates, designations, as approved by the Consultants/Consultant.

Suitable cable entry glands shall be provided as required for floor mounted boards on the incoming cables but for outgoing cables and/or wall mounted boards exact number of conduit entry holes as are required shall be provided with male brass bushes. The bushes shall be tin-plated and fully shrouded or housed in gasketed compartments.

6.2 COMPONENTS

The Main components e.g. Moulded case circuit breakers, load break switches, HRC fuses and instruments that are required for DB's as shown on drawings and as described in schedule of quantities (BOQ's) shall be the same as described in the related section However miniature circuit breakers (MCBs) used in DB's are briefly described hereunder:-

6.3 MCBs

The incoming shall have triple pole MCB's suitable for use on 415V 50 Hz, AC and the outgoing MCBs shall be single pole or single phase for use on 220V, 50 Hz, AC. The ratings are as shown in drawings and/or described in the Schedule of Quantities (BOQ's).

The MCBs shall be moulded case type having hydraulic magnetic short circuit releases, contacts, operating mechanism and arcing chambers.

The MCBs shall be manufactured and tested to BSS 3871/1966, and shall have a rupturing capacity of 7.5 KA. The final circuit MCBs, on the outgoing, shall however be rated 5KA. The MCBs manufactured by Clipsal, Marlin & Gerin France or Mitsubishi Japan or as approved by the Consultants/Consultant. The Distribution Boards shall be manufactured by as approved manufacturer.

6.4 INSTALLATION INSTRUCTIONS

All labour, equipment, tools, plant and accessories, required to complete the installation, shall be provided by the Contractor. The distribution board shall be fixed as required in perfect line and plumb. All incoming and outgoing cables shall be terminated properly. All earth terminations shall be made on the neutral block.

6.5 TESTING

All DB's shall be tested at manufacturer's works and tests, shall be witnessed by the Consultants/Consultant without incurring any additional expense to the Owner.

6.6 MEASUREMENTS

Each distribution board for the purpose of measurement shall be treated as a lump sum job.

.....End of Section.....

SECTION-7LIGHTING FIXURES

7.1 General

- A. The lighting fixtures are described in the Bill of Quantities/ Drawings with a particular manufacturer's catalogue number. The fixtures to be offered shall be either of the original manufacturer of whom the catalogue number is quoted or alternatively can be of any other standard manufacturers, but strictly complying, as regards the shape quality, grade of material used and the workmanship to that of the original manufacturers.
- B. The ARCHITECT shall have the absolute right to judge for approval or rejection the quality and shape of fixture for which the Tenderer shall have to submit samples for approval before commencing on the bulk procurement. Action taken for bulk procurement of light fixture prior to final approval shall be entirely at the risk of the CONTRACTOR.
- C. The tenderer shall have to specifically mention the name of manufacturers of different types of light fixtures, which he is offering and shall become bound to supply fittings of the same manufactures.
- D. The lighting fixtures are to be installed indoors or outdoors, and are to be treated suitable for installations and use in the corresponding situation.
- E. All pendant fixtures shall be supplied with required wiring material and down rods for hanging at the height specified along with complete hardware for suspension. Similarly, all bracket fittings are to be supplied with wiring leads and the required fixing hardware.
- F. All lights fixtures are to operate on the single phase 230 volts, 50 cycles, alternating current mains supply. A fluctuation of 10% on this declared voltage has to be tolerated and therefore the starting gears to be furnished, particularly with the discharge type of lamps and tubes, has to be of suitable characteristics.

7.2 Incandescent Lighting Fixtures

- A. The fixtures shall comprise of the metal part including the lamp holder, with aluminum cylinder with stove enameled paint, the glass
- B. of the heat resisting grade or the opal plexiformed material, fixing or hanging attachment with necessary hardware and connecting wiring leads, etc; requiring coeternal material for their installation.
- C. The glass used throughout shall be opal with an absorption factor of 15%
- D. All pendant fixtures shall have suitable canopies constructed of sheet steel stove enameled.
- E. All ceiling mounted fixtures shall have suitable gallery constructed of heavy gauge sheet metal work with stove enameled white finish.
- F. All screws to be used shall be with counter sunk heads, brass, chromium plated of the required gauge.
- G. The flexible wires to be used for the purpose of connecting the fittings with the permanent wiring shall be rounding, similar to Pakistan Cables Ref. No. 09193 Y White in colour with a minimum size of 23/ 0076" wherever the wire is exposed for hanging the pendant fittings and is to take the load of the fittings. The third core to be connected to the earth terminal of the fittings of fixtures. Wherever the wires are to pass through the metal rod or in a bracket fittings, the wire used shall be similar to Pakistan Cables Ref. No. 98182Y.

- G. Holders used throughout shall besides being suitable for respective type of service shall be of brass with porcelain inside or screw type porcelain lamp holder for pressed glass lamp.
- H. The light fixtures and other lights to be installed in humid areas or externally as per schedule of quantities/Drawings shall be constructed of heavy gauge non ferrous metal and of water proof, whether treated type. The tenderer shall have to specifically mention the special applications employed to achieve the above requirements.

7.3 Fluorescent Lighting Fixtures

- A. The fixtures shall comprise of the metallic enclosure, reflectors, diffusers or louvers, high power factor ballasts or choke with matching capacitors, holders, starters, starter bases, fluorescent lamps and complete hanging attachment with suitable canopies.
- B. The metallic enclosures shall be constructed of heavy gauge mild steel sheet metal, power pressed to form the desired shape. End plates, etc., to be riveted or welded and properly finished after the respective operation. The enclosure shall house the lamp gears and shall have proper ventilation.
- C. The metallic reflector shall be constructed of heavy gauge mild steel sheet metal work and shall be fixed to the enclosure with adequate number chromium plated screws. The reflector shall be machine pressed to the required shape.
- D. The entire metal works shall be stove enameled white finish inside and outside, through surface making and finishing.
- E. The diffusers shall be either transparent or opal plexi material with absorption factor of below 15% minimum, 3.8mm thick and of uniform design and sturdy construction of the shape and type as per schedule of Quantities /Drawings. The fixing arrangement of the diffusers shall be such that it is quickly detachable for the purpose of replacement of lamp, etc.
- F. The louvers shall be of unit construction type, molded from semi flexible plastic material under high pressure, opal colour, diamond cut and sturdy in construction. The cutting of the unit shall be at the diamond corners, so as to leave complete diamonds at the end or M.S. sheet metal louvers.
- G. The ballast shall be of high power factor type of a combination of choke with matching capacitors; both rated for the type of lamps to be connected to. The ballast shall conform with regard to the General construction, creep age distances and clearances, high voltage test, temperature rise and endurance as well as the noise level to the relevant standards of B.S.S 2818 part- 1:1962. The capacitors, if separately installed, shall comply with the standards of B.S. 4017.
- H. The fluorescent tubes shall be of Bi- Pin type 37.5mm dia. of the length and wattage specified in the Bill of Quantities/Drawings. These shall be "cool White" or "Day Light" in colour as required. The types shall comply in every detail with B.S. 1853: 1960.
- I. The lamp holders and bases for the starters shall be of bakelite, complying strictly to B.S. 1875.
- J. The fluorescent lamp starter shall be of capacitor type suitable for the respective size of lamp and complying strictly to the provisions of B.S. 3772
- K. All wiring for connecting various gear of the fitting shall be suitably clamped. The ends shall be soldered and terminated in a 2-way porcelain connector. The wire used shall be 23/ 0076 similar of Pakistan Cables Ref. No. 09183Y.
- L. The load current per 40-watt fluorescent tube shall not exceed 0.46 amps on 230 volts, 50 cycles, and main supply.

- M. The manufacturers shall of the size and shape generally recommend suspension rods and canopies. The rods shall be of minimum 12.7 mm size light seamless pipe of 16 gauge thickness and canopy fabricated from heavy gauge sheet in power press Both shall be stove enameled white after through surface making and clearing.
- N. The fixtures required to be installed in location where acidic fumes or to her gases encouraging the corrosion may be present, shall be provided with the fittings of corrosion resistant construction employing all white PVC sheet and black nylon covers.

Fluorescent light fittings and fixtures will be electro-galvanized steel body, fully powder coated with pyrite's exclusive pier white. Ripple edge to the body to avoid cut fingers and increase protection against corrosion. Rolled edges to large cable tray. Large terminal block positioned to give easy access for termination. 2 Nos ballasts in twin tube models at one end for faster wiring. Replaceable lamp holders' quality approved ballast, capacitor, starter lamp holders and cable and captive cover plate screw.

Lamp holders packed inside batten, snap- lock into position without tools. It will be fast, fool-proof operation with no additional wiring required. Diffuser will be linear prismatic type will have 604 mm (Pin to pin) length and diameter 26mm, current 0.36 amps, voltage 59 volts and power 18 watts. Whereas for 36 watts, length 1204. 1mm and diameter 26mm, current 0.44 amps, voltage 103 and power 36 watts.

Color temperature (K) and colour renderings will be 4300 K, 6200 K (max) 75 for cool white and day light colours respectively.

For 60mm GLS, E27 OR B22 caps 240 volts clear or pearl lamp maxi length for E27 = 104 MM + 3mm (for E22 = 102.5mm + 3mm) and maxi diameter for E27/B22 will be 60mm +1mm. For main roads etc. lights will have Highly utilization factor, good glare control, IP65 protection class for lamp compartment prevents ingress of moisture and dust, easy access to glare tray, the bowl is kept in position by means of 3 clips, hence accidental opening of the diffuser bowl will be impossible and SABS 1277 mark (Bekasun and Bekalux). For Parks and pubic area, the light will have IP55, SABS 1277 standards, corrosion resistant, robust top cover, easy maintenance, housing incorporates all electric gears and will be provided as wall- bracket or post- top fitting (Beka Ray). For Façade/Flood light, the light will have asymmetric IP65 for high intensity discharge lamps, die-cast aluminum body, 99.9% pure aluminum reflector, anodized and polished for greater reflectivity, PG 13.5 Nylon gland, lamps holder and wiring to BSS, tempered glass for thermal shock resistance, adjustable aiming angle, asymmetric reflector, approved by CE1-34-21, EN60598-1 and protection IP657.

7.4 Battery Operated Emergency Lights

The unit shall be combination of lead acid batteries, battery, charger, sealed beam lamp, electrical circuitry. During the normal course the batteries shall be under charging state. When the main power fails, the batteries shall discharge through sealed beam lamps. The changeover shall be instantaneous, the unit shall incorporated 2 Nos. 12 volts 35 amps/hour lead acid batteries solid state silicon controlled battery charger with monitoring circuit, indication lamps showing following conditions.

7.5. Charge – Power – Test – Lights

The unit shall have two lamps of 12 volts, 45-candle power sealed beam type mounted on swivel neck necessary wall mounting bracket, remote connection cord and 5A 3 pin plug.

The unit with all its components shall be guaranteed for safe and useful life of minimum 12 months.

7.6. Ceiling Fans and Exhaust Fans

These will be best in quality and durable in design, totally enclosed capacitor type motor, insulation quality as required by our extreme weather conditions, available with indication type regulator and dimmer switch, available in sizes 36", 48", 56" and 60"

For exhaust fans, these will be designed for the worst conditions, totally enclosed condenser motor, safety guard and blades.

These standards and specifications will be same as that of M/s GFC fans, M/s Pak fans, M/s Millat Fans and M/s Royal Fans etc.

.....End of Section.....

SECTION-8 EARTHING SYSTEM

8.1 General

All exposed conductive non-current carrying parts of the installation, comprising of conduit, switchgear, junction boxes, cable trays, etc., shall be efficiently earthed. Where the installation is supplied by a privately owned transformer or where the supply is obtained from the private generating plant in such a way that there is no metallic connection with the commercial public supply, the star point of the transformer or the generator shall be effectively earthed.

Earthing of non-current carrying conductive parts shall be independent of the earthing of star point of transformer or the generator.

The earthing shall be done to comply with the following regulations:

- A. Electricity Rules 1937 as adopted in Pakistan.
- B. Chapter 54 "Earthing Arrangements and Protective Conductors" of the IEE London Wiring Regulations 15th Edition.
- C. British Standard Code of Practice CP 1013- 1965.
- D. The specifications given hereinafter.

The earthing arrangement shall be such that:

- The value of resistance from consumers' main earthing terminal to the earthed point of supply is in accordance with the protective and functional requirements of the installation and expected to be continuously effective.
- Earth fault current and earth leakage currents likely to occur are carried without danger, particularly from Thermal, Electro-Mechanical and Thermo-Mechanical stresses.
- They are adequately robust or have additional mechanical protection appropriate to the assessed conditions of external influences.
- Necessary precaution is taken against the risk of damage to another metallic parts through electrolysis.

8.2 Earth Electrodes

The following types of earth electrodes are recognized unless otherwise called in the Bill of Quantities for the purpose of earthing.

- A. Earth rod
- B. Earth tapes or wires
- C. Earth plates
- D. Earth electrode embedded in foundation
- E. Metallic reinforcement concrete
- F. Metallic pipe system other than metal work of public gas and water services.

Lead sheaths and other metallic covering of cables not liable to deterioration through excessive corrosion; provided that the consent of the owner of the cable is obtained and suitable arrangements exist for the owner of the electrical installation to be warned for any proposed change to the cable that might effect its suitability as an earth electrode is also acceptable as earth electrode wherever the earth plate is specified as earth electrode.

The work shall include excavation of the pit in the soil of the SITE at least 30m away from the Building structure, refilling the pit with earth, lime and charcoal, watering, consolidation, and ramming of the layers to full compaction.

The earth plate other than for transformer or generator star point earthing shall be 60x60 x 5mm copper plate buried in the ground at a depth of 5m or less according to moisture in this strata.

Different earth electrodes shall be located 10 meter apart so that resistance shall not overlap the earth electrodes for transformer or generator star point shall be of size indicated in the Bill of Quantities. The earthing connection shall distinctly bear indication "Not TO DISCONNECT"

8.3 Main Earthing Terminal

In the installation of main earthing terminal or bar shall be provided to connect the following conductors to earthing conductor.

- A. The circuit protective conductor
- B. The main bonding conductor
- C. Functional earthing conductor

The main earthing terminal shall be cast and machined in electrolytic copper

The size of terminal shall be 300 x 100 x 10mm. The terminal shall be suitable for connecting two sets of earthing conductor and 10 or more protective conductor. Suitable number of brass bolt terminal shall be provided for terminating earthing conductor, protective conductors, and sheathing of armored cables.

Provisions shall be made in an accessible position for disconnecting the main earthing terminal from the main of earthing to permit measurement of the resistance of the earthing arrangement. The joints shall be such that it can be disconnected only by means of a tool, and shall be mechanically strong.

8.4 Earthing Conductor

The connection between earth terminal and earth electrode shall be made by means of earthing conductor. The earthing conductor shall be of size indicated on the Drawings or Bill of Quantities, of soft annealed electrolytic copper. The earthing conductor shall run in G.I. Pipe or huge pipe of specified size as far as it runs in ground till it enters sub-station or electric room where it shall be fixed on saddles and supports.

The upper end of the jump pipe or G.I. pipe shall terminate in a main hole so as to inject water for lowering the earth resistance as and when necessary. There shall be no joint in earthing conductor between the earth electrode and earth terminal.

The shortest route of the earthing conductor shall be adopted, but sharp bends and joints in all cases shall be avoided. The joint between earthing conductor and earth terminal shall be made by means of sweating sockets, brass nut and bolts and double washers so fixed to make a permanent and positive connection with the earth electrode.

8.5 Testing.

The earth electrode resistance shall be tested for effectiveness of earthing. The test shall be carried out by means of earth tester; the maximum continuity resistance from any point in the installation including earthing conductor to the earth electrode shall not exceed 1 Ohm. The CONTRACTOR therefore, must ensure that earthing conductor are efficiently bonded to all metal works other than the currents carrying parts so that the above resistance limit is not exceeded. The testing shall be carried out as per procedure laid down in the regulations for Electrical installation 15th Edition.

8.6 Lightning Protection System

The system of lightning protection shall be installed so as to protect the building against lightning, conforming to B.S.S. code of Practice C.P. 326.101 of 1948 (hereinafter referred to as C.P.326.101) as per Drawing.

The installation shall comprise of the following:

- A. Network of Air terminations.
- B. Bonds
- C. Roof Conductors
- D. Down Terminations
- E. Earth Terminations
- F. Testing Points

There shall be air termination points on the building installed 100mm above the finished floor levels as per Drawings. The air termination shall be cast and machined in electrolytic copper, conforming to B.S.S 1400, as per Drawings. The air termination shall be complete with single pointer, rod as per Drawings. The rod shall be of high tensile brass bar, conforming to B.S.S. 251C (Grady). The air termination shall be reinforced, so as to withstand the excessive pressure of air during storms.

The bends roof conductor shall be of soft annealed electrolytic copper strips 1" x 1/8" conforming to B.S.S. No. 899.

The down conductors shall be of a soft annealed, electrolytic copper strip 12mm x 3mm, conforming to B.S.S. 899. There shall be two down conductors for each building as per Drawings. Each down conductor shall be equipped with independent testing points, earth termination lead and earth.

The earth termination lead shall be of soft annealed, electrolytic copper strip 12mm x 3mm conforming B.S.S 899.

.....End of Section.....

SECTION-9 TELEPHONE SYSTEM

9.1 General

- A. The telephone installation include the following items:
- Supply and installation of telephone system comprising of steel conduit telephone channel, pull boxes, junction boxes, terminal strips and cabinets.
- Supply and drawing of telephone cables, testing and making connections, subject to the approval of T & T Department of Pakistan.
- B. The work shall be carried out in accordance with the Electrical Code of practice CP 327-101, OP 327-102 of England and to the entire satisfaction of the Telephone Department of Pakistan and ARCHITECT.
- C. The main jumper stand in PDBX Rectifier, Telephone Exchange Equipment and telephone instruments, telephone cables, will be supplied and installed by the Telephone Department of Pakistan or by nominated supplier of the OWNER.
- D. The earth continuity shall be maintained through out the telephone installation. An earth terminal in the pull- out box shall be used to feed earth continuity to telephone instruments. The earth continuity wire will be 14 SWG HDDB.

9.2 Telephone Junction Cabinet

- A. The junction cabinets shall be metal clad, made of safety dead front flush types, cubical design with hinged doors, built in concealed locks.
- B. The cabinets shall be designed for easy access, services and replacements.
- C. The cabinets shall be made of heavy 16 SWG mild steel metal with standard concentric knockouts all around at suitable places. The doors of all the cabinets shall be keyed alike.
- D. The cabinet shall be proofed against ingress of vermin. The cabinet shall be designed to accommodate connecting terminals with indicating and marking arrangements. It shall be equipped with terminal as shown in BOQ.
- E. The cabinets shall be equipped with PVC molded terminal strips and the screws shall be made of dull chrome plated brass.

9.3 Telephone Cables

- A. The telephone cables shall be installed indoor in conduit, under floor trucking, and outdoor in G.L. pipe and shall be designed and built to give efficient and reliable service continuously at the normal voltage, current and audio frequency ratings in the climatic and atmospheric conditions prevalent at SITE.
- B. The telephone cables shall be indoor, PVC insulated complying with B.S.S. 2746 and sheathed. It shall be possible to connect the conductors directly to the equipment circuit or through strip connector housed in the junction boxes and cabinets. The cables shall be multi-pair as per Drawings and schedule of Quantities.
- C. The conductors shall be of annealed high conductivity tinned copper, diameter 0.6mm weighing 2.7Kg/km PVC covered, nominal wall thickness of 0.2mm, wires twisted to pairs.
- D. The conductor diameter 0.6mm at temperature shall have the following characteristic:

Maximum loop resistance	13ohms/K.M.
Minimum insulation resistance	100 Meg. Ohms/K.M.
Mutual Capacity	160MF/K.M.
Test voltage	300 volts A.C.
Operating voltage	60 volts DC.

- E. The cable shall be drawn in the conduit or under floor trucking in accordance with the telephone layout Drawings. All wires shall be continuous between the telephone outlet, junction boxes, and junction cabinet, junction posts and between junction boxes, as applicable in accordance with the Drawings.
- F. All connections shall be made, marked and identified on the terminal strips provided in the junction boxes, cabinets and the posts.
- G. 2-METER length of cable beyond the rubber grommet shall be provided at each telephone outlet to facilitate connection of telephone instruments.
- H. Unless otherwise particularly approved, no wire shall be pulled in until the conduit and trucking system is completed. No grease, oil or lubricant other than powered soapstone shall be used to facilitate the pulling of wires.

All the accessories that will be used in telephone, intercom and computer systems will have same standards and specifications as that of M/s Motab Co. and M/s Sysnet Co. or as approved by the Consultants/Consultant

.....End of Section.....

SECTION-10CABLE TRAY

10.1 Specifications & Fixing

The cable tray shall be made of SWG heavy gauge G.I. Sheets of various sizes as shown on the Drawings and mentioned in schedule of quantities with perforations for ventilation. The cable tray specially cutted ends and perforations shall be treated with three coats of anti corrosion paint " Barhakey" form M/s. BERLAL A- G Sissah / Switzerland or approved equal paint available local, also two coats of enameled paint colour to be selected by the Consultants/Consultant.

Complete with suspension system hangers, rod, nuts, bolts, etc., the cable tray shall be without covers in whole Building, and with covers when cable tray in running vertically.

Code and IEE regulations and cable tray from floor to floor or one section of the building to the other section of the Building should be sealed with fireproof material. Cable trays and accessories will be completed in all respects and to entries satisfaction of Consultants/Consultant.

.....End of Section.....

11.1 GENERAL

Upon completion of the installation the Contractor shall perform field tests on all equipment, material and systems. All tests shall be conducted in the presence of the Consultants/Consultant for the purpose of demonstrating equipment or system compliance with specifications.

The Contractor shall furnish, install and maintain all tools, instruments, test equipment, material, connections, etc. and furnish all personnel including supervision and "Standby" labour required for the testing, setting and adjustment of all electrical facilities and their component parts, including putting the same into operation.

All tests shall be made with the proper regard for the protection of the equipment, and the contractor shall be responsible for adequate protection to all personnel during such tests.

The Contractor shall record all test values of the tests made by him on all equipment, giving both 'as found" and "as Left" conditions. Three (3) copies of all test data shall be given to the Consultants/Consultant for record purposes.

The witnessing of any test by the Consultants/Consultant do not relieve the Contractor of his guarantees for materials, equipment and workmanship as specified in the Conditions of Contract.

11.2 INSULATION TESTS

Insulation resistance tests shall be made on all electrical equipment, using a self- contained instrument such as the direct indicating ohmmeter of the generator type. Direct current potentials shall be used in these tests and shall be as follows: -

Circuit under 230 volts -500 volts test.

Circuit 230 volts to 400 volts-1 000 volts test.

The minimum acceptable insulation resistance value will be 5 Mega ohms. The Contractor will furnish the test equipment for insulation testing.

Before making connections at the ends of each cable run, the insulation resistance test of each cable shall be made. Each conductor of a multi-core cable shall be tested individually to each other conductor of the group and also to earth. If insulation resistance test readings are found to be less than the specified minimum in any conductor, the entire cable shall be replaced and the new cable tested.

All transformers, and switchgear shall be given an insulation resistance measurement test to ground after installation but before any wiring is energized. Insulation tests shall be made between open contacts of circuit breakers, switches and between each phase and earth.

If the insulation resistance of the circuit under test is less than that specified above, the cause of the low reading shall be determined and removed. Corrective measures shall include dry-out procedure by means of heaters if equipment is found to contain moisture. Where corrective measures have been necessary and the insulation resistance reading taken after the correction has been made it should satisfy the requirements specified herein. Repeated insulation resistance maintenance test shall be made twice and at least 12 hours apart. The maximum range for each reading on the 3 successive tests shall not exceed 20% of the average value. After all tests have been made successfully, the equipment shall be reconnected.

Alarm system, telephone system, sound distribution system shall be checked and tested as per manufacturer's instructions and in the presence of the Consultants Incharge/Consultant.

Each resistance tests shall be made by the Contractor on the earthing system, separating and reconnecting each earth connection as may be required by the Consultants In-charge. If it is indicated that soil treatment or other corrective measures are required to lower the ground resistance values, the Consultants In-charge/Consultant will determine the extent of such corrective measures.

The electrical resistance of the ECC together with the resistance of the earthing lead measured from the connection with earth electrode to any other position in the completed installation shall not exceed one ohm.

Earth resistance test shall be performed as per Electrical Inspector's requirements. Where more than one earthing sets are installed, the earth resistance test between two sets shall be measured by means of Resistance Bridge Instrument. The earth resistance between two sets shall not exceed one ohm.

11.3 TRANSFORMER SWITCHGEAR

In addition to the Insulation resistance tests on the transformer, a polarity or phase rotation test shall also be made. Auxiliary devices, breather, Bucholz relay etc. shall be tested for satisfactory operation.

Each air circuit breaker shall be operated electrically and mechanically, ascertaining that handle mechanisms are operating. All interlock control circuit shall be checked out for proper connections in accordance with the wiring diagrams given by the manufacturer.

Series over-current trip elements shall be checked against rating of equipment served. Also to be checked for correct size, function of fuses, disconnect switches, number of inter locks, indicating alarms and remote control devices. Nameplates shall be checked for proper designation of equipment.

11.4 OPERATING TESTS

The load measurement shall be made on equipment and on all power and lighting feeders.

The current reading shall be taken in each phase wire and each neutral wire while the circuit or equipment is operating under actual load conditions. Clip-on ammeter may be used to take current readings. All light fittings shall be tested electrically and mechanically to check whether they comply with the standard specifications. Fluorescent light fittings shall be tested so that when functioning properly no flickering is observed or choke noise is heard.

The lightning protection system shall be tested for earth resistance and for electrical and mechanical joints. The combined resistance to earth to the whole lightning protection system shall not exceed 5 ohms.

The alarm system, telephone system, sound distribution system shall be checked and tested as per manufacturer's instructions and in the presence of the Consultants/Consultant.

After any equipment has been tested, checked for operation etc., and is accepted by the Consultants/Consultant the Contractor shall be responsible for the proper protection of such equipment for assurance that subsequent testing of other equipment of systems do not disturb the completed work.

End of Section

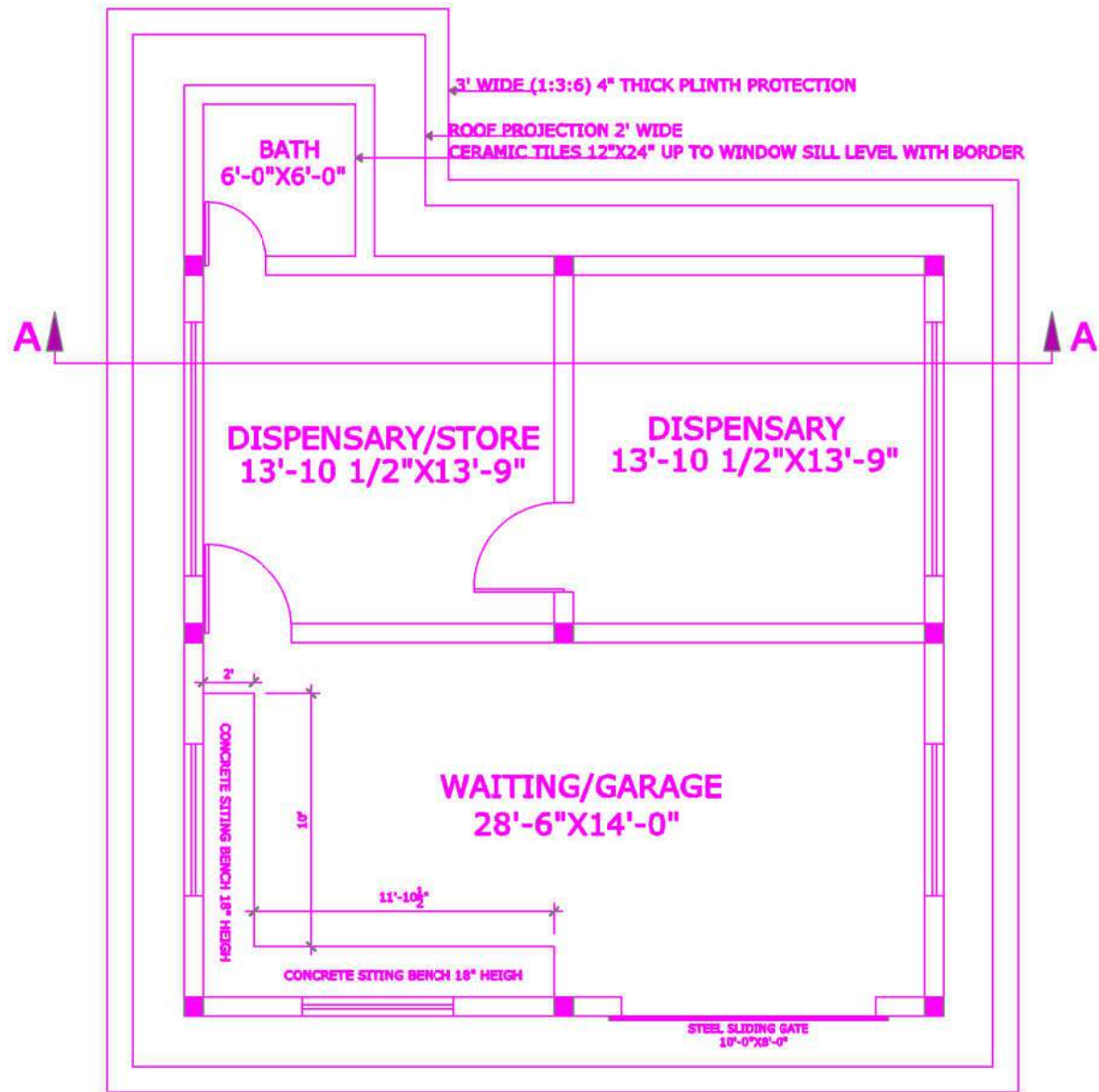

CONTRACTION OF DISPENSARY AT RHC DHUMAN
DISTRICT CHKWAL

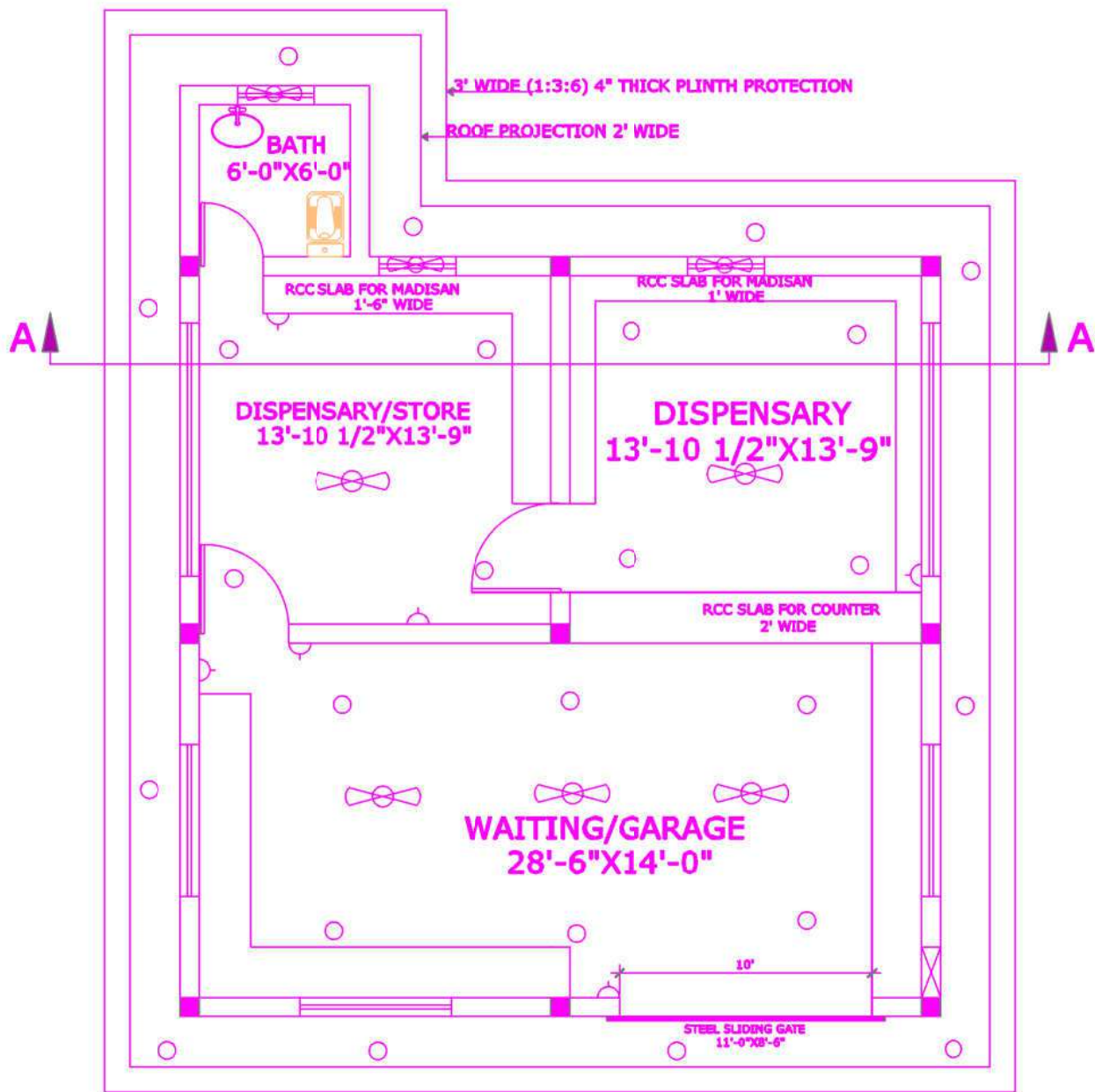

**CONTRACTION OF DISPENSARY AT RHC DHUMAN
DISTRICT CHKWAL**

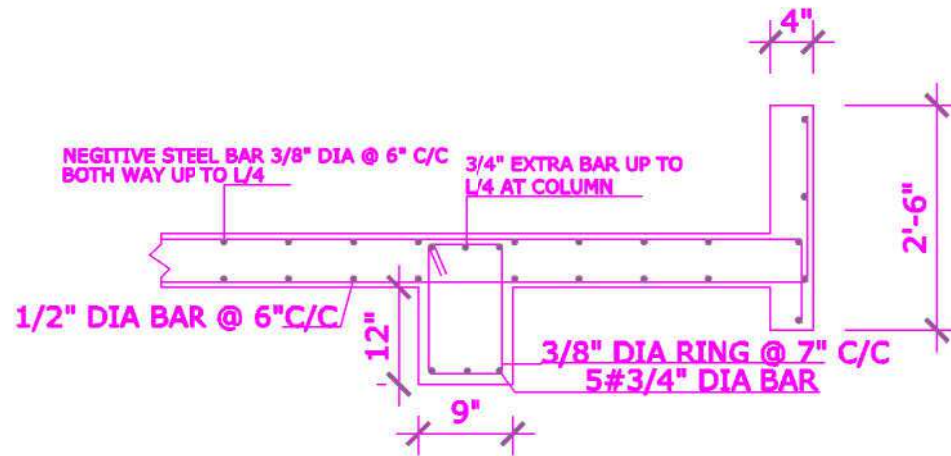

X-SEC OF ROOF BEAM AND SLAB

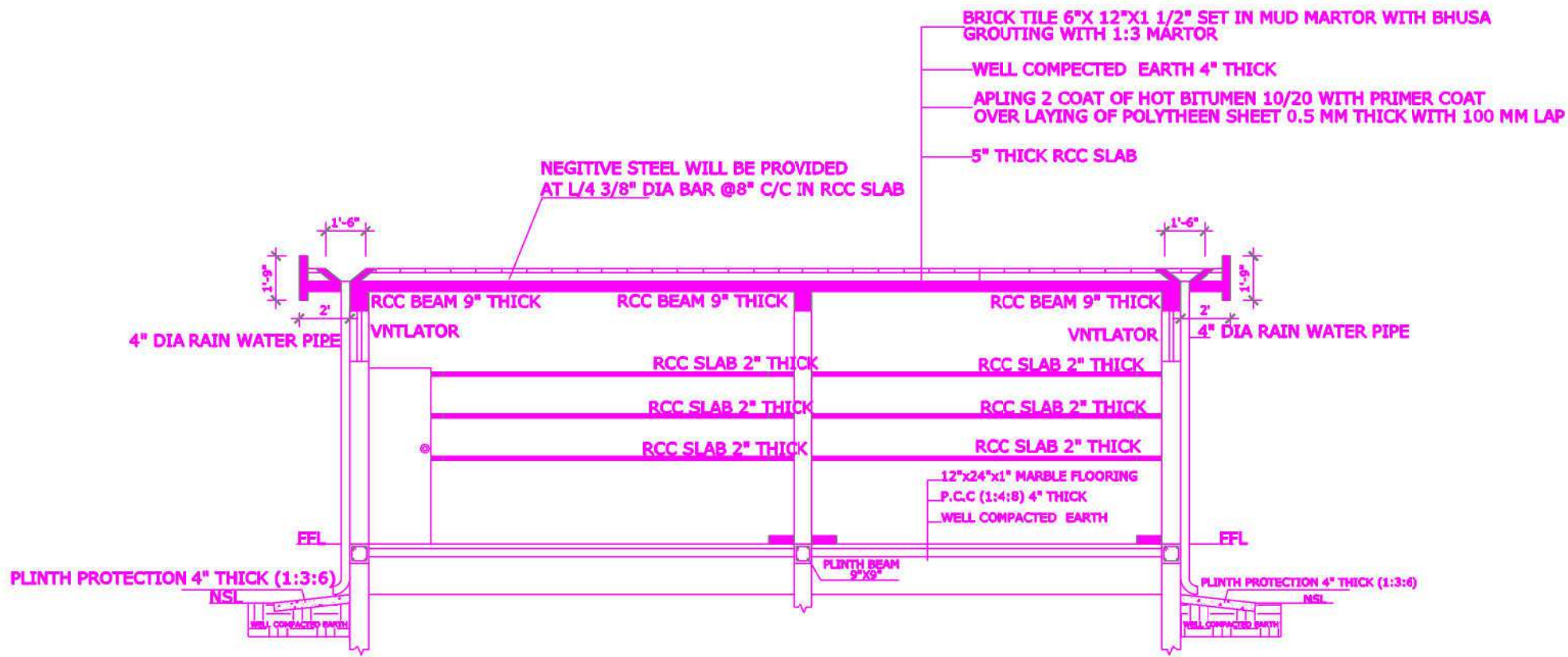

X-SECTION AT A-A

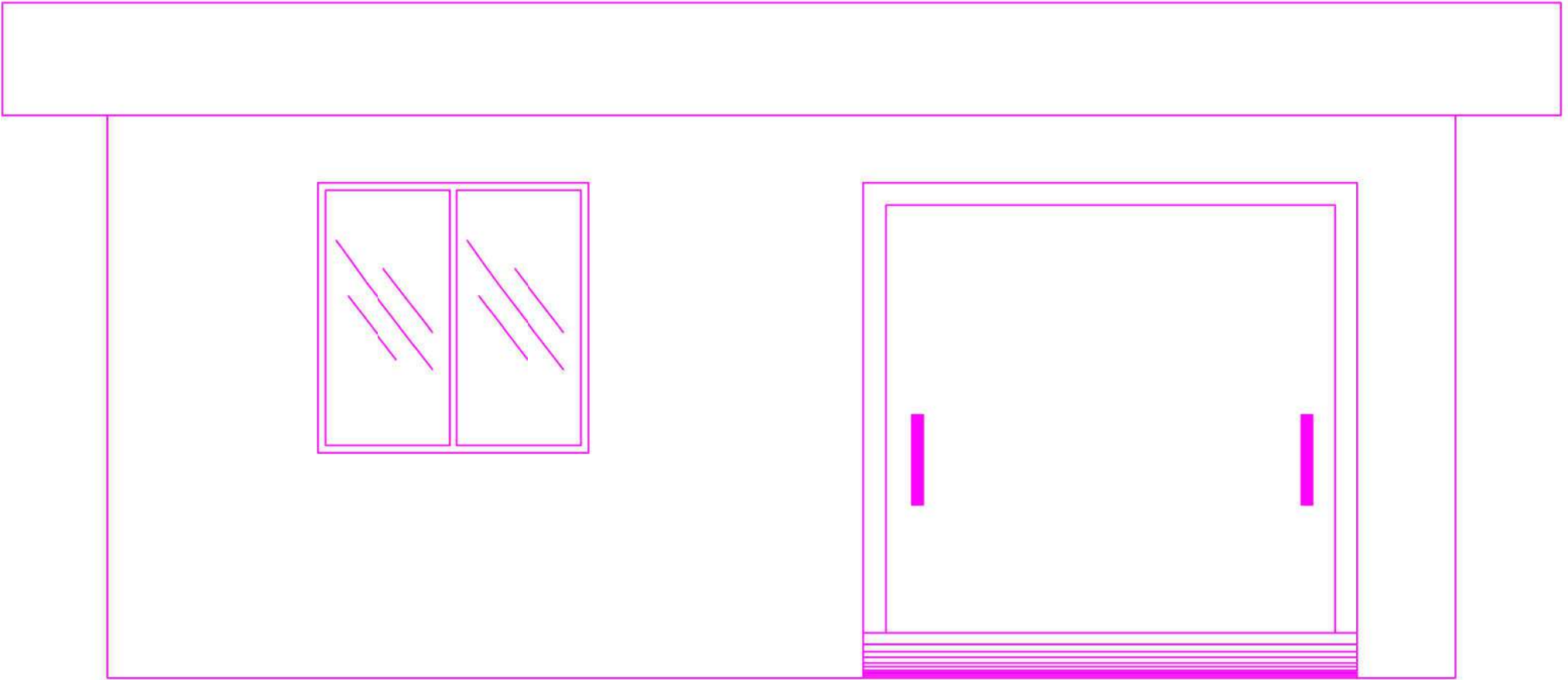

FRONT ELEVATION

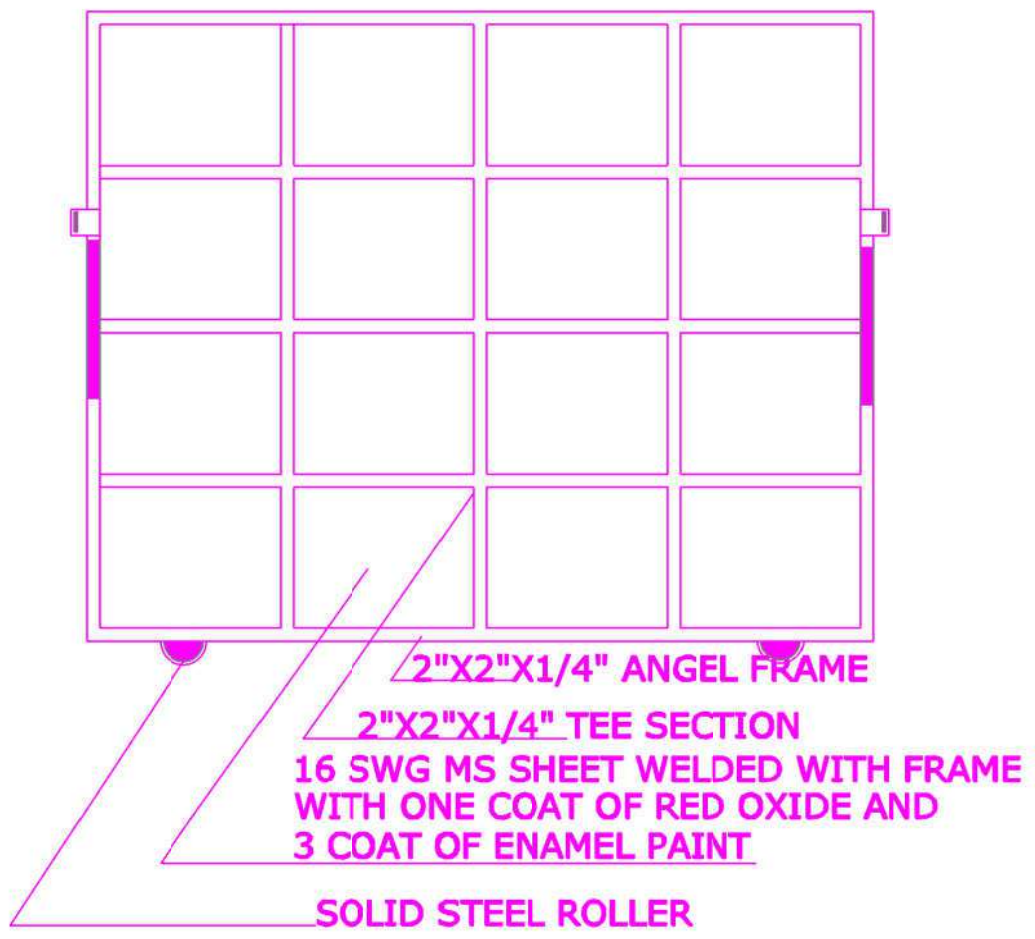

SLIDING STEEL GATE DETAIL

11'-0"X8'-6"

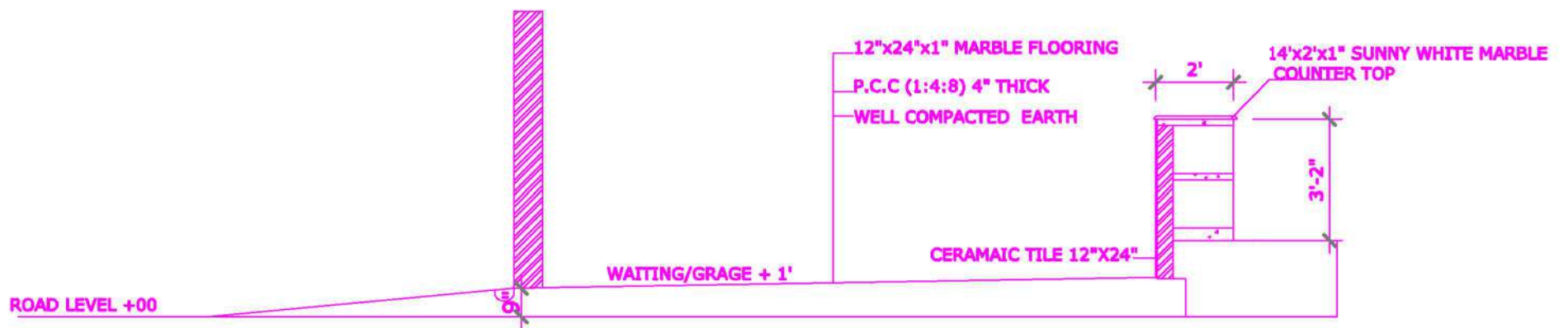

RAMP AND SERVICE COUNTER DETAIL

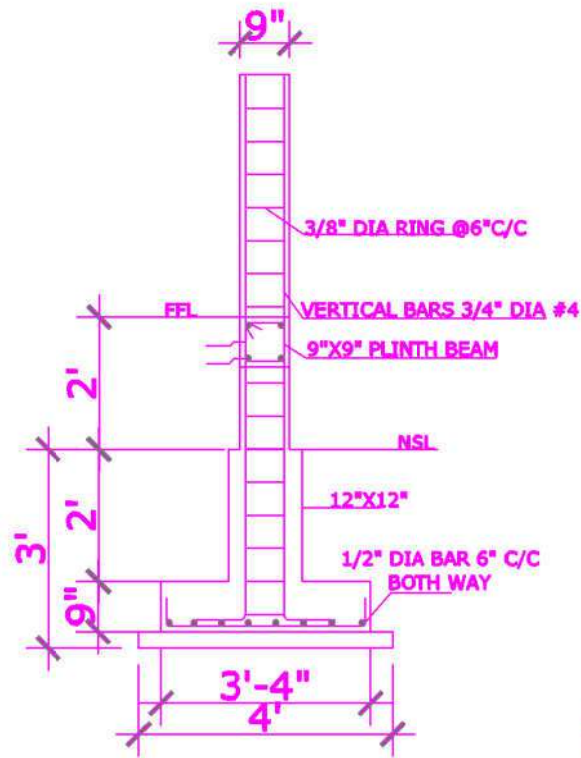

X-SEC OF 9"X9" COL

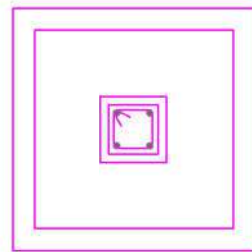

X-SEC OF COL 9"X9"

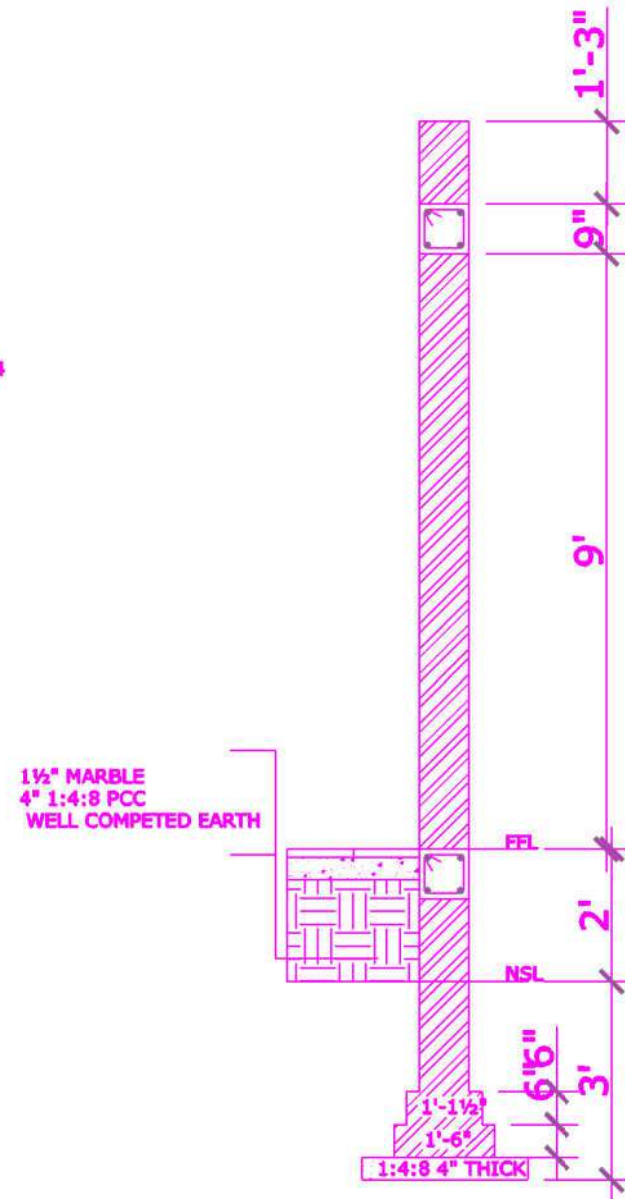

X-SEC OF 9" WALL

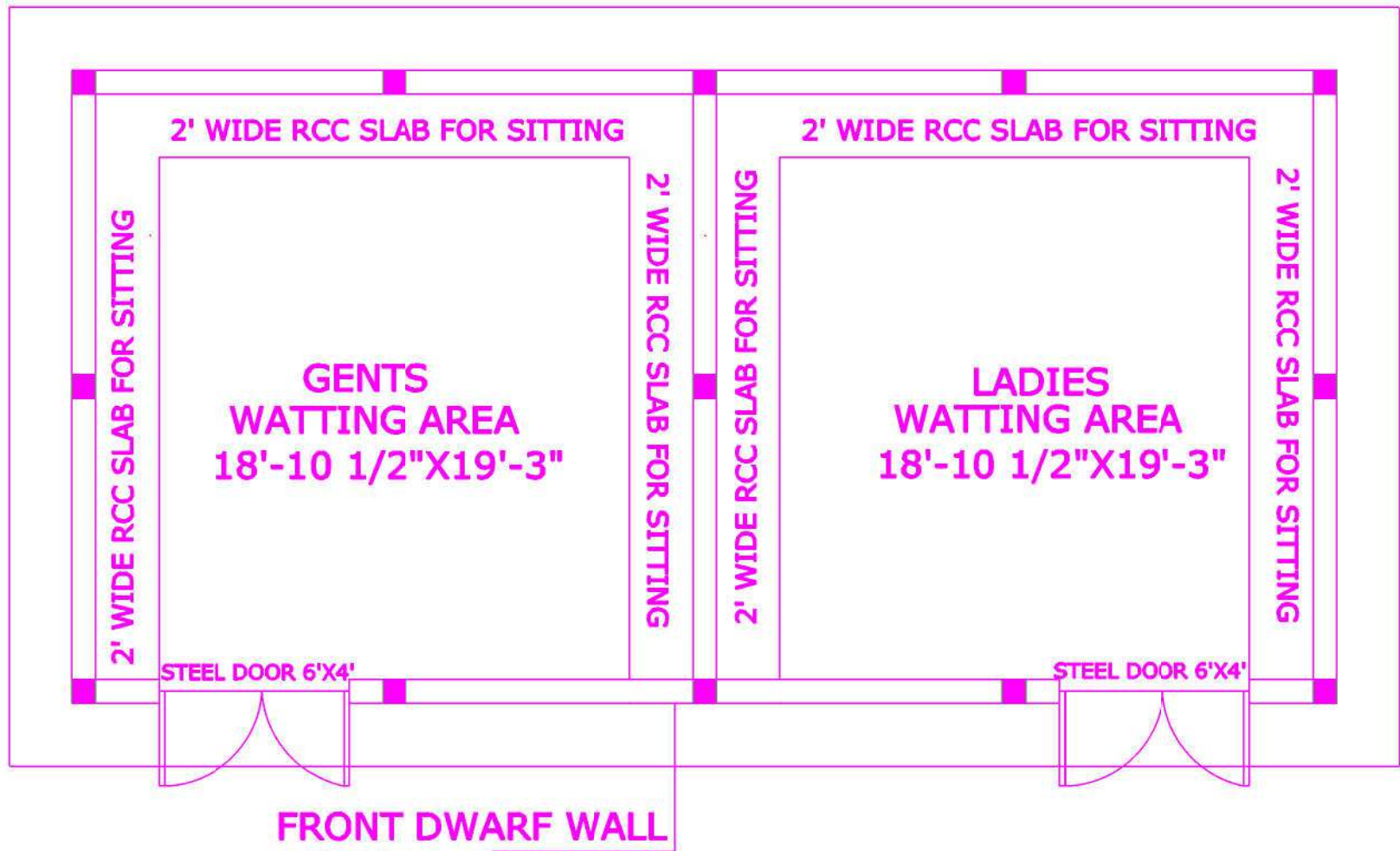

SAMI COVERED WAITING SHED

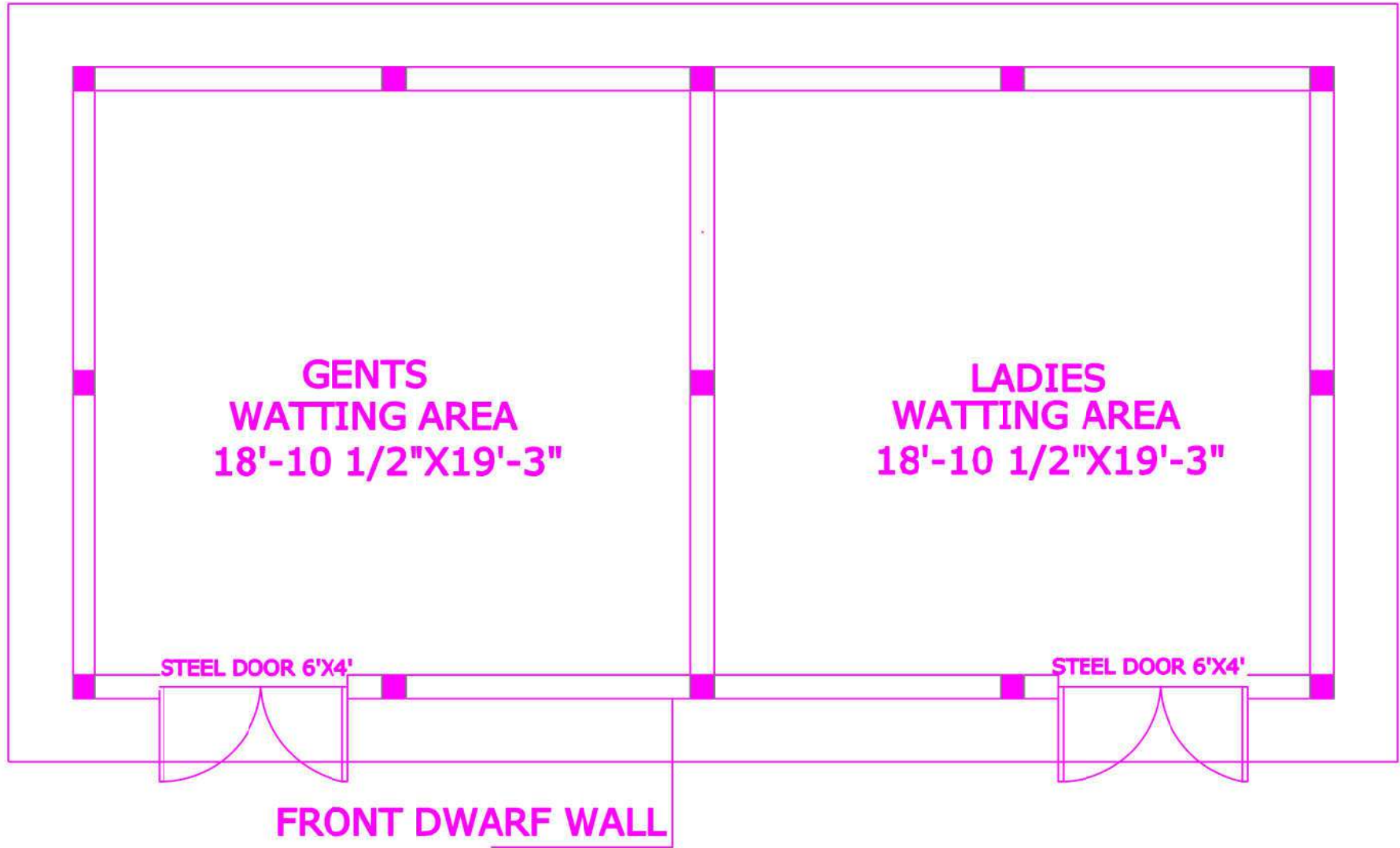

SAMI COVERED WAITING SHED

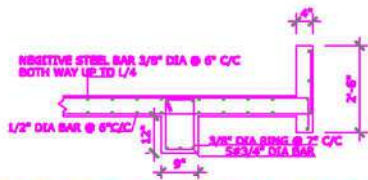

X-SEC OF ROOF BEAM AND SLAB

NEGATIVE STEEL WILL BE PROVIDED AT 1/4 3/8" DIA BAR @ 6" C/C IN RCC SLAB

BRICK TILE 6"X 12"X1 1/2" SET IN MUD MORTAR WITH BHUSA GROUTING WITH 1:3 MORTAR

WELL COMPECTED EARTH 4" THICK

APLING 2 COAT OF HOT BITUMEN 10/20 WITH PRIMER COAT OVER LAYING OF POLYTHEEN SHEET 0.5 MM THICK WITH 100 MM LAP

5" THICK RCC SLAB

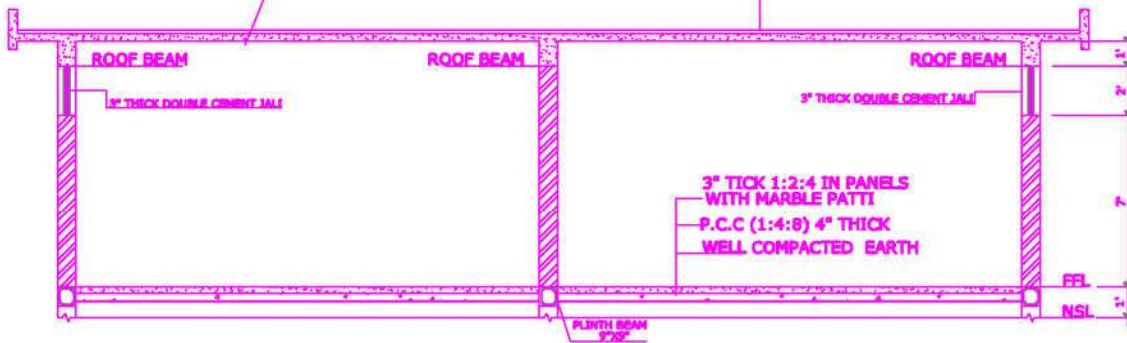

X-SEC AT A-A

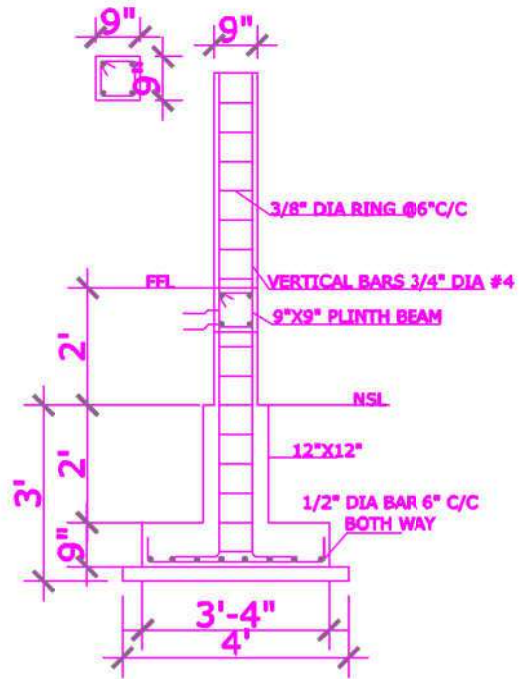

X-SEC OF 9"X9" COL

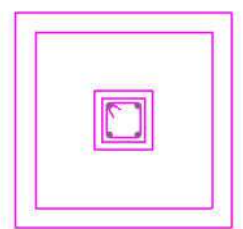

X-SEC OF COL 9"X9"

3" TICK 1:2:4 IN PANELS WITH MARBLE PATTI
 P.C.C (1:4:8) 4" THICK
 WELL COMPACTED EARTH

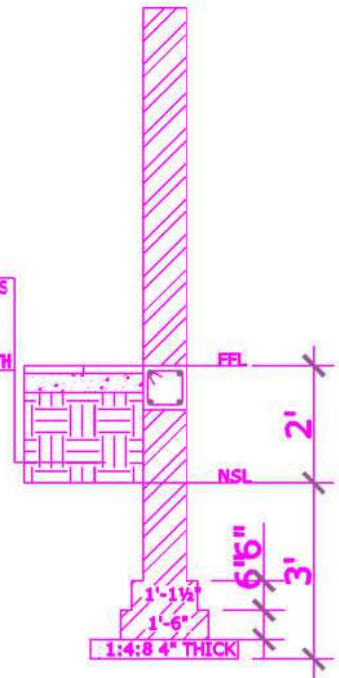

X-SEC OF 9" WALL

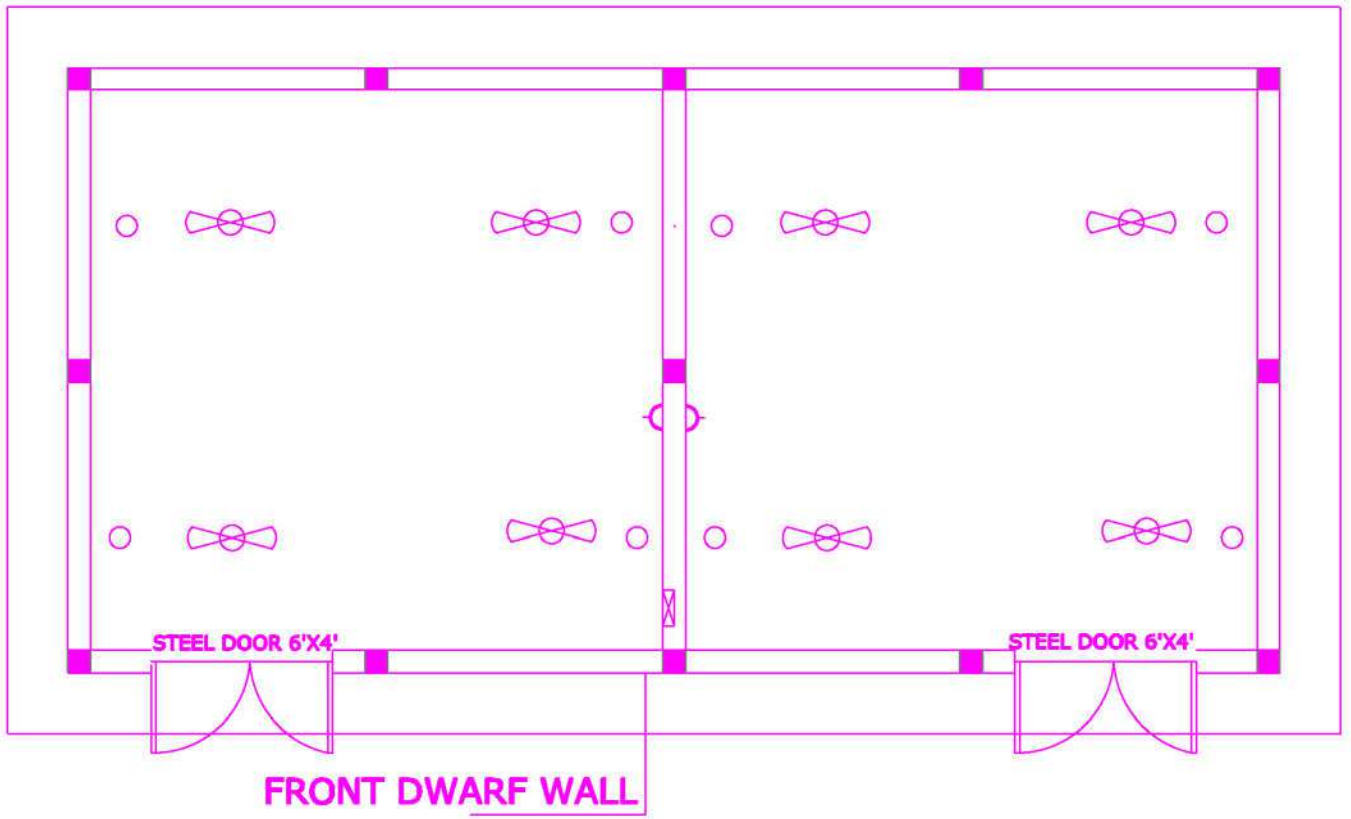

ELECTRICAL PLAN

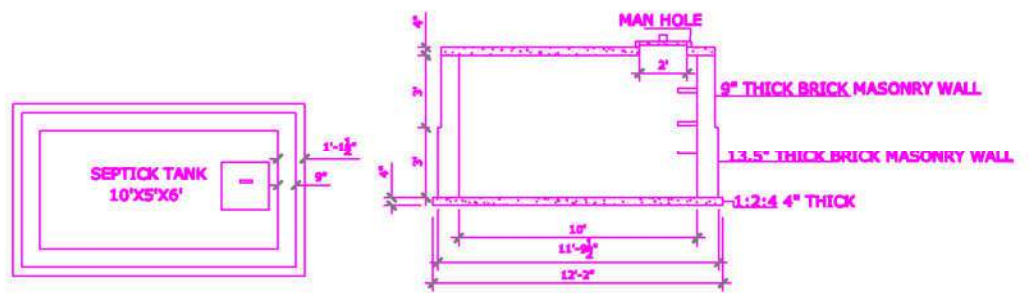

SEPTIC TANK