



OIL & GAS DEVELOPMENT COMPANY LTD

TENDER DOCUMENTS

FOR

**LAYING OF PIPELINES FROM
PANDHI#1 TO BALOCH#1 TO SINJHOROPLANT
(APPROX 37 KM's)**

Tender Enquiry# PROC/LB/LT/C&ESS-18223/2020



SUMMARY OF VOLUMES OF TENDER DOCUMENTS

VOLUME – I

- INTRODUCTION
- INVITATION OF BIDS
- INSTRUCTION TO BIDDERS
- BIDDING DATA
- FORM OF BID AND APPENDICES TO BID
- BILL OF QUANTITIES
- FORMS
- PART – I : GENERAL CONDITIONS OF CONTRACT
- PART – II : PARTICULAR CONDITIONS OF CONTRACT

VOLUME – II (SCOPE OF WORK)

- Scope Of Work
- Specifications

VOLUME – III (DRAWINGS)

- Detail Drawings.



VOLUME – I



CONTENTS

<u>DESCRIPTION</u>	<u>INDEX</u>
INTRODUCTION	1
INVITATION FOR BIDS	2
INSTRUCTION TO BIDDERS	3
BIDDING DATA	4
FORM OF BID AND APPENDICES TO BID INCLUDING BILL OF QUANTITIES	5
FORMS	6
PART – I: GENERAL CONDITIONS OF CONTRACT	7
PART – II: PARTICULAR CONDITIONS OF CONTRACT	8



INTRODUCTION



INTRODUCTION

Oil & Gas Development Company Limited (OGDCL) is an Exploration / Production company which is operating oil/gas fields in various parts of Islamic Republic of Pakistan. At one of the fields, OGDCL intend to develop field by laying approx. 37 KM pipeline at Sinjhor Plant along with installation of well head assembly & piping works.

Contractor shall procure required material, consumables as per Scope of Work & BOQ and deploy machinery, equipment, tools and manpower to execute the above mentioned works and hand over the same to OGDCL after cleaning of lines, pigging & commissioning.

The construction contractor shall prepare their bid as per instructions given in ITB, Bidding Data, and General & Particular Conditions of contract, SOW, BOQ, and Drawing.

OGDCL will provide the followings:

- A-** Line Pipe of all sizes and fittings as per BOQ.
- B-** Radiography and 3rd party Inspection.
- C-** All NOCs (Railway, road, canals, pipe lines, communication etc.) regarding crossings ROW preparation, excavation/ backfilling, piping supports, anchor blocks and other civil works shall be done by OGDCL.

Details are given in Scope of Work & Specifications (VOL – II) & BOQ.

**TABLE OF CONTENTS****VOLUME – I**

Sr. No.	Description	SHEET#
INVITATION FOR BIDS		
	Form	2 of 2
INSTRUCTIONS TO BIDDERS		
A.	General	
IB.1	Scope of Bid	2 of 14
IB.2	Source of Funds	2 of 14
IB.3	Eligible Bidders	2 of 14
IB.4	One Bid Per Bidder	2 of 14
IB.5	Cost of Bidding	2 of 14
IB.6	Site Visit	2 of 14
B.	Bidding Documents	
IB.7	Contents of Bidding Documents	3 of 14
IB.8	Clarification of Bidding Documents	3 of 14
IB.9	Amendment of Bidding Documents	3 of 14
C.	Preparation of Bids	
IB.10.	Language of Bid	4 of 14
IB.11	Documents Accompanying the Bid	4 of 14
IB.12	Bid Prices	5 of 14
IB.13	Currencies of Bid and Payment	6 of 14
IB.14	Bid Validity	6 of 14
IB.15	Bid Security	6 of 14
IB.16	Alternate Proposals by Bidder	7 of 14
IB.17	Pre-Bid Meeting	7 of 14
IB.18	Format and Signing of Bid	8 of 14
D.	Submission of Bids	
IB.19	Sealing and Marking of Bids	8 of 14
IB.20	Deadline for Submission of Bids	9 of 14
IB.21	Late Bids	10 of 14
IB.22	Modification, Substitution and Withdrawal of Bids	10 of 14
E.	Bid Opening and Evaluation	
IB.23	Bid Opening	10 of 14
IB.24	Process to be Confidential	11 of 14



Sr. No.	Description	SHEET#
IB.25	Clarification of Bids	11 of 14
IB.26	Examination of Bids and Determination of Responsiveness	11 of 14
IB.27	Correction of Errors	11 of 14
IB.28	Evaluation and Comparison of Bids	12 of 14
F. Award of Contract		
IB.29	Award	13 of 14
IB.30	Employer's Right to Accept any Bid and to Reject any or all Bids	13 of 14
IB.31	Notification of Award	13 of 14
IB.32	Performance Security	14 of 14
IB.33	Signing of Contract Agreement	14 of 14
IB.34	General Performance of the Bidders	14 of 14
IB.35	Integrity Pact	
BIDDING DATA		2 of 13
BID AND APPENDICES		
FORM OF BID		2 of 15
Appendix-A to Bid	: Special Stipulations	4 of 15
Appendix-B to Bid	: Foreign Currency Requirements	4 of 15
Appendix-C to Bid	: Price Adjustment (Under Clause 70)	4 of 15
Appendix-D to Bid	: Bill of Quantities	5 of 15
Appendix-E to Bid	: Proposed Construction Schedule	6 of 15
Appendix-F to Bid	: Method of Performing the Work	7 of 15
Appendix-G to Bid	: List of Major Equipment – Related Items	8 of 15
Appendix-H to Bid	: Construction Camp and Housing Facilities	9 of 15
Appendix-I to Bid	: List of Subcontractors	10 of 15
Appendix-J to Bid	: Estimated Progress Payments	11 of 15
Appendix-K to Bid	: Organization Chart of the Supervisory Staff and Labour	12 of 15
Appendix-L to Bid	: List of Bidder Drawings	13 of 15
Appendix-M to Bid	: Integrity Pact	14 of 15
AFFIDAVIT		15 of 15
BOQ		
FORMS		
INDEMNITY BOND		2 of 11
BID BOND		4 of 11
PERFORMANCE SECURITY		5 of 11
CONTRACT AGREEMENT		7 of 11
MOBILIZATION ADVANCE GUARANTEE FORM		10 of 11



Sr. No.	Description	SHEET#
PART-I: GENERAL CONDITIONS OF CONTRACT		
Definitions and Interpretation		
1.1	Definitions	2 of 60
1.2	Headings and Marginal Notes	4 of 60
1.3	Interpretation	4 of 60
1.4	Singular and Plural	5 of 60
1.5	Notices, Consents, Approvals, Certificates and Determinations	5 of 60
Engineer and Engineer's Representative		
2.1	Engineer's Duties and Authority	5 of 60
2.2	Engineer's Representative	5 of 60
2.3	Engineer's Authority to Delegate	5 of 60
2.4	Appointment of Assistants	6 of 60
2.5	Instructions in Writing	6 of 60
2.6	Engineer to Act Impartially	6 of 60
Assignment and Subcontracting		
3.1	Assignment of Contract	7 of 60
4.1	Subcontracting	7 of 60
4.2	Assignment of Subcontractors' Obligations	7 of 60
Contract Documents		
5.1	Language/s and Law	8 of 60
5.2	Priority of Contract Documents	8 of 60
6.1	Custody and Supply of Drawings and Documents	8 of 60
6.2	One Copy of Drawings to be Kept on Site	9 of 60
6.3	Disruption of Progress	9 of 60
6.4	Delays and Cost of Delay of Drawings	9 of 60
6.5	Failure by Contractor to Submit Drawings	9 of 60
7.1	Supplementary Drawings and Instructions	9 of 60
7.2	Permanent Works Designed by Contractor	10 of 60
7.3	Responsibility Unaffected by Approval	10 of 60
General Obligations		
8.1	Contractor's General Responsibilities	10 of 60
8.2	Site Operations and Methods of Construction	10 of 60
9.1	Contract Agreement	11 of 60
10.1	Performance Security	11 of 60
10.2	Period of Validity of Performance Security	11 of 60
10.3	Claims under Performance Security	11 of 60



Sr. No.	Description	SHEET#
11.1	Inspection of Site	11 of 60
12.1	Sufficiency of Tender	12 of 60
12.2	Not Foreseeable Physical Obstructions or Conditions	12 of 60
13.1	Work to be in Accordance with Contract	12 of 60
14.1	Programme to be Submitted	13 of 60
14.2	Revised Programme	13 of 60
14.3	Cash Flow Estimate to be Submitted	13 of 60
14.4	Contractor not Relieved of Duties or Responsibilities	13 of 60
15.1	Contractor's Superintendence	13 of 60
16.1	Contractor's Employees	14 of 60
16.2	Engineer at Liberty to Object	14 of 60
17.1	Setting-out	14 of 60
18.1	Boreholes and Exploratory Excavation	15 of 60
19.1	Safety, Security and Protection of the Environment	15 of 60
19.2	Employer's Responsibilities	15 of 60
20.1	Care of Works	15 of 60
20.2	Responsibility to Rectify Loss or Damage	16 of 60
20.3	Loss or Damage Due to Employer's Risks	16 of 60
20.4	Employer's Risks	16 of 60
21.1	Insurance of Works and Contractor's Equipment	17 of 60
21.2	Scope of Cover	17 of 60
21.3	Responsibility for Amounts not Recovered	18 of 60
21.4	Exclusions	18 of 60
22.1	Damage to Persons and Property	18 of 60
22.2	Exceptions	18 of 60
22.3	Indemnity by Employer	19 of 60
23.1	Third Party Insurance (including Employer's Property)	19 of 60
23.2	Minimum Amount of Insurance	19 of 60
23.3	Cross Liabilities	19 of 60
24.1	Accident or Injury to Workmen	19 of 60
24.2	Insurance Against Accident to Workmen	20 of 60
25.1	Evidence and Terms of Insurances	20 of 60
25.2	Adequacy of Insurances	20 of 60
25.3	Remedy on Contractor's Failure to Insure	20 of 60
25.4	Compliance with Policy Conditions	20 of 60
26.1	Compliance with Statutes, Regulations	21 of 60
27.1	Fossils	21 of 60
28.1	Patent Rights	21 of 60
28.2	Royalties	21 of 60
29.1	Interference With Traffic and Adjoining Properties	22 of 60
30.1	Avoidance of Damage to Roads	22 of 60
30.2	Transport of Contractor's Equipment or Temporary Works	22 of 60
30.3	Transport of Materials or Plant	22 of 60
30.4	Waterborne Traffic	23 of 60
31.1	Opportunities for Other Contractors	23 of 60
31.2	Facilities for Other Contractors	23 of 60
32.1	Contractor to Keep Site Clear	24 of 60
33.1	Clearance of Site on Completion	24 of 60



Sr. No.	Description	SHEET#
Labour		
34.1	Engagement of Staff and Labour	24 of 60
35.1	Returns of Labour and Contractor's Equipment	24 of 60
Materials, Plant and Workmanship		
36.1	Quality of Materials, Plant and Workmanship	24 of 60
36.2	Cost of Samples	25 of 60
36.3	Cost of Tests	25 of 60
36.4	Cost of Tests not Provided for	25 of 60
36.5	Engineer's Determination where Tests not Provided for	25 of 60
37.1	Inspection of Operations	26 of 60
37.2	Inspection and Testing	26 of 60
37.3	Dates for Inspection and Testing	26 of 60
37.4	Rejection	27 of 60
37.5	Independent Inspection	27 of 60
38.1	Examination of Work before Covering up	27 of 60
38.2	Uncovering and Making Openings	27 of 60
39.1	Removal of Improper Work, Materials or Plant	27 of 60
39.2	Default of Contractor in Compliance	28 of 60
Suspension		
40.1	Suspension of Work	28 of 60
40.2	Engineer's Determination following Suspension	28 of 60
40.3	Suspension lasting more than 84 Days	29 of 60
Commencement and Delays		
41.1	Commencement of Works	29 of 60
42.1	Possession of Site and Access Thereto	29 of 60
42.2	Failure to Give Possession	30 of 60
42.3	Rights of Way and Facilities	30 of 60
43.1	Time for Completion	30 of 60
44.1	Extension of Time for Completion	30 of 60
44.2	Contractor to Provide Notification and Detailed Particulars	31 of 60
44.3	Interim Determination of Extension	31 of 60
45.1	Restriction on Working Hours	31 of 60
46.1	Rate of Progress	31 of 60
47.1	Liquidated Damages for Delay	32 of 60
47.2	Reduction of Liquidated Damages	32 of 60
48.1	Taking-Over Certificate	32 of 60
48.2	Taking-Over of Sections or Parts	33 of 60
48.3	Substantial Completion of Parts	33 of 60
48.4	Surfaces Requiring Reinstatement	33 of 60



Sr. No.	Description	SHEET#
Defects Liability		
49.1	Defects Liability Period	34 of 60
49.2	Completion of Outstanding Work and Remedying Defects	34 of 60
49.3	Cost of Remedying Defects	34 of 60
49.4	Contractor's Failure to Carry Out Instructions	35 of 60
50.1	Contractor to Search	35 of 60
Alterations, Additions and Omissions		
51.1	Variations	35 of 60
51.2	Instructions for Variations	36 of 60
52.1	Valuation of Variations	36 of 60
52.2	Power of Engineer to Fix Rates	36 of 60
52.3	Variations Exceeding 15 percent	37 of 60
52.4	Day work	37 of 60
Procedure for Claims		
53.1	Notice of Claims	38 of 60
53.2	Contemporary Records	38 of 60
53.3	Substantiation of Claims	38 of 60
53.4	Failure to Comply	39 of 60
53.5	Payment of Claims	39 of 60
Contractor's Equipment, Temporary Works and Materials		
54.1	Contractor's Equipment, Temporary Works and Materials; Exclusive Use for the Works.	39 of 60
54.2	Employer not Liable for Damage	39 of 60
54.3	Customs Clearance	39 of 60
54.4	Re-export of Contractor's Equipment	40 of 60
54.5	Conditions of Hire of Contractor's Equipment	40 of 60
54.6	Costs for the Purpose of Clause 63	40 of 60
54.7	Incorporation of Clause in Subcontracts	40 of 60
54.8	Approval of Materials not Implied	40 of 60
Measurement		
55.1	Quantities	41 of 60
56.1	Works to be Measured	41 of 60
57.1	Method of Measurement	41 of 60
57.2	Breakdown of Lump Sum Items	41 of 60
Provisional Sums		
58.1	Definition of "Provisional Sum"	42 of 60
58.2	Use of Provisional Sums	42 of 60
58.3	Production of Vouchers	42 of 60



Sr. No.	Description	SHEET#
Nominated Subcontractors		
59.1	Definition of “Nominated Subcontractors”	42 of 60
59.2	Nominated Subcontractors; Objection to Nomination	42 of 60
59.3	Design Requirements to be Expressly Stated	43 of 60
59.4	Payments to Nominated Subcontractors	43 of 60
59.5	Certification of Payments to Nominated Subcontractors	44 of 60
Certificates and Payment		
60.1	Monthly Statements	44 of 60
60.2	Monthly Payments	45 of 60
60.3	Payment of Retention Money	45 of 60
60.4	Correction of Certificates	46 of 60
60.5	Statement at Completion	46 of 60
60.6	Final Statement	47 of 60
60.7	Discharge	47 of 60
60.8	Final Payment Certificate	48 of 60
60.9	Cessation of Employer’s Liability	48 of 60
60.10	Time for Payment	48 of 60
61.1	Approval only by Defects Liability Certificate	49 of 60
62.1	Defects Liability Certificate	49 of 60
62.2	Unfulfilled Obligations	49 of 60
Remedies		
63.1	Default of Contractor	49 of 60
63.2	Valuation at Date of Termination	50 of 60
63.3	Payment after Termination	51 of 60
63.4	Assignment of Benefit of Agreement	51 of 60
64.1	Urgent Remedial Work	51 of 60
Special Risks		
65.1	No Liability for Special Risks	52 of 60
65.2	Special Risks	52 of 60
65.3	Damage to Works by Special Risks	52 of 60
65.4	Projectile, Missile	53 of 60
65.5	Increased Costs arising from Special Risks	53 of 60
65.6	Outbreak of War	53 of 60
65.7	Removal of Contractor’s Equipment on Termination	53 of 60
65.8	Payment if Contract Terminated	54 of 60
Release from Performance		
66.1	Payment in Event of Release from Performance	55 of 60



Sr. No.	Description	SHEET#
Settlement of Disputes		
67.1	Engineer's Decision	55 of 60
67.2	Amicable Settlement	56 of 60
67.3	Arbitration	56 of 60
67.4	Failure to Comply with Engineer's Decision	57 of 60
Notices		
68.1	Notice to Contractor	57 of 60
68.2	Notice to Employer and Engineer	57 of 60
68.3	Change of Address	57 of 60
Default of Employer		
69.1	Default of Employer	57 of 60
69.2	Removal of Contractor's Equipment	58 of 60
69.3	Payment on Termination	58 of 60
69.4	Contractor's Entitlement to Suspend Work	58 of 60
69.5	Resumption of Work	59 of 60
Changes in Cost and Legislation		
70.1	Increase or Decrease of Cost	59 of 60
70.2	Subsequent Legislation	59 of 60
Currency and Rates of exchange		
71.1	Currency Restrictions	59 of 60
72.1	Rates of Exchange	60 of 60
72.2	Currency Proportions	60 of 60
72.3	Currencies of Payment for Provisional Sums	60 of 60
PART II - PARTICULAR CONDITIONS OF CONTRACT		
1.1	Definitions	2 of 21
2.1	Engineer's Duties and Authority	2 of 21
2.2	Engineer's Representative	4 of 21
2.7	Engineer Not Liable	4 of 21
2.8	Replacement of the Engineer	4 of 21
5.1	Language(s) and Law	5 of 21
5.2	Priority of Contract Documents	5 of 21
6.6	Shop Drawings	5 of 21
6.7	As-Built Drawings	6 of 21
10.1	Performance Security	6 of 21
10.4	Performance Security Binding on Variations and Changes	6 of 21
14.1	Programme to be Submitted	6 of 21
14.3	Cash Flow Estimate to be Submitted	7 of 21



Sr. No.	Description	SHEET#
14.5	Detailed Programme and Monthly Progress Report	7 of 21
15.2	Language Ability of Contractor's Representative	7 of 21
15.3	Contractor's Representative	8 of 21
16.3	Language Ability of Superintending Staff of Contractor	8 of 21
16.4	Employment of Local Personnel	8 of 21
19.3	Safety Precautions	8 of 21
19.4	Lighting Works at Night	9 of 21
20.4	Employer's Risks	9 of 21
21.1	Insurance of Works and Contractor's Equipment	9 of 21
21.3	Responsibility for Amounts not Recovered	9 of 21
21.4	Exclusions	9 of 21
21.5	Taxes	9 of 21
22.2	Exceptions	10 of 21
22.3	Indemnity by the Employer	10 of 21
23.1	Third Party Insurance	10 of 21
25.1	Evidence and Terms of Insurance	11 of 21
25.3	Remedy on Contractor Failure to Insure	11 of 21
25.4	Compliance with Policy Conditions	11 of 21
25.5	Insurance Company	11 of 21
31.3	Co-operation with Other Contractors	11 of 21
34.2	Rates of Wages and Conditions of Labour	12 of 21
34.3	Employment of Persons in the Service of Others	12 of 21
34.4	Housing for Labour	12 of 21
34.5	Health and Safety	12 of 21
34.6	Epidemics	12 of 21
34.7	Supply of Water	13 of 21
34.8	Alcoholic Liquor or Drugs	13 of 21
34.9	Arms and Ammunition	13 of 21
34.10	Festivals and Religious Customs	13 of 21
34.11	Disorderly Conduct	13 of 21
34.12	Compliance by Subcontractors	13 of 21
35.2	Records of Safety and Health	13 of 21
35.3	Reporting of Accidents	14 of 21
36.6	Use of Pakistani Materials and Services	14 of 21
41.1	Commencement of Works	14 of 21
48.2	Taking Over of Sections or Parts	14 of 21
49.5	Extensions of Defects Liability Period	14 of 21
51.2	Instructions for Variations	15 of 21
52.1	Valuation of Variations	15 of 21
53.4	Failure to Comply	15 of 21
54.3	Customs Clearance	15 of 21
54.5	Conditions of Hire of Contractor's Equipment	15 of 21
59.4	Payments to Nominated Sub-contractors	15 of 21
59.5	Evidence of Payments	15 of 21
60.1	Monthly Statements	16 of 21
60.2	Monthly Payments	16 of 21
60.11	Secured Advance on Materials	16 of 21



Sr. No.	Description	SHEET#
60.12	Financial Assistance to Contractor	17 of 21
63.1	Default of Contractor	18 of 21
65.2	Special Risks	18 of 21
67.3	Arbitration	18 of 21
68.1	Notice to Contractor	18 of 21
68.2	Notice to Employer and Engineer	19 of 21
70.1	Increase or Decrease of Cost	19 of 21
73.1	Payment of Income Tax	19 of 21
73.2	Customs Duty & Taxes	19 of 21
74.1	Integrity Pact	19 of 21
75.1	Termination of Contract for Employer's Convenience	20 of 21
76.1	Liability of Contractor	20 of 21
77.1	Joint and Several Liability	20 of 21
78.1	Details to be Confidential	20 of 21

VOLUME – II

Scope of Work
Specifications

VOLUME – III

DRAWINGS



INVITATION FOR BIDS



INVITATION FOR BIDS

Reference No.: _____

Date: _____

1. M/s Elite Engineering Pvt Ltd Lahore
2. A. Karim & Sons Engineering Pvt Ltd Karachi
3. M/s Petrocon Pvt Ltd Karachi
4. M/s Zealcon Engineering Pvt Ltd Lahore
5. M/s Izhar Steel Pvt Ltd Lahore
6. M/s Qurban & Sons Guddu Barrage
7. M/s Descon Engineering Pvt Ltd Lahore
8. M/s SKM Engineering & Construction Company Mardan
9. M/s Latif Petroleum & Engineering Services Pvt Ltd Islamabad
10. M/s Reliance Engineering & Construction Services Islamabad
11. M/s Techno Engineering Islamabad
12. M/s Muhammad Yousaf Govt Contractor Multan
13. M/s Al Qasim Construction Pvt Ltd Islamabad
14. M/S Allied contractors Islamabad
15. M/s Sarfraz Hussain & Co Attock

HIRING OF SERVICES LAYING OF PIPELINES FROM PANDHI#1 TO BALOCH#1 TO SINJHORO PLANT (APPROX 37 KM's)

1. The Oil & Gas Development Company Limited (OGDCL) Islamabad the (“Employer”) intends to develop Sinjhoro field under the contract. Bidding is open for all eligible bidders with valid Pakistan Engineering Council (PEC) License in category C-4 and above which is mandatory and to be submitted along with bidding documents.
2. The Employer invites sealed bids under **Single Stage – One Envelope** bidding procedure, from pre-qualified contractors.



3. Bidders may obtain further information from, inspect at and acquire the Bidding Documents.

4. **PRE-BID MEETING:**

A pre-bid meeting will be arrange **before 10days** of opening for the purpose of clarifying issues and answering questions on any matter that may be raised at that stage. Bidders or their official representatives are advised to attend the conference which will be held in the office of:

MANAGER (PIPELINE & FABRICATION)
Room#21, 1st Floor, Engineering Department, Masood Mansion
F-8 Markaz, Islamabad.
Phone# 051-9261293

5. All bids must be accompanied by a Bid Security in the form of a Bank Draft/ Pay Order/ Deposit at Call / CDR / Bank Guarantee payable at any scheduled Bank in Islamabad for an amount of **PKR 2.5 Million** to be submitted original with financial Bid & must be delivered in the office of “The General Manager (SCM) on behalf of **“Oil & Gas Development Company Limited (OGDCL), Islamabad”**.
6. Bids will be opened as per announced date, time and venue in the presence of bidder’ representatives.
7. The bids on prescribed format (Copy attached) should be stamped and duly signed by authorized representative. The bid with incomplete, inaccurate, or irrelevant information shall not be considered.
8. The bids must be delivered at the reception of OGDCL house Jinnah Avenue Blue Area Islamabad on or before the following bid opening time.



9. The rates shall be submitted in a sealed envelope addressed as under on the attached prescribed format and must reach this office by _____ by _____ hrs.(Sharp) The envelope should be marked as follows;

TENDER ENQUIRY NO. _____

DO NOT OPEN BEFORE _____

**Manager (Local) Procurement,
SCM Department, OGDCL-House,
Jinnah Avenue, Islamabad**

10. The bid shall be opened on the same day i.e. _____. Your authorized representative may attend the referred bid opening, if desired, and communicate the name therein.
11. Any bid received after the deadline of bid submission mentioned above will be rejected and the same will be returned unopened.
12. OGDCL reserves the right to annul the bidding process prior to award of scope of work without justifying any reason.

**CHIEF ENGINEER
(PIPELINE & FAB.)**



INSTRUCTIONS TO BIDDERS



INSTRUCTIONS TO BIDDERS

A. GENERAL

IB.1 Scope of Bid

- 1.1 The Employer as defined in the Bidding Data hereinafter called “the Employer” wishes to receive bids for the construction and completion of works as described in these Bidding Documents, and summarized in the Bidding Data hereinafter referred to as the “Works”.
- 1.2 The successful bidder will be expected to complete the Works within the time specified in Appendix-A to Bid.

IB.2 Source of Funds

- 2.1 The Employer has applied for/received a loan/credit from the source (s) indicated in the Bidding Data in various currencies towards the cost of the project specified in the Bidding Data and it is intended that part of the proceeds of this loan/credit will be applied to eligible payments under the Contract for which these Bidding Documents are issued.

IB.3 Eligible Bidders

- 3.1 This Invitation for Bids is open to the followings:
 - a. Duly licensed by the Pakistan Engineering Council (PEC) in the category & field of specialization relevant to the value of the Works.
 - b. Duly pre-qualified / enlisted with the Employer.

IB.4 One Bid per Bidder

- 4.1 Each bidder shall submit only one bid either by himself, or as a partner in a joint venture. A bidder who submits or participates in more than one bid (other than alternatives pursuant to Clause IB.16) will be disqualified.

IB.5 Cost of Bidding

- 5.1 The bidders shall bear all costs associated with the preparation and submission of their respective bids and the Employer will in no case be responsible or liable for those costs, regardless of the conduct or outcome of the bidding process.

IB.6 Site Visit

- 6.1 The bidders are advised to visit and examine the Site of Works and its surroundings and obtain for themselves on their own responsibility all information that may be necessary for preparing the bid and entering into a contract for construction of the Works. All cost in this respect shall be at the bidder’s own expense.
- 6.2 The bidders and any of their personnel or agents will be granted permission by the Employer to enter upon his premises and lands for the purpose of such inspection, but



only upon the express condition that the bidders, their personnel and agents, will release and indemnify the Employer, his personnel and agents from and against all liability in respect thereof and will be responsible for death or personal injury, loss of or damage to property and any other loss, damage, costs and expenses incurred as a result of such inspection.

B. BIDDING DOCUMENTS

IB.7 Contents of Bidding Documents

7.1 The Bidding Documents, in addition to invitation for bids, are those stated below and should be read in conjunction with any Addenda issued in accordance with Clause IB.9.

1. Instructions to Bidders.
2. Bidding Data.
3. General Conditions of Contract, Part-I (GCC).
4. Particular Conditions of Contract, Part-II (PCC).
5. Specifications - Technical Provisions.
6. Form of Bid & Appendices to Bid.
7. Bill of Quantities (Appendix-D to Bid).
8. Form of Bid Security.
9. Form of Contract Agreement.
10. Forms of Performance Security and Mobilization Advance Guarantee/Bond.
11. Drawings.

7.2 The bidders are expected to examine carefully the contents of all the above documents. Failure to comply with the requirements of bid submission will be at the Bidder's own risk. Pursuant to Clause IB.26, bids which are not substantially responsive to the requirements of the Bidding Documents will be rejected.

IB.8 Clarification of Bidding Documents

8.1 Any prospective bidder requiring any clarification (s) in respect of the Bidding Documents may notify the Employer in writing at the Employer's address indicated in the Invitation for Bids. The Employer will respond to any request for clarification which he receives earlier than 28 days prior to the deadline for submission of bids.

Copies of the Employer's response will be forwarded to all purchasers of the Bidding Documents, including a description of the enquiry but without identifying its source.

IB.9 Amendment of Bidding Documents

9.1 At any time prior to the deadline for submission of bids, the Employer may, for any reason, whether at his own initiative or in response to a clarification requested by a prospective bidder, modify the Bidding Documents by issuing addendum.

9.2 Any addendum thus issued shall be part of the Bidding Documents pursuant to Sub-Clause 7.1 hereof and shall be communicated in writing to all purchasers of the Bidding Documents. Prospective bidders shall acknowledge receipt of each addendum



in writing to the Employer.

- 9.3 To afford prospective bidders reasonable time in which to take an addendum into account in preparing their bids, the Employer may extend the deadline for submission of bids in accordance with Clause IB.20
- 9.4 “Any other clarification given by the employer in writing to the bidders at pre-bid stage shall be considered as an addendum and shall be part of the bid documents.”

C. PREPARATION OF BIDS

IB.10 Language of Bid

10.1 The bid and all correspondence and documents related to the bid exchanged by a bidder and the Employer shall be in the bid language stipulated in the Bidding Data and Particular Conditions of Contract. Supporting documents and printed literature furnished by the bidders may be in any other language provided the same are accompanied by an accurate translation of the relevant parts in the bid language, in which case, for purposes of evaluation of the bid, the translation in bid language shall prevail.

IB.11 Documents Accompanying the Bid

11.1 Each bidder shall:

- (a) Submit a written power of attorney authorizing the signatory of the bid to act for and on behalf of the bidder;
- (b) Update the information indicated and listed in the Bidding Data and previously submitted with the application for prequalification, and continue to meet the minimum criteria set out in the prequalification documents which as a minimum, would include the following :
- (i) Evidence of access to financial resources along with average annual construction turnover;
- (ii) Financial predictions for the current year and the two following years including the effect of known commitments;
- (iii) Work commitments since prequalification;
- (iv) Current litigation information.
- (v) Availability of critical equipment.
- (c) Furnish a proposal taking into account the various Appendices to Bid specially the following:

Appendix-E to Bid	Proposed Construction Schedule
Appendix-F to Bid	Method of Performing the Work
Appendix-G to Bid	List of Major Equipment
Appendix-K to Bid	Organization Chart for Supervisory Staff

and other pertinent information such as mobilization programme etc;



- 11.2 Bids submitted by a joint venture of two (2) or more firms shall comply with the following requirements:
- (a) The bid and in case of a successful bid, the Form of Contract Agreement shall be signed so as to be legally binding on all partners;
 - (b) One of the joint venture partners shall be nominated as being in charge; and this Authorization shall be evidenced by submitting a power of attorney signed by legally authorized signatories of all the joint venture partners;
 - (c) The partner-in-charge shall always be duly authorized to deal with the Employer regarding all matters related with and/or incidental to the execution of Works as per the terms and Conditions of Contract and in this regard to incur any and all liabilities, receive instructions, give binding undertakings and receive payments on behalf of the joint venture;
 - (d) All partners of the joint venture shall at all times and under all circumstances be liable jointly and severally for the execution of the Contract in accordance with the Contract terms and a statement to this effect shall be included in the authorization mentioned under Sub-Para(b) above as well as in the Form of Bid and in the Form of Contract Agreement (in case of a successful bid); and
 - (e) A copy of the agreement entered into by the joint venture partners shall be submitted with the bid stating the conditions under which it will function, its period of duration, the persons authorized to represent and obligate it and which persons will be directly responsible for due performance of the Contract and can give valid receipts on behalf of the joint venture, the proportionate participation of the several firms forming the joint venture, and any other information necessary to permit a full appraisal of its functioning. No amendments / modifications whatsoever in the joint venture agreement shall be agreed to between the joint venture partners without prior written consent of the Employer.
- 11.3 Bidders shall also submit proposals of work methods and schedule, in sufficient detail to demonstrate the adequacy of the Bidders' proposals to meet the technical specifications and the completion time referred to in Sub-Clause 1.2 hereof.

IB.12 Bid Prices

- 12.1 Unless stated otherwise in the Bidding Documents, the Contract shall be for the whole of the Works as described in Sub-Clause 1.1 hereof, based on the unit rates and / or prices submitted by the bidder.
- 12.2 The bidders shall fill in rates and prices for all items of the Works described in the Bill of Quantities. Items against which no rate or price is entered by a bidder will not be paid for by the Employer when executed and shall be deemed covered by rates and prices for other items in the Bill of Quantities.
- 12.3 All duties, taxes and other levies payable by the Contractor under the Contract, or for any other cause, as on the date 28 days prior to the deadline for submission of bids shall be included in the rates and prices and the total Bid Price submitted by a bidder.

Additional / reduced duties, taxes and levies due to subsequent additions or changes in



legislation shall be reimbursed / deducted as per Sub-Clause 70.2 of the General Conditions of Contract Part-I.

- 12.4 The rates and prices quoted by the bidders are subject to adjustment during the performance of the Contract in accordance with the provisions of Clause 70 of the Conditions of Contract. The bidders shall furnish the prescribed information for the price adjustment formulae in Appendix-C to Bid, and shall submit with their bids such other supporting information as required under the said Clause.

IB.13 Currencies of Bid and Payment

- 13.1 The unit rates and the prices shall be quoted by the bidder entirely in Pak rupees. A bidder expecting to incur expenditures in other currencies for inputs to the Works supplied from outside the Employer's country (referred to as the "Foreign Currency Requirements") shall indicate the same in Appendix-B to Bid. The proportion of the Bid Price (excluding Provisional Sums) needed by him for the payment of such Foreign Currency Requirements either (i) entirely in the currency of the Bidder's home country or, (ii) at the bidder's option, entirely in Pak rupees provided always that a bidder expecting to incur expenditures in a currency or currencies other than those stated in (i) and (ii) above for a portion of the foreign currency requirements, and wishing to be paid accordingly, shall indicate the respective portions in his bid.
- 13.2 The rates of exchange to be used by the bidder for currency conversion shall be the TT&OD Selling Rates published or authorized by the State Bank of Pakistan prevailing on the date 28 days prior to the deadline for submission of bids.

For the purpose of payments, the exchange rates used in bid preparation shall apply for the duration of the Contract.

IB.14 Bid Validity

- 14.1 Bids shall remain valid for the period stipulated in the Bidding Data after the Date of Bid Opening specified in Clause IB.23.
- 14.2 In exceptional circumstances, prior to expiry of the original bid validity period, the Employer may request that the bidders extend the period of validity for a specified additional period which shall in no case be more than the original bid validity period. The request and the responses thereto shall be made in writing. A bidder may refuse the request without forfeiting his Bid Security. A bidder agreeing to the request will not be required or permitted to modify his bid, but will be required to extend the validity of his Bid Security for the period of the extension, and in compliance with Clause IB.15 in all respects.

IB.15 Bid Security

- 15.1 Each bidder shall furnish, as part of his bid, a Bid Security in the amount stipulated in the Bidding Data in Pak Rupees.
- 15.2 The Bid Security shall be, at the option of the bidder, in the form of Pay Order or



Demand Draft or Deposit at Call or CDR or Bank Guarantee issued by a scheduled Bank in favour of Oil & Gas Development Company Limited, Islamabad payable at Islamabad valid for a period 28 days beyond the Bid Validity date.

- 15.3 Any bid not accompanied by an acceptable Bid Security shall be rejected by the Employer as non-responsive.
- 15.4 The bid securities of unsuccessful bidders will be returned as promptly as possible, but not later than 28 days after the expiration of the period of Bid Validity.
- 15.5 The Bid Security of the successful bidder will be returned when the bidder has furnished the required Performance Security and signed the Contract Agreement.
- 15.6 The Bid Security may be forfeited:
- (a) If the bidder withdraws his bid except as provided in Sub-Clause 22.1;
 - (b) If the bidder submits forged or fake bidding documents
 - (c) Fails to execute the Contract in accordance with the tender document; or
 - (d) If the bidder does not accept the correction of his Bid Price pursuant to Sub-Clause 27.2 hereof; or
 - (e) In case of any loss or damage suffered by the Purchaser due to any of the aforementioned act of the bidder(s) is more than the Liquidated Damages, the Purchaser will be entitled to recover the losses through encashment of Bid Securities/ Bank Guarantee(s)/Earnest Money or forfeiture of Security furnished by the bidder in other procurement cases
 - (f) In the case of successful bidder, if he fails within the specified time limit to:
 - (i) Furnish the required Performance Security; Advance Bank Guarantee; or
 - (ii) Sign the Contract Agreement.
 - (g) Any other reason warranting the confiscation of the guarantee.

IB.16 Alternate Proposals by Bidder

- 16.1 Should any bidder consider that he can offer any advantages to the Employer by a modification to the designs, specifications or other conditions, he may, in addition to his bid to be submitted in strict compliance with the Bidding Documents, submit any Alternate Proposal(s) containing (a) relevant design calculations; (b) technical specifications; (c) proposed construction methodology; and (d) any other relevant details / conditions, provided always that the total sum entered on the Form of Bid shall be that which represents complete compliance with the Bidding Documents.
- 16.2 Alternate Proposal(s), if any, of the lowest evaluated responsive bidder only may be considered by the Employer as the basis for the award of Contract to such bidder.

IB.17 Pre-Bid Meeting

- 17.1 The Employer may, on his own motion or at the request of any prospective bidder(s), hold a pre-bid meeting to clarify issues and to answer any questions on matters related to the Bidding Documents. The date, time and venue of pre-bid meeting, if convened, is as stipulated in the Bidding Data. All prospective bidders or their authorized representatives shall be invited to attend such a pre-bid meeting.
- 17.2 The bidders are requested to submit questions, if any, in writing so as to reach the Employer not later than seven (7) days before the proposed pre-bid meeting.
- 17.3 Minutes of the pre-bid meeting, including the text of the questions raised and the replies



given, will be transmitted without delay to all purchasers of the Bidding Documents. Any modification of the Bidding Documents listed in Sub-Clause 7.1 hereof which may become necessary as a result of the pre-bid meeting shall be made by the Employer exclusively through the issue of an Addendum pursuant to Clause IB.9 and not through the minutes of the pre-bid meeting.

17.4 Absence at the pre-bid meeting will not be a cause for disqualification of a bidder.

IB.18 Format and Signing of Bid

18.1 Bidders are particularly directed that the amount entered on the Form of Bid shall be for performing the Contract strictly in accordance with the Bidding Documents.

18.2 All appendices to Bid are to be properly completed and signed.

18.3 No alteration is to be made in the Form of Bid nor in the Appendices thereto except in filling up the blanks as directed. If any such alterations be made or if these instructions be not fully complied with, the bid may be rejected.

18.4 Each bidder shall prepare by filling out the forms completely and without alterations one (1) original and number of copies, specified in the Bidding Data, of the documents comprising the bid as described in Clause IB.7 and clearly mark them "ORIGINAL" and "COPY" as appropriate. In the event of discrepancy between them, the original shall prevail.

18.5 The original and all copies of the bid shall be typed or written in indelible ink (in the case of copies, Photostats are also acceptable) and shall be signed by a person or persons duly authorized to sign on behalf of the bidder pursuant to Sub- Clause 11.1(a) hereof. All pages of the bid shall be initialed and stamped by the person or persons signing the bid.

18.6 The bid shall contain no alterations, omissions or additions, except to comply with instructions issued by the Employer, or as are necessary to correct errors made by the bidder, in which case such corrections shall be initialed by the person or persons signing the bid.

18.7 Bidders shall indicate in the space provided in the Form of Bid their full and proper addresses at which notices may be legally served on them and to which all correspondence in connection with their bids and the Contract is to be sent.

18.8 Bidders should retain a copy of the Bidding Documents as their file copy.

D. SUBMISSION OF BIDS

IB.19 Sealing and Marking of Bids

19.1 Each bidder shall submit his bid as under:

- (a) ORIGINAL and each copy of the Bid shall be separately sealed and put in separate envelopes and marked as such.



- (b) The envelopes containing the ORIGINAL and copies will be put in one sealed envelope and addressed / identified as given in Sub- Clause 19.2 hereof.

19.2 The inner and outer envelopes shall

- (a) Be addressed to the Employer at the address provided in the Bidding Data;
- (b) Bear the name and identification number of the contract as defined in the Bidding Data; and
- (c) Provide a warning not to open before the time and date for bid opening, as specified in the Bidding Data.

19.3 In addition to the identification required in Sub- Clause 19.2 hereof, the inner envelope shall indicate the name and address of the bidder to enable the bid to be returned unopened in case it is declared “late” pursuant to Clause IB.21

19.4 If the outer envelope is not sealed and marked as above, the Employer will assume no responsibility for the misplacement or premature opening of the Bid.

IB.20 Deadline for Submission of Bids

- 20.1 (a) Bids must be received by the Employer at the address specified no later than the time and date stipulated in the Bidding Data.
- (b) Bids with charges payable will not be accepted, nor will arrangements be undertaken to collect the bids from any delivery point other than that specified above. Bidders shall bear all expenses incurred in the preparation and delivery of bids. No claims will be entertained for refund of such expenses.
- (c) Where delivery of a bid is by mail and the bidder wishes to receive an acknowledgment of receipt of such bid, he shall make a request for such acknowledgment in a separate letter attached to but not included in the sealed bid package.
- (d) Upon request, acknowledgment of receipt of bids will be provided to those making delivery in person or by messenger.

20.2 The Employer may, at his discretion, extend the deadline for submission of bids by issuing an amendment in accordance with Clause IB.9, in which case all rights and obligations of the Employer and the bidders previously subject to the original deadline will thereafter be subject to the deadline as extended.

**IB.21 Late Bids**

- 21.1(a) Any bid received by the Employer after the deadline for submission of bids prescribed in Clause IB.20 will be returned unopened to such bidder.
- (b) Delays in the mail, delays of person in transit, or delivery of a bid to the wrong office shall not be accepted as an excuse for failure to deliver a bid at the proper place and time. It shall be the bidder's responsibility to determine the manner in which timely delivery of his bid will be accomplished either in person, by messenger or by mail.

IB.22 Modification, Substitution and Withdrawal of Bids

- 22.1 Any bidder may modify, substitute or withdraw his bid after bid submission provided that the modification, substitution or written notice of withdrawal is received by the Employer prior to the deadline for submission of bids.
- 22.2 The modification, substitution, or notice for withdrawal of any bid shall be prepared, sealed, marked and delivered in accordance with the provisions of Clause IB.19 with the outer and inner envelopes additionally marked "MODIFICATION", "SUBSTITUTION" or "WITHDRAWAL" as appropriate.
- 22.3 No bid may be modified by a bidder after the deadline for submission of bids except in accordance with Sub-Clauses 22.1 and 27.2.
- 22.4 Withdrawal of a bid during the interval between the deadline for submission of bids and the expiration of the period of bid validity specified in the Form of Bid may result in forfeiture of the Bid Security in pursuance to Clause IB.15.

E. BID OPENING AND EVALUATION**IB.23 Bid Opening**

- 23.1 The Employer will open the bids, including withdrawals, substitution and modifications made pursuant to Clause IB.22, in the presence of bidders' representatives who choose to attend, at the time, date and location stipulated in the Bidding Data. The bidders' representatives who are present shall sign a register evidencing their attendance.
- 23.2 Envelopes marked "MODIFICATION", "SUBSTITUTION" or "WITHDRAWAL" shall be opened and read out first. Bids for which an acceptable notice of withdrawal has been submitted pursuant to Clause IB.22 shall not be opened.
- 23.3 The bidder's name, total Bid Price and price of any Alternate Proposal(s), any discounts, bid modifications, substitution and withdrawals, the presence or absence of Bid Security, and such other details as the Employer may consider appropriate, will be announced by the Employer at the opening of bids.
- 23.4 Employer shall prepare minutes of the bid opening, including the information disclosed to those present in accordance with the Sub-Clause 23.3.

**IB.24 Process to be Confidential**

- 24.1 Information relating to the examination, clarification, evaluation and comparison of bid and recommendations for the award of a contract shall not be disclosed to bidders or any other person not officially concerned with such process before the announcement of bid evaluation report which shall be done at least ten (10) days prior to issue of Letter of Acceptance. The announcement to all

Bidders will include table(s) comprising read out prices, discounted prices, price adjustments made, final evaluated prices and recommendations against all the bids evaluated. Any effort by a bidder to influence the Employer's processing of bids or award decisions may result in the rejection of such bidder's bid. Whereas any bidder feeling aggrieved may lodge a written complaint not later than fifteen (15) days after the announcement of the bid evaluation report; however mere fact of lodging a complaint shall not warrant suspension of the procurement process.

IB.25 Clarification of Bids

- 25.1 To assist in the examination, evaluation and comparison of bids, the Employer may, at his discretion, ask any bidder for clarification of his bid, including breakdowns of unit rates. The request for clarification and the response shall be in writing but no change in the price or substance of the bid shall be sought, offered or permitted except as required to confirm the correction of arithmetic errors discovered by the Employer in the evaluation of the bids in accordance with Clause IB.28.

IB.26 Examination of Bids and Determination of Responsiveness

- 26.1 Prior to the detailed evaluation of bids, the Employer will determine whether each bid is substantially responsive to the requirements of the Bidding Documents.
- 26.2 A substantially responsive bid is one which (i) meets the eligibility criteria; (ii) has been properly signed; (iii) is accompanied by the required Bid Security; and (iv) conforms to all the terms, conditions and specifications of the Bidding Documents, without material deviation or reservation. A material deviation or reservation is one (i) which affect in any substantial way the scope, quality or performance of the Works; (ii) which limits in any substantial way, inconsistent with the Bidding Documents, the Employer's rights or the bidder's obligations under the Contract; or (iii) adoption/rectification whereof would affect unfairly the competitive position of other bidders presenting substantially responsive bids.
- 26.3 If a bid is not substantially responsive, it will be rejected by the Employer, and may not subsequently be made responsive by correction or withdrawal of the non-conforming deviation or reservation.

IB.27 Correction of Errors

- 27.1 Bids determined to be substantially responsive will be checked by the Employer for any arithmetic errors. Errors will be corrected by the Employer as follows:



- (a) Where there is a discrepancy between the amounts in figures and in words, the amount in words will govern; and
- (b) where there is a discrepancy between the unit rate and the line item total resulting from multiplying the unit rate by the quantity, the unit rate as quoted will govern, unless in the opinion of the Employer there is an obviously gross misplacement of the decimal point in the unit rate, in which case the line item total as quoted will govern and the unit rate will be corrected.

27.2 The amount stated in the Form of Bid will be adjusted by the Employer in accordance with the above procedure for the correction of errors and with the concurrence of the bidder, shall be considered as binding upon the bidder. If the bidder does not accept the corrected Bid Price, his Bid will be rejected, and the Bid Security shall be forfeited in accordance with Sub- Clause 15.6(b) hereof.

IB.28 Evaluation and Comparison of Bids

28.1 The Employer will evaluate and compare only the Bids determined to be substantially responsive in accordance with Clause IB.26.

28.2 In evaluating the Bids, the Employer will determine for each Bid the evaluated Bid Price by adjusting the Bid Price as follows:

- (a) making any correction for errors pursuant to Clause IB.27;
- (b) excluding Provisional Sums and the provision, if any, for contingencies in the Summary Bill of Quantities, but including competitively priced Day work; and
- (c) making an appropriate adjustment for any other acceptable variation or deviation.

28.3 The estimated effect of the price adjustment provisions of the Conditions of Contract, applied over the period of execution of the Contract, shall not be taken into account in Bid evaluation.

28.4 If the Bid of the successful bidder is seriously unbalanced in relation to the Employer's estimate of the cost of work to be performed under the Contract, the Employer may require the bidder to produce detailed price analyses for any or all items of the Bill of Quantities to demonstrate the internal consistency of those prices with the construction methods and schedule proposed. After evaluation of the price analyses, the Employer may require that the amount of the Performance Security set forth in Clause IB.32 be increased at the expense of the successful bidder to a level sufficient to protect the Employer against financial loss in the event of default of the successful bidder under the Contract.



F. AWARD OF CONTRACT

IB.29 Award

- 29.1 Subject to Clauses IB.30 and IB.34, the Employer will award the Contract to the bidder whose bid has been determined to be substantially responsive to the Bidding Documents and who has offered the lowest evaluated Bid Price, provided that such bidder has been determined to be eligible in accordance with the provisions of Clause IB.3 and qualify pursuant to Sub-Clause IB 29.2.
- 29.2 The Employer, at any stage of the bid evaluation, having credible reasons for or prima facie evidence of any defect in supplier's or contractor's capacities, may require the suppliers or contractors to provide information concerning their professional, technical, financial, legal or managerial competence whether already pre-qualified or not:

Provided that such qualification shall only be laid down after recording reasons therefore in writing. They shall form part of the records of that bid evaluation report.

Requirements and Financial Evaluation criteria is attached in bidding data, which shall be filled by employer. Accordingly contractor's evaluation shall be carried out.

IB.30 Employer's Right to Accept any Bid and to Reject any or all Bids

- 30.1 Notwithstanding Clause IB.29, the Employer reserves the right to accept or reject any Bid, and to annul the bidding process and reject all bids, at any time prior to award of Contract, without thereby incurring any liability to the affected bidders or any obligation except that the grounds for rejection of all bids shall upon request be communicated to any bidder who submitted a bid, without justification of grounds. Rejection of all bids shall be notified to all bidders promptly.

IB.31 Notification of Award

- 31.1 Prior to expiration of the period of bid validity prescribed by the Employer, the Employer will notify the successful bidder in writing ("Letter of Acceptance") that his Bid has been accepted. This letter shall name the sum which the Employer will pay the Contractor in consideration of the execution and completion of the Works by the Contractor as prescribed by the Contract (hereinafter and in the Conditions of Contract called the "Contract Price").
- 31.2 No Negotiation with the bidder having evaluated as lowest responsive or any other bidder shall be permitted, however, Employer may have clarification meetings to get clarify any item in the bid evaluation report.
- 31.3 The notification of award and its acceptance by the bidder will constitute the formation of the Contract, binding the Employer and the bidder till signing of the



formal Contract Agreement.

- 31.4 Upon furnishing by the successful bidder of a Performance Security, the Employer will promptly notify the other bidders that their Bids have been unsuccessful and return their bid securities.

IB.32 Performance Security

- 32.1 The successful bidder shall furnish to the Employer a Performance Security in the form and the amount stipulated in the Bidding Data and the Conditions of Contract within a period of 28 days after the receipt of Letter of Acceptance.
- 32.2 Failure of the successful bidder to comply with the requirements of Sub- Clause IB.32.1 or Clauses IB.33 or IB.35 shall constitute sufficient grounds for the annulment of the award and forfeiture of the Bid Security.

IB.33 Signing of Contract Agreement

- 33.1 Within 14 days from the date of furnishing of acceptable Performance Security under the Conditions of Contract, the Employer will send the successful bidder the Contract Agreement in the form provided in the Bidding Documents, incorporating all agreements between the parties.
- 33.2 The formal Agreement between the Employer and the successful bidder shall be executed within 14 days of the receipt of the Contract Agreement by the successful bidder from the Employer.

IB.34 General Performance of the Bidders

The Employer reserves the right to obtain information regarding performance of the bidders on their previously awarded contracts/works. The Employer may in case of consistent poor performance of any Bidder as reported by the employers of the previously awarded contracts, inter alia, reject his bid and/or refer the case to the Pakistan Engineering Council (PEC). Upon such reference, PEC in accordance with its rules, procedures and relevant laws of the land take such action as may be deemed appropriate under the circumstances of the case including black listing of such Bidder and debarring him from participation in future bidding for similar works.

IB.35 Integrity Pact

The Bidder shall sign and stamp the Integrity Pact provided at Appendix-L to Bid in the Bidding Documents for all Federal Government procurement contracts exceeding Rupees ten million. Failure to provide such Integrity Pact shall make the bidder non-responsive.



BIDDING DATA



BIDDING DATA

The following specific data for the Works to be bided shall complement, amend, or supplement the provisions in the Instructions to Bidders. Wherever there is a conflict, the provisions herein shall prevail over those in the Instructions to Bidders.

Instruction to Bidders Clause Reference

1.1 Scope of Bid:

Ref: Vol-I (BOQ)

Ref: Vol-II (SCOPE of WORK, SPECIFICATIONS & DRAWINGS)

1.2 COMPLETION TIME:

The time completion of the whole work by the construction contractor. As OGDCL has to meet its obligations for supply of Oil & Gas owing to critical energy crises being faced by the country. The work shall be completed within period of **120 days** from possession of site issue by Engineer Incharge. The delay on part of OGDCL shall be excluded from project completion time unless verified by the Engineer In-charge on daily progress format.

3.1 (c) LIST OF PRE-QUALIFIED CONTRACTORS:

List of pre-qualified contractors attached at *sheet 2 of 4 in "Invitation for Bid"*.

8.1 Time limit for clarification:

In Line 4, delete the following text:

“The Employer will respond to any request for clarification which he receives earlier than 15 days prior to the deadline for submission of bids”.

and replace with the following:

No request for clarification will be entertained/received later than **five working days (05)** days prior to the date fixed for submission of the bid. The Employer’s response will be made not later than 3 days prior to the date fixed for submission of a bid.

9 Amendment in Bidding Documents:

9.2 In Line 2, delete the following text:

“Shall be communicated in writing to all purchasers of the Bidding Documents. Prospective bidders shall acknowledge receipt of each addendum in writing to the Employer”



and replace with the following:

Shall be provided to all pre-qualified bidders.

10.1 Bid Language:

English

11 Documents accompanying the bid:

11.1 (b) (vi)

➤ **Financial Bid** shall consist on the basis of minimum but not limited to the followings:

- Bidding Form (Original) – Sign and Stamp
- BOQ (Original) – Sign and Stamp
- Valid PEC License in C-4 Category
- Compliance Sheet – **Annexure-I**

13 Bidders to quote entirely in **Pak Rupees** only and no foreign currency are admissible.

14.1 Period of Bid Validity:

180 days from the submission/opening of the Bids.

15 Bid Security:

15.1 Bid must be accompanied by a Bid Bond of Minimum amount i.e., **PKR 2.5 Million** in the form of Cash Deposit Receipt (CDR) or a Bank Draft or a Bank Guarantee issued by scheduled Bank of Pakistan or a branch of Foreign Bank operating in Pakistan.

15.2 Bid Bond Bank Guarantee will not be acceptable with the banks whose market price per share is quoted below the par value at the Stock Exchange.

15.3 Bid Security is valid for **210 Days** from the date of Technical Bid Opening.

15.4 The Bid Security may be forfeited:

- (a) If the bidder withdraws his bid except as provided in Sub-Clause 22.1;
- (b) If the bidder submits forged or fake bidding documents
- (c) If the bidder does not accept the correction of his Bid Price pursuant to Sub- Clause 27.2 hereof; or
- (d) Fails to execute the Contract in accordance with the tender document; or
- (e) In the case of the successful bidder, if he fails within the specified time limit to:



- Furnish the required Performance Security; Advance Bank Guarantee or
 - Sign the Contract Agreement.
- (f) In case of any loss or damage suffered by the Purchaser due to any of the aforementioned act of the bidder(s) is more than the Liquidated Damages, the Purchaser will be entitled to recover the losses through encashment of Bid Securities/ Bank Guarantee(s)/Earnest Money or forfeiture of Security furnished by the bidder in other procurement cases
- (g) Any other reason warranting the confiscation of the guarantee.

17.1 **PRE-BID MEETING:**

A pre-bid meeting will be arrange **before 10days** of opening for the purpose of clarifying issues and answering questions on any matter that may be raised at that stage. Bidders or their official representatives are advised to attend the conference which will be held in the office of:

MANAGER (PIPELINE & FABRICATION)
Room#21, 1st Floor, Engineering Department, Masood
Mansion F-8 Markaz, Islamabad.
Phone# 051-9261293

19.0 **Sealing and Marking of Bids**

Employer is following **Single Stage- One Envelop bidding process as per PPRA** .

19.2 The outer sealed envelope shall be marked and addressed as follows:

Manager (Local) Procurement, SCM Department,

OIL AND GAS DEVELOPMENT COMPANY LIMITED (OGDCL)

OGDCL House, Jinnah Avenue Islamabad.

Phone # 92-51-920023750, Fax # 92-51-9215090

DO NOT OPEN BEFORE _____ **Date** _____

The sealed envelope shall indicate the name and address of the Bidder to enable the bid to be returned unopened in case it is declared LATE.

Employer shall not be responsible for the premature opening or misplacement of any Bid not clearly marked and addressed in accordance with Instruction above.

20.1(a) Deadline for submission of bids:

“The bids can be delivered in the mentioned office on the schedule mentioned and the same will be opened accordingly in presence of bidder’s representative.”

23.1 Venue, time, and date of Bid opening:

As per announcement



28.5 The Employer reserves the right to accept or reject any variation, deviation or alternative offer.

29.3 **FINANCIAL EVALUATION CRITERIA**

The contract will be awarded to only one bidder who technically responsive and declare lowest among bidders as per given format in **Annexure-II**

32.1 Form and amount of Performance Security/Bank Guarantee acceptable to the Employer: Bank Guarantee from any Scheduled Bank of Pakistan for an amount equal to 10% of the total Contract Price stated in the Letter of Acceptance. Performance Bond Bank Guarantee will not be acceptable with the banks whose market price per share is quoted below the par value at the Stock Exchange



ANNEXURE – I
COMPLIANCE SHEET

**COMPLIANCE SHEET**

SR#	DESCRIPTION	COMPLY / NOT COMPLY
1	Covering Letter	
2	General Information	
3	Authority letter on company / JV letter head.	
4	Pakistan Engineering Council (Category C-4 and above)	
5	Bid Validity - 180 Days (Ref: Clause 14 of Bidding Data)	
6	Compliance Sheet (Annexure-I)	
7	Bid Security – Rs 2.5 Million (Ref: Clause 15 of Bidding Data)	
8	Original Bid Security (Submitted along with Financial Bid)	
9	Bid Security Validity – 210 Days (Ref: Clause 15 of Bidding Data)	
10	Completion Time – 120 Days (Ref: Clause 1.2 of Bidding Data)	
11	Working methodology, plan and procedure	
12	Organogram & Equipment deployment List	
13	Project Schedule / Gantt Chart	
14	Format for Daily, weekly and monthly report acceptable to Employers Engineer In charge.	
15	Affidavit as per given format (On Rs 100/- Stamp Paper)	
16	Integrity Pact as per given format (On Rs 100/- Stamp Paper)	
17	Bidding Form as per given format	
18	All bidding documents will be fully sign and stamp (1 Original + 1 Copy) by authorized person / lead partner. In case of JV, must be sign & Stamp	



	by each partner.	
19	No deviation & conditional bid shall be accepted.	
20	Radiography & 3 rd Party Inspection shall be arranged by OGDCL as its own cost as per SCOPE of WORK, BOQ, Drawings and standard practice and qualified procedures. Contractor shall comply that any sort of information and documents required by Inspector and/or Engineer In-charge before, during and after execution of work shall be provided and any deficiency, defect, remedy identify shall be rectify at the cost of Contractor.	
21	Written approval require from Engineer Incharge before starting any construction works.	

** Bidder(s) may add further JV partner details as per above format.*

Sign & Stamp
(By Bidder's)



ANNEXURE – II
FINANCIAL EVALUATION CRITERIA



FINANCIAL EVALUATION CRITERIA

#	Project Description	1 st Lowest Bidder		2 nd Lowest Bidder		3 rd Lowest Bidder	
		Rate (Rs.)	Amount (Rs.)	Rate (Rs.)	Amount (Rs.)	Rate (Rs.)	Amount (Rs.)
1	Mechanical Works						
2	Grand Total with all taxes Exclusive of PST/ICT						
3	Rate and Amount of PST/ICT on above mentioned Services @%						
4	Grand Total Inclusive of All Applicable Taxes with PST/ICT						



BIDDING FORM,
APPENDICES TO BID
AND
AFFIDAVIT



BIDDING FORM

Date.....
Tender Enquiry No.

To
Oil & Gas Development Company Limited,

**OGDCL House, Plot # 3013,
Blue Area, Islamabad
Gentlemen,**

Having examined the conditions of contract, scope of work and Instructions to bidders of Invitation to Bids, the receipt of which is hereby acknowledged, we the undersigned, offer to perform services (Nature of Service) to OGDCL in conformity with the scope of work and Instructions to bidders at the rates mentioned in our Bid Proposal or other such sums as may be ascertained in accordance with the said conditions.

2. We confirm that the terms and conditions given in the Tender Enquiry / Tender Documents are acceptable to us and if our Bid is accepted we shall execute a contract with OGDCL accordingly without any exceptions. We further confirm to commence service withindays of the mobilization notice issued by OGDCL.

3 We agree to validate bid unconditionally for the period of 180 days from the date of opening the same and it shall remain binding upon us and may be accepted thereof, shall constitute a binding contract between us.

4. We hereby certify that our Firm / Company / Local Agent is or has not been at any time during the past five years, involved in litigation, arbitration or any other unsettled dispute with OGDCL / JV Partners.

5. We further certify that all the contracts / orders placed on us by OGDCL / JV Partners have been executed timely and as per terms & conditions of the Contract / order without any unsettled dispute.

6. Until a formal Agreement is prepared and executed, this bid, together with your acceptance thereof, shall constitute a binding contract between us.

7. We understand that you are not bound to accept the lowest or any tender you may receive.

8. Our bid proposal do not contain any deviation or exceptions from the terms & conditions enunciated in the tender documents.

Dated this.....days of..... (year) 20--,

Name & Signature.....in the Capacity of.....

duly authorized to sign tenders for and on behalf of.....
(Name of the firm in block capital Letters)

Address.....

Telex No.....Fax No.....Phone No.....

Witness

1.
(Name)

(Signature)

2.
(Name)

(Signature)

**SPECIAL STIPULATIONS Clause**

1.	Engineer's Authority to issue Variation in emergency	2.1	To convey after approval in accordance with the rules and regulations of the Employer.
2.	Minimum Amount of Performance Security	10.1	10% of total Contract Price stated in the Letter of Acceptance in the form of bank guarantee.
3.	Time for Furnishing Programme	14.1	Within 10 days from the date of receipt of Letter of Acceptance.
4.	Minimum amount of Third Party Insurance	23.2	Rs. 500,000/- (Five Hundred Thousands) per Occurrence with number of occurrences unlimited.
5.	Time for Commencement	41.1	Within 07 days from the date of receipt of Engineer's Notice to Commence.
6.	Time for Completion	43.1, 48.2	120 days Calendar days from the date of receipt of Engineer's Notice to Commence.
7.	Amount of Liquidated Damages	47.1	0.1 % of the Contract Price for each day of Delay in completion of the Works subject to a maximum of 10% of Contract Price stated in the Letter of Acceptance.
8.	Defects Liability Period	49.1	One (01) Year from the effective date of Taking Over Certificate.
9.	Percentage of Retention Money	60.2	10% of the amount of Interim Payment Certificate.
10.	Limit of Retention Money	60.2	5 % of Contract Price stated in the Letter of Acceptance.
11.	Time of Payment from delivery of Engineer's Interim Payment Certificate	60.10	As per Employer's procedure.
12.	Mobilization Advance * (Interest Free)	60.12	10% of Contract Price stated in the Letter of Acceptance subject to provision of B/G from scheduled banks of Pakistan
13.	Price Adjustment Clause		This Clause is deleted and no escalation Allowed.
14.	Bid Security		PKR 2.5 Million in the form of pay order or demand draft or Bank Guarantee must accompany with the bids.

* Delete if alternative one is not adopted.



PANDHI & BALOCH#1

Appendix-D to Bid

BILL OF QUANTITIES

(Attach Separately)

**PROPOSED CONSTRUCTION SCHEDULE**

Pursuant to Sub-Clause 43.1 of the General Conditions of Contract, the Works shall be completed on or before the date stated in Appendix-A to Bid. The Bidder shall provide as Appendix-E to Bid, the Construction Schedule in the bar chart (CPM, PERT or any other to be specified herein) showing the sequence of work items and the period of time during which he proposes to complete each work item in such a manner that his proposed programme for completion of the whole of the Works and parts of the Works may meet Employer's completion targets in days noted below and counted from the date of receipt of Engineer's Notice to Commence (Attach sheets as required for the specified form of Construction Schedule):

Description**Time for Completion**

Whole Works

120 days



BF-1

Appendix-F to Bid

METHOD OF PERFORMING THE WORK

[The Bidder is required to submit a narrative outlining the method of performing the Work. The narrative should indicate in detail and include but not be limited to:

1. Organization Chart indicating head office and field office personnel involved in management and supervision, engineering, equipment maintenance and purchasing.
2. Mobilization in Pakistan, the type of facilities including personnel accommodation, office accommodation, provision for maintenance and for storage, communications, security and other services to be used.
3. The method of executing the Works, the procedures for installation of equipment and machinery and transportation of equipment and materials to the site.]



BG-1

Appendix-G to Bid

LIST OF MAJOR EQUIPMENT – RELATED ITEMS

(To be used by the Bidder)

[The Bidder will provide on Sheet 2 of this Appendix a list of all major equipment and related items, under separate heading for items owned, to be purchased or to be arranged on lease by him to carry out the Works. The information shall include make, type, capacity, and anticipated period of utilization for all equipment which shall be in sufficient detail to demonstrate fully that the equipment will meet all requirements of the Specifications.]



BH-1

Appendix-H to Bid

CONSTRUCTION CAMP AND HOUSING FACILITIES

The Contractor in accordance with Clause 34 of the Conditions of Contract shall provide description of his construction camp's facilities and staff housing requirements.

The Contractor shall be responsible for pumps, electrical power, water and electrical distribution systems, and sewerage system including all fittings, pipes and other items necessary for servicing the Contractor's construction camp.

The Bidder shall list or explain his plans for providing these facilities for the service of the Contract as follows:

1. Site Preparation (clearing, land preparation, etc.).
2. Provision of Services.
 - a) Power (expected power load, etc.).
 - b) Water (required amount and system proposed).
 - c) Sanitation (sewage disposal system, etc.).
3. Construction of Facilities
 - a) Contractor's Office, Workshop and Work Areas (areas required and proposed layout, type of construction of buildings, etc.).
 - b) Warehouses and Storage Areas (area required, type of construction and layout).
 - c) Housing and Staff Facilities (Plans for housing for proposed staff, layout, type of construction, etc.).
4. Construction Equipment Assembly and Preparation (detailed plans for carrying out this activity).
5. Other Items Proposed (Security services, etc.).



BI-1

Appendix-I to Bid

LIST OF SUBCONTRACTORS

I/We intend to subcontract the following parts of the Work to subcontractors. In my/our opinion, the subcontractors named hereunder are reliable and competent to perform that part of the work for which each is listed.

Enclosed are documentation outlining experience of subcontractors, the curriculum vitae and experience of their key personnel who will be assigned to the Contract, equipment to be supplied by them, size, location and type of contracts carried out in the past.

Part of Works (Give Details)	Subcontractor (With Complete Address)
1	2



PANDHI & BALOCH#1

BJ-1

Appendix-J to Bid

ESTIMATED PROGRESS PAYMENTS

Payment will be made on actual work done bases.



PANDHI & BALOCH#1

BK-1

Appendix-K to Bid

**ORGANIZATION CHART FOR THE
SUPERVISORY STAFF AND LABOUR**



PANDHI & BALOCH#1

Appendix-L to Bid

LIST OF BIDDER DRAWINGS

(Bidder Drawings are Attached Separately as Volume-III)



(On official letter-head of the bidder)
To be signed by the
Chief Executive of the
Bidding company or a representative duly
Authorized by board
Resolution.

INTEGRITY AND ETHICS UNDERTAKING

We hereby commit and undertake to observe the following principles during our participation in the tender process and during the contract execution:

- i. That we will not directly or through any other person of firm, officer promise or give to any of the employees of OGDCL involved in the tender process or execution of the contract any gain, pecuniary benefit of facilitation payment in order to obtain in exchange any advantages of any kind whatsoever during the tender process or during the execution of contracts.
- ii. That we have not and will not enter with other bidders into any undisclosed agreement or undertaking either formal or informal to restrict competitiveness sort to cartelise in the bidding process.
- iii. That we will ensure that the remuneration of agents (if engaged) is appropriate and for legitimate services only.
- iv. That we will not use subcontracts, purchase orders or consulting agreements as means of channeling payments to employees of OGDCL.
- v. That we will not commit any offence under the Pakistan Penal Code, Prevention of Corruption Act or National Accountability Ordinance to achieve any advantage, gain or benefit during the tender process or the execution of the contract.

We further understand and acknowledge that any violation of transgression of the above mentioned principles will attract disqualification from the tender process and may also result in permanent exclusion from future contract award process.

We also accept and undertaking to respect and uphold OGDCL,s absolute right to resort to and impose such disqualification, debarment or execution.

For and on behalf of _____

Tender No _____



A F F I D A V I T
(To be attached with Technical bid)

I, _____ S/o _____ aged _____ years
_____ working as Proprietor/Managing Partner/Director of M/s _____
_____ having its registered office at _____ do hereby solemnly affirm
and declare on oath as under:

1. That I am competent to swear this affidavit being proprietor/one or the partners/
Director of M/s _____
2. That M/s _____ is a
proprietorship/partnership firm/company is participating in tender process
conducted by OGDCL.
3. That I hereby confirm and declare that none of my/our group/sister
concern/associate company is participating/ submitting this tender.
4. That I hereby confirm and declare that my/our firm/company M/s
_____ and my/our firm/group/company/ sister concern /
associate company **or any of its directors have not been black listed/de-listed by any
Institutional agencies/Govt. Deptt/ Public Sector Undertaking.**
5. That there is no change in the Name & Style, Constitution and Status of the firm, after
Pre-qualification.
6. That I further undertake that in case any of the facts contained above and in-our
application is round other-wise or incorrect or false at any stage, my/our
firm/company/ group/sister concerns/ associate companies shall stand debarred
from the present and future tenders of the OGDCL.

(Signature of the Proprietor/ Managing Partner/Director with Seal)

DEPONENT

Verified at _____ on _____ that the contents of paras 1 to 6 of
this affidavit are true and correct to best of my knowledge and no part of this is false and nothing
material has been concealed or falsely stated therein.

(Signature of the Proprietor/ Managing Partner/ Director with Seal)

DEPONENT

(Signature & Seal of Notary)



FORMS

**INDEMNITY BOND
BID BOND
PERFORMANCE SECURITY
CONTRACT AGREEMENT
MOBILIZATION ADVANCE GUARANTEE/BOND**



INDEMNITY BOND FOR SECURED ADVANCE
AGAINST THE MATERIALS FINANCED / PAID BY THE
OIL & GAS DEVELOPMENT COMPANY LIMITED (OGDCL) (EMPLOYER)

INTERIM PAYMENT CERTIFICATE NO. _____

This indemnity Bond is signed, executed & issued at _____. This _____ day of _____ by _____ having its office at _____ (hereinafter called the Contractor) in favour of the OIL & GAS DEVELOPMENT COMPANY LIMITED (OGDCL) having its office at Piran ghaib road Multan. (hereinafter called the Employer).

AND WHEREAS the Contractor entered into a written Contract Agreement with the Employer dated the _____ Day of _____ for Construction of -----

AND WHEREAS the Contractor seeks Secured Advance payment from the Employer pursuant to Sub-Clause 60.11 of GCC Secured Advance on Materials' of the conditions of contract ; and the contractor has brought the following materials at the site for incorporation in the Permanent Works, and the materials have not yet been incorporated in the Permanent Works,

AND WHEREAS the Contractor undertakes and solemnly affirms that:

1. The materials are in compliance with the Technical specifications for the Permanent Works,
2. The materials have been delivered to the site and are properly stored and protected against loss or damage or deterioration,
3. The Contractor's records of the requirements, orders, receipts and use of materials at the site are kept in a form approved by the Employer, and such records shall be available for inspection by the Employer,
4. Ownership of the materials shall be deemed to vest in the Employer, and these materials shall not be removed from the site or otherwise disposed of without written permission of the Employer, and
5. The Contractor will not pledge any of the materials with any Bank or like agency or any individual.

NOW THEREFORE, through this Indemnity Bond the Contractor binds himself to exonerate, save harmless, indemnify and keep indemnified the Employer for and against any and all losses of whatsoever kind and nature relating to the materials including those due to theft, loot, arson, pilferage, wastage due to fire, rains, storm, earthquake, flood and inundation, shortage, damage,



deterioration and depreciation etc., of the materials, through any act of man or God, or slump in the market of the materials, financed,

Advanced or paid by the Employer on the Contractor's Request for financing / advancing/ payment.

The Contractors further declares that he will faithfully abide by the above declaration; and that in the event of his infringement of the declaration made above, the Employer will be fully entitled forfeit all such material and also proceed against the Contractor according to the relevant clause pertaining to breach of Contract and further invoke the power to seek any remedies accrued to him as the Employer under the Contract.

Further, the Contractor also authorizes the Employer to adjust the Secured Advance payment amount in full or in part from any of the Contractor's payment Certificates/bills, or adjust for the actual incorporation of these materials in the Permanent Works, without having to make any reference to the Contractor.

Details of the materials and their cost for which Secured Advance payment is being sought by the Contractor are as under:

S. No.	Type of Material	Qty in M.Ton.	@ Avg.	Amount in Rs.
01	_____	_____	_____	_____
02	_____	_____	_____	_____
	_____Advance Cost of Material at site.			_____
			TOTAL Rs.	_____

Rupees _____

Seal and Signature of the Contractor

Witnesses:

1. _____

2. _____

3. _____

**BID BOND**

Oil & Gas Development Company Limited, Guarantee No.....
OGDCL House, Jinnah Avenue, Date of issue.....
Blue Area, Islamabad. Date of expiry.....
Amount.....

Dear Sir,

In consideration of M/s.....
herein after called "THE BIDDER" having submitted the accompanying Bid with
reference to OGDCL tender enquiry No. **PROC-SERVICES/**-----and
in consideration of value received from (the Bidder above), we hereby agree to
undertake as follows:-

1. To make unconditional, immediate and forthwith payment of the sum of -----
-- upon your FIRST and SIMPLE written demand without further recourse,
question, query, deferment, contestation or reference to the bidder, account party
or any other person in the event of the withdrawal of the aforesaid bid by the
BIDDER before the end of the period specified in the Bid after the opening of the
same for the validity thereof or if no such period be specified, within 210 days
after the said opening or if the Bidder, having been notified of the acceptance of
his bid by the Company during the period of bid validity:
 - i. Fails, refuses or delays to execute contract as per Tender/Contract's
terms & conditions.
OR
 - ii. Fails, refuses or delays to furnish Performance Bond and/or Advance
Bank Guarantees.
OR
 - iii. Submit forged/fake document(s) in support of their bid.
OR
 - iv. Fails to provide/ perform services as specified in TOR.
2. To accept written intimation from you as conclusive, sufficient and final
evidence of the existence of a default of non-compliance, breach or default
as aforesaid on the part of the BIDDER and to make payment immediately
and forthwith upon receipt of your FIRST and SIMPLE written intimation.
3. No grant of time or other indulgence to, or composition or arrangement
with the BIDDER in respect of the aforesaid Bid with or without notice to
us shall affect this Guarantee and our liabilities and commitments
hereunder.
4. This is an independent and direct obligations guarantee and shall be
binding on us and our successor in interest and shall be irrevocable.
5. The Guarantor Bank warrants and represents that it is fully authorized,
empowered and competent to issue this guarantee.

**Yours faithfully,
(BANKERS)**

**Bank guarantee issued from banks mentioned in clause#15.1 of invitation to bid
will be preferred**



PERFORMANCE BOND/BANK GUARANTEE

Oil & Gas Development Company Limited,
OGDCL House, Jinnah Avenue,
Blue Area, Islamabad.

Guarantee No.....
Date of issue.....
Date of expiry.....
Amount.....

Dear Sir,

Ref: Our Bank Guarantee No. _____ in the sum of _____
Account _____ Amount of Contract _____

In consideration of you having entered into contract No. _____ with _____ called Contractor and in consideration for value received from CONTRACTOR, we _____ at the request of _____ hereby agree and undertake as follows:

1. To make unconditional, immediate and forthwith payment to you as called upon of an amount (equivalent to 10% of total contract value in Pak Rupees/USD) on your written FIRST and SIMPLE demand without further recourse, question, query, deferment, contestation or reference to CONTRACTOR or any other person, in the event of default, non-performance or non-fulfillment by CONTRACTOR of his obligations liabilities, responsibilities, or in case if any forged or fake documents is found at any stage under this contract, of which you shall be the sole and absolute judge.
2. To accept written intimation from you as conclusive, sufficient and final evidence of the existence of a default or breach as aforesaid on the part of CONTRACTOR and to make payment immediately and forthwith upon receipt of your FIRST and SIMPLE written demand.
3. To keep this Guarantee in full force from the date hereof **until six months beyond the contract validity period.**
4. That no grant of time or other indulgence to, amendment in the terms of the contract by Agreement between the parties, or imposition or Agreement with contractor in respect of the performance of his obligation under and in pursuance of the said Agreement with or without notice to us, shall in any manner discharge or otherwise affect this Guarantee and our liabilities and commitments there under.
5. This is an independent and direct obligations guarantee and shall be binding on us and our successor interest and shall be irrevocable.
6. This Guarantee shall not be affected by any change in the constitution of the Guarantor Bank or the constitution of the Contractor.
7. The Guarantor Bank warrants and represents that it is fully authorized, empowered and competent to issue this guarantee.

Authorized Sign for Issuing Bank

Seal of the Bank

**CONTRACT AGREEMENT****CA-1**

This agreement (Hereinafter called the “Contract”) made on Day of, 20 between Oil and Gas Development Company Ltd, Islamabad (Hereinafter called “The Employer”) of the one part, represented by **Mr.** _____ and **M/S** _____ (Hereinafter called “Contractor”) of the other part and represented by **Mr.** _____ of the **M/S** _____.

WHEREAS, the employer is desirous that certain Pipeline works should be executed.

Viz:- “_____.”

NOW THIS AGREEMENT WITNESSETH as follows:-

1. In this contract agreement words and expressions shall have the same meanings as are respectively assigned to them in the condition of contract hereinafter referred to.
2. The following documents specifically applicable to the said works shall be deemed to form and be ready and construed, as part of this contract agreement, and together with this agreement contract shall hereinafter be referred to as the contract documents. The order in which the documents are listed shall be indicative as to their priority in the event of (hereinafter referred to as “contract documents”):
 - i.* Contract Agreement.
 - ii.* Work Order
 - iii.* Letter of Acceptance.
 - iv.* LOI.
 - v.* Authority Letter.
 - vi.* JV Agreement with Responsibility Matrix (If any)
 - vii.* Affidavit
 - viii.* Integrity Pact
 - ix.* Form’s
 - x.* Ethic Undertaking
 - xi.* Proposed construction schedule with Gantt Chart
 - xii.* Method of Performing the work
 - xiii.* Camping arrangements
 - xiv.* Organization Chart
 - xv.* Technical Specifications
 - xvi.* All Drawings
 - xvii.* Priced BOQ
 - xviii.* Compliance Sheet.
 - xix.* Bidding data
 - xx.* Special Stipulations.
 - xxi.* Particular Condition of Contract.



- xxii.** General Condition of Contract.
xxiii. Construction programme for execution of work over total period of _____ days.
xxiv. Instruction to Tenders.
xxv. Invitation of tenders.

3. The laws of Pakistan shall be the governing laws for this contract. This Contract shall have precedence over all other mentioned at Article 2 herein above.
4. In consideration of the payments to be made by the Employer to the contractor as hereinafter mentioned the contractor hereby covenant with the Employer to execute, complete and maintain the works in conformity in all respect with the provisions of the contract and the contract documents within the contract period.
5. The employer hereby covenant to pay the contractor in consideration of the execution, completion and maintenance of the works the contract price at the times, and in the manner prescribed by the contract documents.
6. Payment of all running bills and final bill shall be paid within the time as required by OGDCL. No interest shall be paid to the contractor for any delay in payment at OGDCL part.
7. Contractor is required to mobilize within Fourteen (14) days from the date of issuance of the work order/ Engineers Notice to proceed.
8. The supervising officer will undertake to approve all contractors' material(s) and shop drawing submittals within Fourteen (14) days or sooner, from the date of their receipt.
9. There shall be no restriction by the Employer for the overtime working of the contractor necessary to complete the works within the required time schedule and the attendance by the Employer's representative at time outside normal working hours to monitor and inspect the works will be given freely upon reasonable notification. This assistance shall not be construed to mean permanent working and therefore permanent attendance outside the supervising officer's normal working hours.

Contract Cost Rs. _____ (Pk Rupee _____) (**In**

Words) _____) *inclusive of all Tax's, duties, levies except provincial sales tax (PST) / ICT where applicable, which shall be paid / borne by OGDCL as actual.* The contractor undertakes that no claims on account of market fluctuation will be entertained during the term of the contract for any item of work included in the schedule of Quantities annexed. The contractor shall not request for escalation of rates throughout the term of contract.

CONTRACT PERIOD: - Calendar days from date of the site possession.



- 10. In case of default of the contractor and/or any of its sub contractors and/or any violation of the terms and conditions of the contract and the contract documents by the contractor and/or any of its contractors the work will be done at the risk & cost of the contractor as per Engineering Practice.
- 11. Contractor shall provide performance Bond in the shape of a pay order/Bank Guarantee from a Scheduled bank of Pakistan @ 10% of the bid Price.
- 12. The performance Bond shall remain valid from date of commencement till date of completion of work.
- 13. Anything not mentioned/clarified herein, in such eventuality the terms and conditions of the contract documents shall apply.

IN WITNESS whereof the parties hereto have caused their respective common seals to be hereunto affixed (or have hereunto set their respective hand and seals) the day and year first above written.

For and on behalf of OGDCL

Mr. _____

Designation _____

For and on behalf of the Contractor

Mr. _____

M/S _____

In Present of Witnesses:-

1. Mr. _____

CNIC# _____

1. Mr. _____

CNIC# _____

2. Mr. _____

CNIC# _____

2. Mr. _____

CNIC# _____



MG-1

MOBILIZATION ADVANCE GUARANTEE

Guarantee No. _____
Amount of Guarantee _____ Expiry
date _____
Beneficiary: OGDCL, Islamabad

WHEREAS The Oil & Gas Development Company Limited (OGDCL) (hereinafter called the 'Employer') has entered into a Contract for
- With M/S called
the 'Contractor')

AND WHEREAS, the Employer has agreed to advance to the Contractor, at the Contractor's request, an amount of Rupees _____ (Rs in Words) which amount shall be advanced to the Contractor as per provisions of the Contract.

AND WHEREAS, the Employer has asked the Contractor to furnish Guarantee to fully secure the mobilization advance for the performance of his obligations under the said Contract.

AND WHEREAS, _____
(Scheduled Bank in Pakistan acceptable to the Employer)
(Hereinafter called the "Guarantor") at the request of the Contractor and in consideration of the Employer agreeing to make the above advance to the Contractor, has agreed to furnish the said Guarantee for the amount of(say.....) as security for the fulfillment by the Contractor of their obligations under the Contract and for the reimbursement of any damages which the Employer may suffer as a result of any failure on the part of the Contractor to fulfill their obligations under the contract.

NOW, THEREFORE, the Guarantor hereby guarantees that the Contractor shall use the advance for the purpose of above mentioned Contract and if he fails and commits default in fulfilment of any of his obligations for which the advance payment is made, the Guarantor shall be liable to the Employer for payment not exceeding the aforementioned amount.

Notice in writing of any default, of which the Employer shall be the sole and final judge, on the part of the Contractor, shall be given by the Employer to the Guarantor, and on such first written demand, payment shall be made by the Guarantor of all sums then due under this Guarantee without any reference to the Contractor and without any objection. This Guarantee shall remain in force until the advance is fully adjusted against payments from the Interim Payment Certificates of the



Contractor or until _____ whichever is earlier.

The Guarantor Bank hereby further declares and guarantees independently, unconditionally and irrevocably for immediate payment of full amount of advance payment upon Employer’s **first** and **simple** written demand without making any reference, recourse to Contractor, account Party or any other person and without any question, query and contestation, in case the Contractor does not fulfill their obligations or in case the contract has been annulled, non-execution of the contract or cancellation of the contract or the contract cannot be executed because of Force Majeure or if the contract turns out to be void or unenforceable. Employer, in this regard, shall be the sole, absolute and final judge.

MG-2

The Guarantor's liability under this Guarantee shall not in any case exceed the sum of Rupees _____ (Rs _____). This Guarantee shall expire on _____ 20__ hours Pakistan Time. Any request for payment under the terms of this guarantee must therefore be received by the Bank prior to this time.

For Guarantor Bank Seal

Witness;

Manager:

1. Name: _____

1. Authorized Signature _____

Title: _____

2. Name: _____

Address: _____

3. Title: _____

2. Name: _____

4. In the capacity of: _____

Title: _____

5. In the presence of: _____

Address: _____



PART – I
GENERAL CONDITIONS OF CONTRACT



PART – I

GENERAL CONDITIONS OF CONTRACT

Definitions and Interpretation

1.1 Definitions

In the Contract (as hereinafter defined) the following words and expressions shall have the meanings hereby assigned to them, except where the context otherwise requires:

- (a) (i) "Employer" means Oil & Gas Development Company Limited (OGDCL), who will employ the Contractor and the legal successors in title to the Employer, but not except with the consent of the Contractor any assignee of the Employer.
- "Contractor" means the person or persons, firms, company or Joint Venture whose tender has been accepted by the Employer and includes the Contractor's personal representatives, successors and permitted assigns.
 - "Subcontractor" means any person named in the Contract as a Subcontractor for a part of the Works or any person to whom a part of the Works has been subcontracted with the consent of the Engineer and the legal successors in title to such person, but not any assignee of any such person.
 - "Engineer" means the person appointed by the Employer (in writing) to act as Engineer for the purposes of the Contract and named as such in Part II of these Conditions.
 - "Engineer's Representative" means a person appointed from time to time by the Engineer under Sub-Clause 2.2.
- (b) (i) "Contract" means these Conditions (Parts I and II), the Specification, the Drawings, the Bill of Quantities, the Tender, the Letter of Acceptance, the Contract and The performance Bond.
- (ii) "Specification" means the specification of the Works included in the Contract and any modification thereof or addition thereto made under Clause 51 or submitted by the Contractor and approved by the Engineer.
-



- (iii) "Drawings" means all drawings, calculations and technical information of a like nature provided by the designer / contractor under the Contract and all drawings, calculations, samples, patterns, models, operation and maintenance manuals and other technical information of a like nature submitted by the Contractor and approved in writing by the Employer.



- (iv) "Bill of Quantities" means the priced and completed bill of quantities forming part of the Tender.
 - (v) "Tender" means the Contractor's priced offer to the Employer for the execution and completion of the Works and the remedying of any defects therein in accordance with the provisions of the Contract, as accepted by the Letter of Acceptance.
 - (vi) "Letter of Acceptance" means the formal acceptance by the Employer of the Tender.
 - (vii) "Contract" means the contract (if any) referred to in Sub-Clause 9.1.
 - (viii) "Appendix to Tender" means the appendix comprised in the form of Tender annexed to these Conditions.
- (c) (i) "Commencement Date" means the date upon which the Contractor receives the notice to commence issued by the Engineer pursuant to Clause 41.
- (ii) "Time for Completion" means the time for completing the execution of and passing the Tests on Completion of the Works or any Section or part thereof as stated in the Contract (or as extended under Clause 44) calculated from the Commencement Date.
- (d) (i) "Tests on Completion" means the tests specified in the Contract or otherwise agreed by the Engineer and the Contractor which are to be made by the Contractor before the Works of any Section or part thereof are taken over by the Employer.
- (ii) "Taking-Over Certificate" means a certificate issued pursuant to Clause 48.
- (e) (i) "Contract Price" means the sum stated in the Letter of Acceptance as payable to the Contractor for the execution and completion of the Works and the remedying of any defects therein in accordance with the provisions of the Contract.
- (ii) "Retention Money" means the aggregate of all monies retained by the Employer pursuant to Sub-Clause 60.2(a).
- (iii) "Interim Payment Certificate" means any certificate of payment issued by the Engineer other than the Final Payment Certificate.
- (iv) "Final Payment Certificate" means the certificate of payment issued by the Engineer pursuant to Sub-Clause 60.8.



- (f) (i) "Works" means the Permanent Works and the Temporary Works or either of them as appropriate.
- (ii) "Permanent Works" means the permanent works to be executed (including Plant) and maintained in accordance with the Contract
- (iii) "Temporary Works" means all temporary works of every kind required in or about the execution and completion of the Works and the remedying of any defects therein.
- (iv) "Plant" means machinery, apparatus and the like intended to form or forming part of the Permanent Works.
- (v) "Contractor's Equipment" means all appliances and things of whatsoever nature (other than Temporary Works) required for the execution and completion of the Works and the remedying of any defects therein, but does not include Plant, materials or other things intended to form or forming part of the Permanent Works.
- (vi) "Section" means a part of the Works specifically identified in the Contract as a Section.
- (vii) "Site" means the places provided by the Employer where the Works are to be executed and any other places as may be specifically designated in the Contract as forming part of the Site.
- (g) (i) "cost" means all expenditure properly incurred or to be incurred, whether, on or off the Site, including overhead and other charges properly allocable thereto but does not include any allowance for profit.
- (ii) "day" means calendar day.
- (iii) "foreign currency" means a currency of a country other than that in which the Works are to be located.
- (iv) "writing" means any hand-written, type-written, or printed communication, including telex, cable and facsimile transmission.

1.2 Headings and Marginal Notes

The headings and marginal notes in these Conditions of Contract shall not be deemed to be part thereof or be taken into consideration in the interpretation or construction thereof or of the Contract.

1.3 Interpretation

Words importing persons or parties shall include firms and corporations and any organization having legal capacity.



1.4 Singular and Plural

Words importing the singular only also include the plural and vice versa where the context requires.

1.5 Notices, Consents, Approvals, Certificates and Determinations

Wherever in the Contract provision is made for the giving or issue of any notice, consent, approval, certificate or determination by any person, unless otherwise specified such notice, consent, approval, certificate or determination shall be in writing and the words "notify", "certify or "determine" shall be construed accordingly. Any such consent, approval, certificate or determination shall not unreasonably be withheld or delayed.

Engineer and Engineer's Representative

2.1 Engineer's Duties and Authority

- (a) The Engineer shall carry out the duties specified in the Contract.
- (b) The Engineer may exercise the authority specified in or necessarily to be implied from the Contract, provided, however, that if the Engineer is required, under the terms of his appointment by the Employer, to obtain the specific approval of the Employer before exercising any such authority, particulars of such requirements shall be set out in Part II of these Conditions. Provided further that any requisite approval shall be deemed to have been given by the Employer for any such authority exercised by the Engineer.
- (c) Except as expressly stated in the Contract, the Engineer shall have no authority to relieve the Contractor of any of his obligations under the Contract.

2.2 Engineer's Representative

The Engineer's Representative shall be appointed by and be responsible to the Engineer and shall carry out such duties and exercise such authority as may be delegated to him by the Engineer under Sub-Clause 2.3.

2.3 Engineer's Authority to Delegate

The Engineer may from time to time delegate to the Engineer's Representative any of the duties and authorities vested in the Engineer and he may at any time revoke such delegation. Any such delegation or revocation shall be in writing and shall not take effect until a copy thereof has been delivered to the Employer and the Contractor.

Any communication given by the Engineer's Representative to the Contractor in accordance with such delegation shall have the same effect as though it had been given by the Engineer. Provided that:



- (a) any failure of the Engineer's Representative to disapprove any work, materials or Plant shall not prejudice the authority of the Engineer to disapprove such work, materials or Plant and to give instructions for the rectification thereof; and
- (b) if the Contractor questions any communication of the Engineer's Representative he may refer the matter to the Engineer who shall confirm, reverse or vary the contents of such communication.

2.4 Appointment of Assistants

The Engineer or the Engineer's Representative may appoint any number of persons to assist the Engineer's Representative in the carrying out of his duties under Sub-Clause 2.2. He shall notify to the Contractor the names, duties and scope of authority of such persons. Such assistants shall have no authority to issue any instructions to the Contractor save in so far as such instructions may be necessary to enable them to carry out their duties and to secure their acceptance of materials, Plant or workmanship as being in accordance with the Contract, and any instructions given by any of them for those purposes shall be deemed to have been given by the Engineer's Representative.

2.5 Instructions in Writing

Instructions given by the Engineer shall be in writing, provided that if for any reason the Engineer considers it necessary to give any such instruction orally, the Contractor shall comply with such instruction. Confirmation in writing of such oral instruction given by the Engineer, whether before or after the carrying out of the instruction, shall be deemed to be an instruction within the meaning of this Sub-Clause. Provided further that if the Contractor, within 7 days, confirms in writing to the Engineer any oral instruction of the Engineer and such confirmation is not contradicted in writing within 7 days by the Engineer, it shall be deemed to be an instructions of the Engineer.

The provisions of this Sub-Clause shall equally apply to instructions given by the Engineer's Representative and any assistants of the Engineer or the Engineer's Representative appointed pursuant to Sub-Clause 2.4.

2.6 Engineer to Act Impartially

Wherever, under the Contract, the Engineer is required to exercise his discretion by:

- (a) giving his decision, opinion or consent,
- (b) expressing his satisfaction or approval,
- (c) determining value, or
- (d) otherwise taking action which may affect the rights and obligations of the Employer or the Contractor

he shall exercise such discretion impartially and fairly within the terms of the Contract and having regard to all the circumstances. Any such decision, opinion, consent expression of satisfaction, or approval, determination of value or action may be opened up, reviewed or revised as provided in Clause 67.



Assignment and Subcontracting

3.1 Assignment of Contract

The Contractor shall not, without the prior written consent of the Employer (which consent, notwithstanding the provisions of Sub-Clause 1.5, shall be at the sole discretion of the Employer), assign the Contract or any part thereof, or any benefit or interest therein or thereunder, otherwise than by:

- (a) a charge in favour of the Contractor's bankers of any monies due or to become due under the Contract, or
- (b) assignment to the Contractor's insurers (in cases where the insurers have discharged the Contractor's loss or liability) of the Contractor's right to obtain relief against any other party liable.

4.1 Subcontracting

The Contractor shall not subcontract the whole of the Works. Except where otherwise provided by the Contract, the Contractor shall not subcontract any part of the Works without the prior consent of the Engineer. Any such consent shall not relieve the Contractor from any liability or obligation under the Contract and he shall be responsible for the acts, defaults and neglects of any Subcontractor, his agents, servants or workmen as fully as if they were the acts, defaults or neglects of the Contractor, his agent's servants or workmen.

Provided that the Contractor shall not be required to obtain such consent for:

- (a) the provision of Labour,
- (b) the purchase of materials which are in accordance with the standards specified in the Contract,
- (c) the subcontracting of any part of the Works for which the Subcontractor is named in the Contract.

4.2 Assignment of Subcontractors' Obligations

In the event of a Subcontractor having undertaken towards the Contractor in respect of the work executed, or the goods, materials, Plant or services supplied by such Subcontractor, any continuing obligation extending for a period exceeding that of the Defects Liability Period under the Contract, the Contractor shall at any time, after the expiration of such Period, assign to the Employer, at the Employer's request and cost, the benefit of such obligation for the unexpired duration thereof.



Contract Documents

5.1 Language/s and Law

There is stated in Part II of these Conditions:

- (a) the language or languages in which the Contract documents shall be drawn up, and
- (b) the country or state the law of which shall apply to the Contract and according to which the Contract shall be construed.

If the said documents are written in more than one language, the language according to which the Contract shall be construed and interpreted is also stated in Part II of these Conditions, being therein designated the "Ruling Language".

5.2 Priority of Contract Documents

The several documents forming the Contract are to be taken as mutually explanatory of one another, but in case of ambiguities or discrepancies the same shall be explained and adjusted by the Engineer who shall thereupon issue to the Contractor instructions thereon and in such event, unless otherwise provided in the Contract, the priority of the documents forming the Contract shall be as follows:

- (1) The Contract (if completed);
- (2) The Letter of Acceptance;
- (3) The Tender;
- (4) Part II of these Conditions;
- (5) Part I of these Conditions; and
- (6) Any other document forming part of the Contract.

6.1 Custody and Supply of Drawings and Documents

The Drawings shall remain in the sole custody of the Engineer, but two copies thereof shall be provided to the Contractor free of charge. The Contractor shall make at his own cost any further copies required by him. Unless it is strictly necessary for the purposes of the Contract, the Drawings, Specification and other documents provided by the Employer or the Engineer shall not, without the consent of the Engineer, be used or communicated to a third party by the Contractor. Upon issue of the Defects Liability Certificate, the Contractor shall return to the Engineer all Drawings, Specification and other documents provided under the Contract.

The Contractor shall supply to the Engineer four copies of all Drawings, specification and other documents submitted by the Contractor and approved by the Engineer in accordance with Clause 7, together with a reproducible copy of any material which cannot be reproduced to an equal standard by photocopying. In addition the Contractor shall supply such further copies of such Drawings, Specification and other



documents as the Engineer may request in writing for the use of the Employer, who shall pay the cost thereof.

6.2 One Copy of Drawings to be kept on Site

One copy of the Drawings, provided to or supplied by the Contractor as aforesaid, shall be kept by the Contractor on the Site and the same shall at all reasonable times be available for inspection and use by the Engineer and by any other person authorized by the Engineer in writing.

6.3 Disruption of Progress

The Contractor shall give notice to the Engineer, with a copy to the Employer, whenever planning or execution of the Works is likely to be delayed or disrupted unless any further drawing or instruction is issued by the Engineer within a reasonable time. The notice shall include details of the drawing or instruction required and of why and by when it is required and of any delay or disruption likely to be suffered if it is late.

6.4 Delay and Cost of Delay of Drawings

If, by reason of any failure or inability of the Engineer to issue, within a time reasonable in all the circumstances, any drawing or instruction for which notice has been given by the Contractor in accordance with Sub-Clause 6.3, the Contractor suffers delay and/or incurs costs then the Engineer shall, after due consultation with the Employer and the Contractor, determine:

- (a) any extension of time to which the Contractor is entitled under Clause 44, and
- (b) the amount of such costs, which shall be added to the Contract Price, and shall notify the Contractor accordingly, with a copy to the Employer.

6.5 Failure by Contractor to Submit Drawings

If the failure or inability of the Engineer to issue any drawings or instructions is caused in whole or in part by the failure of the Contractor to submit Drawings, Specification or other documents which he is required to submit under the Contract, the Engineer shall take such failure by the Contractor into account when making his determination pursuant to Sub-Clause 6.4.

7.1 Supplementary Drawings and Instructions

The Engineer shall have authority to issue to the Contractor, from time to time, such supplementary Drawings and instructions as shall be necessary for the purpose of the proper and adequate execution and completion of the Works and the remedying of any defects therein. The Contractor shall carry out and be bound by the same.



7.2 Permanent Works Designed by Contractor

Where the Contract expressly provides that part of the Permanent Works shall be designed by the Contractor, he shall submit to the Engineer, for approval:

- (a) such drawings, specifications, calculations and other information as shall be necessary to satisfy the Engineer as to the suitability and adequacy of that design, and
- (b) operation and maintenance manuals together with drawings of the Permanent Works as completed, in sufficient detail to enable the Employer to operate, maintain, dismantle, reassemble and adjust the Permanent Works incorporating that design. The Works shall not be considered to be completed for the purposes of taking over in accordance with Clause 48 until such operation and maintenance manuals together with drawings on completion have been submitted to and approved by the Engineer.

7.3 Responsibility Unaffected by Approval

Approval by the Engineer, in accordance with Sub-Clause 7.2, shall not relieve the Contractor of any of his responsibilities under the Contract.

General Obligations

8.1 Contractor's General Responsibilities

The Contractor shall always act and perform, with due care and diligence, design (to the extent provided for by the Contract), execute and complete the Works and remedy any defects therein in accordance with the provisions of the Contract. The Contractor shall provide all super-intendance, labour, material, Plant, Contractor's Equipment and all other things, whether of a temporary or permanent nature, required in and for such design, execution, completion and remedying of any defects, so far as the necessity for providing the same is specified in or is reasonably to be inferred from the Contract.

8.2 Site Operations and Methods of Construction

The Contractor shall take full responsibility for the adequacy, stability and safety of all Site operations and methods of construction. Provided that the Contractor shall not be responsible (except as stated hereunder or as may be otherwise agreed) for the design or specification of Permanent Works, or for the design or specification of any Temporary Works not prepared by the Contractor. Where the Contract expressly provides that part of the Permanent Works shall be designed by the Contractor, he shall be fully responsible for that part of such Works, notwithstanding any approval by the Engineer.



9.1 **Contract**

The Contractor shall, if called upon so to do, enter into and execute the Contract Agreement, to be prepared and completed at the cost of the Employer, in the form annexed to these Conditions with such modification as may be necessary.

10.1 **Performance Guarantee**

If the Contract requires the Contractor to obtain Performance Guarantee in the shape of Bank Guarantee for his proper performance of the Contract, he shall obtain and provide to the Employer, such guarantee within 14 days after the receipt of the Letter of Acceptance, in the sum stated in the Appendix to Tender. Such guarantee shall be in the form annexed to these Conditions or on the Employer Format. The institution providing such security shall be subject to the approval of the Employer. The cost of complying with the requirements of this Clause shall be borne by the Contractor, unless the Contract otherwise provides.

10.2 **Period of Validity of Performance Guarantee**

The performance guarantee shall be valid until the Contractor has executed and completed the Works and remedied any defects therein in accordance with the Contract. Such guarantee shall be returned to the Contractor after 14 days of the issuance of Final Completion Certificate by the Employer.

10.3 **Claims under Performance Guarantee**

Prior to making a claim under the performance guarantee the Employer shall in every case, notify the Contractor stating the nature of the default in respect of which the claim is to be made.

11.1 **Inspection of Site**

The Employer shall have made available to the Contractor, before the submission by the Contractor of the Tender, such data on hydrological and sub-surface conditions as have been obtained by or on behalf of the Employer from investigations undertaken relevant to the Works but the Contractor shall be responsible for his own interpretation thereof.

The Contractor shall be deemed to have inspected and examined the Site and its surroundings and information available in connection therewith and to have satisfied himself (so far as is practicable, having regard to considerations of cost and time) before submitting his Tender, as to:

- (a) the form and nature thereof, including the sub-surface conditions,
- (b) the hydrological and climatic conditions,
- (c) the extent and nature of work and materials necessary for the execution and



completion of the Works and the remedying of any defects therein, and

- (d) the means of access to the Site and the accommodation he may require, and, in general, shall be deemed to have obtained all necessary information, subject as above mentioned, as to risks, contingencies and all other circumstances which may influence or affect his Tender.

The Contractor shall be deemed to have based his Tender on the data made available by the Employer and on his own inspection and examination, all as aforementioned.

12.1 Sufficiency of Tender

The Contractor shall be deemed to have satisfied himself as to the correctness and sufficiency of the Tender and of the rates and prices stated in the Bill of Quantities, all of which shall, except insofar as it is otherwise provided in the Contract, cover all his obligations under the Contract (including those in respect of the supply of goods, materials, Plant or services or of contingencies for which there is a Provisional Sum) and all matters and things necessary for the proper execution and completion of the Works and the remedying of any defects therein.

12.2 Not Foreseeable Physical Obstructions or Conditions

If, however, during the execution of the Works the Contractor encounters physical obstructions or physical conditions, other than climatic conditions on the Site, which obstructions or conditions were, in his opinion, not foreseeable by an experienced contractor, the Contractor shall forthwith give notice thereof to the Engineer, with a copy to the Employer. On receipt of such notice, the Engineer shall if in his opinion such obstructions or conditions could not have been reasonably foreseen by an experienced contractor, after due consultation with the Employer and the Contractor, determine:

- (a) any extension of time to which the Contractor is entitled under Clause 44, and
- (b) the amount of any costs which may have been incurred by the Contractor by reason of such obstructions or conditions having been encountered, which shall be added to the Contract Price,

and shall notify the Contractor accordingly, with a copy to the Employer. Such determination shall take account of any instruction which the Engineer may issue to the Contractor in connection therewith, and any proper and reasonable measures acceptable to the Engineer which the Contractor may take in the absence of specific instructions from the Engineer.

13.1 Work to be in Accordance with Contract

Unless it is legally or physically impossible, the Contractor shall execute and complete the Works and remedy any defects therein in strict accordance with the Contract to the satisfaction of the Engineer. The Contractor shall comply with and adhere strictly to the Engineer's instructions on any matter, whether mentioned in the



Contract or not, touching or concerning the Works. The Contractor shall take instructions only from the Engineer (or his delegate).

14.1 Programme to be Submitted

The Contractor shall, within the time stated in Part II of these Conditions after the date of the Letter of Acceptance, submit to the Engineer for his consent a programme, in such form and detail as the Engineer shall reasonably prescribe, for the execution of the Works. The Contractor shall, whenever required by the Engineer, also provide in writing for his information a general description of the arrangements and methods which the Contractor proposes to adopt for the execution of the Works.

14.2 Revised Programme

If at any time it should appear to the Engineer that the actual progress of the Works does not conform to the programme to which consent has been given under Sub-Clause 14.1, the Contractor shall produce, at the request of the Engineer, a revised programme showing the modifications to such programme necessary to ensure completion of the Works within the Time for Completion.

14.3 Cash Flow Estimate to be submitted

The Contractor shall, within the time stated in Part II of these Conditions after the date of the Letter of Acceptance, provide to the Engineer for his information a detailed cash flow estimate, in quarterly periods, of all payments to which the Contractor will be entitled under the Contract and the Contractor shall subsequently supply revised cash flow estimates at quarterly intervals, if required to do so by the Engineer.

14.4 Contractor not Relieved of Duties or Responsibilities

The submission to and consent by the Engineer of such programme or the provision of such general descriptions or cash flow estimates shall not relieve the Contractor of any of his duties or responsibilities under the Contract.

15.1 Contractor's Superintendence

The Contractor shall provide all necessary superintendence during the execution of the Works and as long thereafter as the Engineer may consider necessary for the proper fulfilling of the Contractor's obligations under the Contract. The Contractor, or a competent and authorized representative approved of by the Engineer, which approval may at any time be withdrawn, shall give his whole time to the superintendence of the Works. Such authorized representative shall receive, on behalf of the Contractor, instructions from the Engineer.

If approval of the representative is withdrawn by the Engineer, the Contractor shall, as soon as is practicable, having regard to the requirement of replacing him as hereinafter mentioned, after receiving notice of such withdrawal, remove the representative from the Works and shall not thereafter employ him again on the



Works in any capacity and shall replace him by another representative approved by the Engineer.

16.1 Contractor's Employees

The Contractor shall provide on the Site in connection with the execution and completion of the Works and the remedying of any defects therein:

- (a) only such technical assistants as are skilled and experienced in their respective callings and such foremen and leading hands as are competent to give proper superintendence of the Works, and
- (b) such skilled, semi skilled and unskilled labour as is necessary for the proper and timely fulfilling of the Contractor's obligations under the Contract.

16.2 Engineers at Liberty to Object

The Engineer shall be at liberty to object to and require the Contractor to remove forthwith from the Works any person provided by the Contractor who, in the opinion of the Engineer, misconducts himself, or is incompetent or negligent in the proper performance of his duties, or whose presence on Site is otherwise considered by the Engineer to be undesirable or security risk, and such person shall not be again allowed upon the Works without the consent of the Engineer. Any person so removed from the Works shall be replaced as soon as possible.

17.1 Setting-out

The Contractor shall be responsible for:

- (a) the accurate setting-out of the Works in relation to original points, lines and levels of reference given by the Engineer in writing,
- (b) the correctness, subject as above mentioned of the position, levels dimensions and alignment of all parts of the Works, and
- (c) the provision of all necessary instruments, appliances and labour in connection with the foregoing responsibilities.

If, at any time during the execution of the Works, any error appears in the position, levels, dimensions or alignment of any part of the Works, the Contractor, on being required so to do by the Engineer, shall, at his own cost, rectify such error to the satisfaction of the Engineer, unless such error is based on incorrect data supplied in writing by the Engineer, in which case the Engineer shall determine an addition to the Contract Price in accordance with Clause 52 and shall notify the Contractor accordingly, with a copy to the Employer.

The checking of any setting-out or of any line or level by the Engineer shall not in any way relieve the Contractor of his responsibility for the accuracy thereof and the Contractor shall carefully protect and preserve all bench-marks, sight-rails, pegs and



other things used in setting-out the Works.

18.1 **Boreholes and Exploratory Excavation**

If, at any time during the execution of the Works, the Engineer requires the Contractor to make boreholes or to carry out exploratory excavation, such requirement shall be the subject of an instruction in accordance with Clause 51, unless an item or a Provisional Sum in respect of such work is included in the Bill of Quantities.

19.1 **Safety, Security and Protection of the Environment**

The Contractor shall, throughout the execution and completion of the Works and the remedying of any defects therein:

- (a) have full regard for the safety of all persons entitled to be upon the Site and keep the Site (so far as the same is under his control) and the Works (so far as the same are not completed or occupied by the Employer) in an orderly state appropriate to the avoidance of danger to such persons,
- (b) provide and maintain at his own cost all lights, guards, fencing, warning signs and watching, when and where necessary or required by the Engineer or by any duly constituted authority, for the protection of the Works or for the safety and convenience of the public or others, and
- (c) take all reasonable steps to protect the environment on and off the Site and to avoid damage or nuisance to persons or to property of the public or others resulting from pollution, noise or other causes arising as a consequence of his methods of operation.

19.2 **Employer's Responsibilities**

If under Clause 31 the Employer shall carry out work on the Site with his own workmen he shall, in respect of such work:

- (a) have full regard to the safety of all persons entitled to be upon the Site, and
- (b) keep the Site in an orderly state appropriate to the avoidance of danger to such persons.

If under Clause 31 the Employer shall employ other contractors on the Site he shall require them to have the same regard for safety and avoidance of danger.

20.1 **Care of Works**

The Contractor shall take full responsibility for the care of the Works and materials and Plant for incorporation therein from the Commencement Date until the date of issue of the Taking-Over Certificate for the whole of the Works, when the



responsibility for the said care shall pass to the Employer. Provided that:

- (a) if the Engineer issues a Taking-Over Certificate for any Section or part of the Permanent Works the Contractor shall cease to be liable for the care of that Section or part from the date of issue of the Taking-Over Certificate, when the responsibility for the care of that Section or part shall pass to the Employer, and
- (b) the Contractor shall take full responsibility for the care of any outstanding Works and materials and Plant for incorporation therein which he undertakes to finish during the Defects Liability Period until such outstanding Works have been completed pursuant to Clause 49.

20.2 Responsibility to Rectify Loss or Damage

If any loss or damage happens to the Works, or any part thereof, or materials or Plant for incorporation therein, during the period for which the Contractor is responsible for the care thereof, from any cause whatsoever, other than the risks defined in Sub-Clause 20.4, the Contractor shall, at his own cost, rectify such loss or damage so that the Permanent Works conform in every respect with the provisions of the Contract to the satisfaction of the Engineer. The Contractor shall also be liable for any loss or damage to the Works occasioned by him in the course of any operations carried out by him for the purpose of complying with his obligations under Clauses 49 and 50.

20.3 Loss or Damage Due to Employer's Risks

In the event of any such loss or damage happening from any of the risks defined in Sub-Clause 20.4, or in combination with other risks, the Contractor shall, if and to the extent required by the Engineer, rectify the loss or damage and the Engineer shall determine an addition to the Contract Price in accordance with Clause 52 and shall notify the Contractor accordingly, with a copy to the Employer. In the case of a combination or risks causing loss or damage any such determination shall take into account the proportional responsibility of the Contractor and the Employer.

20.4 Employer's Risks

The Employer's risks are:

- (a) war, hostilities (whether war be declared or not), invasion, act of foreign enemies,
- (b) Rebellion, revolution, insurrection, or military or usurped power, or civil war,
- (c) ionising radiations, or contamination by radio-activity from any nuclear fuel, or from any nuclear waste from the combustion of nuclear fuel, radio-active toxic explosive, or other hazardous properties of any explosive nuclear assembly or nuclear component thereof,



- (d) pressure waves caused by aircraft or other aerial devices travelling at sonic or supersonic speeds,
- (e) riot, commotion or disorder, unless solely restricted to employees of the Contractor or of his Subcontractor and arising from the conduct of the Works,
- (f) loss or damage due to the use or occupation by the Employer of any Section or part of the Permanent Works, except as may be provided for in the Contract,
- (g) loss or damage to the extent that it is due to the design of the Works, other than any part of the design provided by the Contractor or for which the Contractor is responsible, and
- (h) any operation of the forces of nature against which an experienced contractor could not reasonably have been expected to take precautions.

21.1 Insurance of Works and Contractor's Equipment

The Contractor shall, without limiting his or the Employer's obligations and responsibilities under Clause 20, insure:

- (a) the Works, together with materials and Plant for incorporation therein, to the full replacement cost (the term "cost" in this context shall include profit),
- (b) an additional sum of 15 per cent of such replacement cost, or as may be specified in Part II of these Conditions, to cover any additional costs of and incidental to the rectification of loss or damage including professional fees and the cost of demolishing and removing any part of the Works and of removing debris of whatsoever nature, and
- (c) the Contractor's Equipment and other things brought onto the Site by the Contractor, for a sum sufficient to provide for their replacement at the Site.

21.2 Scope of Cover

The insurance in paragraphs (a) and (b) of Sub-Clause 21.1 shall be in the joint names of the Contractor and the Employer and shall cover:

- (a) the Employer and the Contractor against all loss or damage from whatsoever cause arising, other than as provided in Sub-Clause 21.4, from the start of work at the Site until the date of issue of the relevant Taking-Over Certificate in respect of the Works or any Section or part thereof as the case may be, and
- (b) the Contractor for his liability:
 - (i) during the Defects Liability Period for loss or damage arising from a cause occurring prior to the commencement of the Defects Liability Periods, and



- (ii) for loss or damage occasioned by the Contractor in the course of any operations carried out by him for the purpose of complying with his obligations under Clauses 49 and 50.

21.3 Responsibility for Amounts not recovered

Any amounts not insured or not recovered from the insurers shall be borne by the Employer or the Contractor in accordance with their responsibilities under Clause 20.

21.4 Exclusions

There shall be no obligation for the insurances in Sub-Clause 21.1 to include loss or damage caused by:

- (a) war, hostilities (where war be declared or not), invasion, act of foreign enemies,
- (b) rebellion, revolution, insurrection, or military or usurped power, or civil war,
- (c) ionising, radiations, or contamination by radio-activity from any nuclear fuel, or from any nuclear waste from the combustion of nuclear fuel, radio-active toxic explosive or other hazardous properties of any explosive nuclear assembly or nuclear component thereof, or
- (d) pressure waves caused by aircraft or other aerial devices travelling at sonic or supersonic speeds.

22.1 Damage to Persons and Property

The Contractor shall, except if and so far as the Contract provides otherwise, indemnify the Employer against all losses and claims in respect of:

- (a) death of or injury to any person, or
- (b) loss of or damage to any property (other than the Works),

which may arise out of or in consequence of the execution and completion of the Works and the remedying of any defects therein, and against all claims, proceedings, damages, costs, charges and expenses whatsoever in respect thereof or in relation thereto, subject to the exceptions defined in Sub-Clause 22.2.

22.2 Exceptions

The "exceptions" referred to in Sub-Clause 22.1 are:

- (a) the permanent use or occupation of land by the Works, or any part thereof,
- (b) the right of the Employer to execute the Works, or any part thereof, on, over, under, is or through any land,



- (c) damage to property which is the unavoidable result of the execution and completion of the Works, or the remedying of any defects therein, in accordance with the Contract, and
- (d) death of or injury to persons or loss of or damage to property resulting from any act or neglect of the Employer, his agents servants or other contractors, not being employed by the Contractor, or in respect of any claims, proceedings, damages, costs, charges and expenses in respect thereof or in relation thereto or, where the injury or damage was contributed to by the Contractor, his servants or agents, such part of the said injury or damage as may be just and equitable having regard to the extent of the responsibility of the Employer, his servants or agents or other contractors for the injury or damage.

22.3 Indemnity by Employer

The Employer shall indemnify the Contractor against all claims, proceedings, damages, costs, charges and expenses in respect of the matters referred to in the exceptions defined in Sub-Clause 22.2

23.1 Third Party Insurance (including Employer's Property)

The Contractor shall, without limiting his or the Employer's obligation and responsibilities under Clause 22, insure, in the joint names of the Contractor and the Employer, against liabilities for death of or injury to any person (other than as provided in Clause 24) or loss of or damage to any property (other than the Works) arising out of the performance of the Contract, other than the exceptions defined in paragraphs (a), (b) and (c) of Sub-Clause 22.2.

23.2 Minimum Amount of Insurance

Such insurance shall be for at least the amount stated in the Appendix to Tender.

23.3 Cross Liabilities

The insurance policy shall include a cross liability clause such that the insurance shall apply to the Contractor and to the Employer as separate insured's.

24.1 Accident or Injury to Workmen

The Employer shall not be liable for or in respect of any damages or compensation payable to any workman or other person in the employment of the Contractor or any Subcontractor, other than death or injury resulting from any act or default of the Employer, his agents or servants. The Contractor shall indemnify and keep indemnified the Employer against all such damages and compensation, other than those for which the Employer is liable as aforesaid, and against all claims, proceedings, damages, costs, charges, and expenses whatsoever in respect thereof or in relation thereto.



24.2 Insurance Against Accidents, etc. to Workmen

The Contractor shall insure against such liability and shall continue such insurance during the whole of the time that any persons are employed by him on the Works. Provided that, in respect of any persons employed by any Subcontractor, the Contractor's obligations to insure as aforesaid under the Sub-Clause shall be satisfied if the Subcontractor shall have insured against the liability in respect of such persons in such manner that the Employer is indemnified under the policy, but the Contractor shall require such Subcontractor to produce to the Employer, when required, such policy of insurance and the receipt for the payment of the current premium.

25.1 Evidence and Terms of Insurances

The Contractor shall provide evidence to the Employer prior to the start of work at the Site that the insurances required under the Contract have been effected and shall, within 84 days of the Commencement Date, provide the insurance policies to the Employer. When providing such evidence and such policies to the Employer, the Contractor shall notify the Engineer of so doing. Such insurance policies shall be consistent with the general terms agreed prior to the issue of the Letter of Acceptance. The Contractor shall effect all insurances for which he is responsible with insurers

25.2 Adequacy of Insurances

The Contractor shall notify the insurers of changes in the nature, extent or programme for the execution of the Works and ensure the adequacy of the insurances at all times in accordance with the terms of the Contract and shall, when required, produce to the Employer the insurance policies in force and the receipts for payment of the current premiums.

25.3 Remedy on Contractor's Failure to Insure

If the Contractor fails to effect and keep in force any of the insurances required under the Contract, or fails to provide the policies to the Employer within the period required by Sub-Clause 25.1, then and in any such case the Employer may effect and keep in force any such insurances and pay any premium as may be necessary for that purpose and from time to time deduct the amount so paid from any monies due or to become due to the Contractor, or recover the same as a debt due from the Contractor.

25.4 Compliance with Policy Conditions

In the event that the Contractor or the Employer fails to comply with conditions imposed by the insurance policies effected pursuant to the Contract, each shall indemnify the other against all losses and claims arising from such failure.



26.1 Compliance with Statutes, Regulations

The Contractor shall conform in all respects, including by the giving of all notices and the paying of all fees, with the provisions of:

- (a) any National or State Statute, Ordinance, or other Law, or any regulation, or by-law of any local or other duly constituted authority in relation to the execution and completion of the Works and the remedying of any defects therein, and
- (b) the rules and regulations of all public bodies and companies whose property or rights are affected or may be affected in any way by the Works,

and the Contractor shall keep the Employer indemnified against all penalties and liability of every kind for breach of any such provisions. Provided always that the Employer shall be responsible for obtaining any planning, zoning or other similar permission required for the Works to proceed and shall indemnify the Contractor in accordance with Sub-Clause 22.3.

27.1 Fossils, etc.

All fossils, coins, articles of value or antiquity and structures and other remains or things of geological or archaeological interest discovered on the Site shall, as between the Employer and the Contractor, be deemed to be the absolute property of the Employer. The Contractor shall take reasonable precautions to prevent his workmen or any other persons from removing or damaging any such article or thing and shall, immediately upon discovery thereof and before removal, acquaint the Engineer of such discovery and carry out the Engineer's instructions for dealing with the same. If, by reason of such instructions, the Contractor suffers delay and/or incurs costs then the Engineer shall, after due consultation with the Employer and the Contractor, determine:

- (a) any extension of time to which the Contractor is entitled under Clause 44, and
- (b) the amount of such costs, which shall be added to the Contract Price, and shall notify the Contractor accordingly, with a copy to the Employer.

28.1 Patent Rights

The Contractor shall save harmless and indemnify the Employer from and against all claims and proceedings for or on account of infringement of any patent rights, design trademark or name or other protected rights in respect of any Contractor's Equipment, materials or Plant used for or in connection with or for incorporation in the Works and from and against all damages, costs, charges and expenses whatsoever in respect thereof or in relation thereto, except where such infringement results from compliance with the design or Specification provided by the Engineer.



28.2 Royalties

Except where otherwise stated, the Contractor shall pay all tonnage and other royalties, rent and other payments or compensation, if any, for getting stone, sand, gravel, clay or other materials required for the Works.

29.1 Interference with Traffic and Adjoining Properties

All operations necessary for the execution and completion of the Works and the remedying of any defects therein shall, so far as compliance with the requirements of the Contract permits, be carried on so as not to interfere unnecessarily or improperly with:

- (a) the convenience of the public, or
- (b) the access to, use and occupation of public or private roads and footpaths to or of properties whether in the possession of the Employer or of any other person.

The Contractor shall save harmless and indemnify the Employer in respect of all claims, proceedings, damages, costs, charges and expenses whatsoever arising out of, or in relation to, any such matters insofar as the Contractor is responsible therefore.

30.1 Avoidance of Damage to Roads

The Contractor shall use and adopt every reasonable means and measures to prevent private and public property or any of the roads or bridges communicating with or on the routes to the Site from being damaged or injured by any traffic of the Contractor or any of his Subcontractors and, in particular, shall select routes, choose and use vehicles and restrict and distribute loads so that any such extraordinary traffic as will inevitably arise from the moving of materials, Plant, Contractor's Equipment or Temporary Works from and to the Site shall be limited, as far as reasonably possible, and so that no unnecessary damage or injury may be occasioned to such roads and bridges.

30.2 Transport of Contractor's Equipment or Temporary Works

Save insofar as the Contract otherwise provides, the Contractor shall be responsible for and shall pay the cost of strengthening any bridges or altering or improving any road communicating with or on the routes to the Site to facilitate the movement of Contractor's Equipment or Temporary Works and the Contractor shall indemnify and keep indemnified the Employer against all claims for damage to any such road or bridge caused by such movement, including such claims as may be made directly against the Employer, and shall negotiate and pay all claims arising solely out of such damage.

30.3 Transport of Materials or Plant

If, notwithstanding Sub-Clause 30.1, any damage occurs to any bridge or road communicating with or on the routes to the Site arising from the transport of materials



or Plant, the Contractor shall notify the Engineer with a copy to the Employer, as soon as he becomes aware of such damage or as soon as he receives any claim from the authority entitled to make such claim. Where under any law or regulation the hauler of such materials or Plant is required to indemnify the road authority against damage the Employer shall not be liable for any costs, charges or expenses in respect thereof or in relation thereto. In other cases the Employer shall negotiate the settlement of and pay all sums due in respect of such claim and shall indemnify the Contractor in respect thereof and in respect of all claims, proceedings damages, costs, charges and expenses in relation thereto. Provided that if and so far as any such claim or part thereof is, in the opinion of the Engineer, due to any failure on the part of the Contractor to observe and perform his obligations under Sub-Clause 30.1, then the amount determined by the Engineer, after due consultation with the Employer and the Contractor, to be due to such failure shall be recoverable from the Contractor by the Employer and may be deducted by the Employer from any monies due or to become due to the Contractor and the Engineer shall notify the Contractor accordingly, with a copy to the Employer. Provided also that the Employer shall notify the Contractor whenever a settlement is to be negotiated and, where any amount may be due from the Contractor, the Employer shall consult with the Contractor before such settlement is agreed.

30.4 Waterborne Traffic

Where the nature of the Works is such as to require the use by the Contractor of waterborne transport the foregoing provisions of this Clause shall be construed as though "road" included a lock, dock, sea wall or other structure related to a waterway and "vehicle" included craft, and shall have effect accordingly.

31.1 Opportunities for Other Contractors

The Contractor shall, in accordance with the requirements of the Engineer, afford all reasonable opportunities for carrying out their work to:

- (a) any other contractors employed by the Employer and their workmen,
- (b) the workmen of the Employer, and
- (c) the workmen of any duly constituted authorities who may be employed in the execution on or near the Site of any work not included in the Contract or of any contract which the Employer may enter into in connection with or ancillary to the Works.

31.2 Facilities for Other Contractors

If, however, pursuant to Sub-Clause 31.1 the Contractor shall, on the written request of the Engineer:

- (a) make available to any other contractor, or to the Employer or any such authority, any roads or ways for the maintenance of which the Contractor is responsible,



(b) permit the use, by any such, of Temporary Works or Contractor's Equipment on the Site, or

(c) provide any other service of whatsoever nature for any such,

the Engineer shall determine an addition to the Contract Price in accordance with Clause 52 and shall notify the Contractor accordingly, with a copy to the Employer.

32.1 **Contractor to Keep Site Clear**

During the execution of the Works the Contractor shall keep the Site reasonably free from all unnecessary obstruction and shall store or dispose of any Contractor's Equipment and surplus materials and clear away and remove from the Site any wreckage, rubbish or Temporary Works no longer required.

33.1 **Clearance of Site on Completion**

Upon the issue of any Taking-Over Certificate the Contractor shall clear away and remove from that part of the Site to which such Taking-Over Certificate relates all Contractor's Equipment, surplus materials, rubbish and Temporary Works of every kind, and leave such part of the Site and Works clean and in a workmanlike condition to the satisfaction of the Engineer. Provided that the Contractor shall be entitled to retain on Site, until the end of the Defects Liability Period, such materials, Contractor's Equipment and Temporary Works as are required by him for the purpose of fulfilling his obligations during the Defects Liability Period.

Labour

34.1 **Engagement of Staffs and Labour**

The Contractor shall, unless otherwise provided in the Contract, make his own arrangements for the engagement of all staff and labour, local or other, and for their payment, housing, feeding and transport.

35.1 **Returns of Labour and Contractor's Equipment**

The Contractor shall, if required by the Engineer, deliver to the Engineer a return in detail, in such form and at such intervals as the Engineer may prescribe, showing the staff and the numbers of the several classes of labour from time to time employed by the Contractor on the Site and such information respecting Contractor's Equipment as the Engineer may require.

Materials, Plant and Workmanship

36.1 **Quality of Materials, Plant and Workmanship**

All materials, Plant and workmanship shall be:

(a) of the respective kinds described in the Contract and in accordance with the



Engineer's instructions, and

(b) subjected from time to time to such tests as the Engineer may require at the place of manufacture, fabrication or preparation, or on the Site or at such other place or places as may be specified in the Contract, or at all or any of such places.

The Contractor shall provide such assistance, labour, electricity, fuels, stores, apparatus and instruments as are normally required for examining, measuring and testing any materials or Plant and shall supply samples of materials, before incorporation in the Works, for testing as may be selected and required by the Engineer.

36.2 Cost of Samples

All samples shall be supplied by the Contractor at his own cost if the supply thereof is clearly intended by or provided for in the Contract.

36.3 Cost of Tests

The cost of making any test shall be borne by the Contractor if such test

is: (a) clearly intended by or provided for in the Contract, or

(b) particularised in the Contract (in cases only for a test under load or of a test to ascertain whether the design of any finished or partially finished work is appropriate for the purposes which it was intended to fulfill) in sufficient detail to enable the Contractor to price or allow for the same in his Tender.

36.4 Cost of Tests not Provided for

If any test required by the Engineer which

is: (a) not intended by or provided for,

(b) (in the cases above mentioned) not so particularized, or

(c) (through so intended or provided for) required by the Engineer to be carried out at any place other than the Site or the place of manufacture, fabrication or preparation of the materials or Plant tested,

shows the materials, Plant or workmanship not to be in accordance with the provisions of the Contract to the satisfaction of the Engineer, then the cost of such test shall be borne by the Contractor, but in any other case Sub-Clause 36.5 shall apply.

36.5 Engineer's Determination where Tests not provided for

Where, pursuant to Sub-Clause 36.4, this Sub-Clause applies the Engineer shall, after due consultation with the Employer and the Contractor, determine:



(a) any extension of time of which the Contractor is entitled under Clause 44, and

(b) the amount of such costs, which shall be added to the Contract Price,

and shall notify the Contractor accordingly, with a copy to the Employer.

37.1 Inspection of Operations

The Engineer, and any person authorized by him, shall at all reasonable times have access to the Site and to all workshops and places where materials or Plant are being manufactured, fabricated or prepared for the Works and the Contractor shall afford every facility for and every assistance in obtaining the right to such access.

37.2 Inspection and Testing

The Engineer shall be entitled, during manufacture, fabrication or preparation to inspect and test the materials and Plant to be supplied under the Contract. If materials or Plant are being manufactured, fabricated or prepared in workshops or places other than those of the Contractor, the Contractor shall obtain permission for the Engineer to carry out such inspection and testing in those workshops or places.

Such inspection or testing shall not release the Contractor from any obligation under the Contract.

37.3 Dates for Inspection and Testing

The Contractor shall agree with the Engineer on the time and place for the inspection or testing of any materials or Plant as provided in the Contract. The Engineer shall give the Contractor not less than 24 hours notice of his intention to carry out the inspection or to attend the tests. If the Engineer, or his duly authorised representative, does not attend on the date agreed, the Contractor may, unless otherwise instructed by the Engineer, proceed with the tests, which shall be deemed to have been made in the presence of the Engineer. The Contractor shall forthwith forward to the Engineer duly certified copies of the tests readings. If the Engineer has not attended the tests, he shall accept the said readings as accurate

If, at the time and place agreed in accordance with Sub-Clause 37.3, the materials or Plant are not ready for inspection or testing or if, as a result of the inspection or testing referred to in this Clause, the Engineer determines that the materials or Plant are defective or otherwise not in accordance with the Contract, he may reject the materials or Plant and shall notify the Contractor thereof immediately.

The notice shall state the Engineer's objections with reasons. The Contractor shall then promptly make good the defect or ensure that rejected materials or Plant comply with the Contract. If the Engineer so requests, the tests of rejected materials or Plant shall be made or repeated under the same terms and conditions. All costs incurred by the Employer by the repetition of the test shall after due consultation with the Employer and the Contractor, be determined by the Engineer and shall be recoverable from the



Contractor by the Employer and may be deducted from any monies due or to become due to the Contractor and the Engineer shall notify the Contractor accordingly, with a copy to the Employer.

37.5 Independent Inspection

The Engineer may delegate inspection and testing of materials or Plant to an independent inspector. Any such delegation shall be effected in accordance with Sub-Clause 2.4 and for this purpose such independent inspector shall be considered as an assistant of the Engineer. Notice of such appointment (not being less than 14 days) shall be given by the Engineer to the Contractor.

38.1 Examination of Work before Covering up

No part of the works shall be covered up or put out of view without the approval of the Engineer and the Contractor shall afford full opportunity for the Engineer to examine and measure any such part of the Works which is about to be covered up or put out of view and to examine foundations before any part of the Works is placed thereon. The Contractor shall give notice to the Engineer whenever any such part of the Works or foundations is or are ready or about to be ready for examination and the Engineer shall, without unreasonable delay, unless he considers it unnecessary and advises the Contractor accordingly, attend for the purpose of examining and measuring such part of the Works or of examining such foundations.

38.2 Uncovering and Making Openings

The Contractor shall uncover any part of the Works or make openings in or through the same as the Engineer may from time to time instruct and shall reinstate and make good such part. If any such part has been covered up or put out of view after compliance with the requirement of Sub-Clause 38.1 and is found to be executed in accordance with the Contract, the Engineer shall, after due consultation with the Employer and the Contractor, determine the amount the Contractor's costs in respect of such of uncovering, making openings in or through, reinstating and making good the same, which shall be added to the Contract Price, and shall notify the Contractor accordingly, with a copy to the Employer. In any other case all costs shall be borne by the Contractor.

39.1 Removal of Improper Work, Materials or Plant

The Engineer shall have authority to issue instructions from time to time, for:

- (a) the removal from the Site, within such time or times as may be specified in the instruction, of any materials or Plant which, in the opinion of the Engineer, are not in accordance with the Contract,
- (b) the substitution of proper and suitable materials or Plant, and
- (c) the removal and proper re-execution, notwithstanding any previous test thereof or interim payment therefore, of any work which, in respect of



- (i) materials, Plant or workmanship, or
- (ii) design by the Contractor or for which he is responsible,

is not, in the opinion of the Engineer, in accordance with the Contract.

39.2 Default of Contractor in Compliance

In case of default on the part of Contractor in carrying out such instruction within the time specified therein or, if none, within a reasonable time, the Employer shall be entitled to employ and pay other persons to carry out the same and all costs consequent thereon or incidental thereto shall, after due consultation with the Employer and the Contractor, be determined by the Engineer and shall be recoverable from the Contractor by the Employer, and may be deducted by the Employer from any monies due or to become due to the Contractor and the Engineer shall notify the Contractor accordingly, with a copy to the Employer.

Suspension

40.1 Suspension of Work

The Contractor shall, on the instructions of the Engineer, suspend the progress of the Works or any part thereof for such time and in such manner as the Engineer may consider necessary and shall, during such suspension, properly protect and secure the Works or such part thereof so far as is necessary in the opinion of the Engineer. Unless such suspension is:

- (a) otherwise provided for in the Contract,
- (b) necessary by reason of some default of or breach of contract by the Contractor or for which he is responsible,
- (c) necessary by reason of climatic conditions of the Site, or
- (d) necessary for the proper execution of the Works or for the safety of the Works or any part thereof (save to the extent that such necessity arises from any act or default by the Engineer or the Employer or from any of the risks defined in Sub-Clause 20.4), Sub-Clause 40.2 shall apply.

40.2 Engineer's Determination following Suspension

Where, pursuant to Sub-Clause 40.1, this Sub-Clause applies the Engineer shall, after due consultation with the Employer and the Contractor, determine:

- (a) any extension of time to which the Contractor is entitled under Clause 44, and
- (b) the amount, which shall be added to the Contract Price, in respect of the cost incurred by the Contractor by reason of such suspension,



and shall notify the Contractor accordingly, with a copy to the Employer.

40.3 Suspension lasting more than 84 Days

If the progress of the Works or any part thereof is suspended on the written instructions of the Engineer and if permission to resume work is not given by the Engineer within a period for 84 days from the date of suspension then, unless such suspension is within paragraph (a), (b), (c) or (d) of Sub-Clause 40.1, the Contractor may give notice to the Engineer requiring permission, within 28 days from the receipt thereof, to proceed with the Works or that part thereof in regard to which progress is suspended. If, within the said time, such permission is not granted, the Contractor may, but is not bound to, elect to treat the suspension, where it affects part only of the Works, as an omission of such part under Clause 51 by giving a further notice to the Engineer to that effect, or, where it affects the whole of the Works, treat the suspension as an event of default by the Employer and terminates his employment under the Contract in accordance with the provisions of Sub-Clause 69.1, whereupon the provisions of Sub-Clause 69.2 and 69.3 shall apply.

Commencement and Delays

41.1 Commencement of Works

The Contractor shall commence the Works as soon as is reasonably possible after the receipt by him of notice to this effect from the Engineer, which notice shall be issued within the time stated in the Appendix to Tender after the date of the Letter of Acceptance. Thereafter, the Contractor shall proceed with the Works with due expedition and without delay.

42.1 Possession of Site and Access Thereto

Save insofar as the Contract may prescribe:

- (a) the extent of portions of the Site of which the Contractor is to be given possession from time to time,
- (b) the order in which such portions shall be made available to the Contractor, and, subject to any requirement in the Contract as to the order in which the Works shall be executed, the Employer will, with the Engineer's notice to commence the Works, give to the Contractor possession of
- (c) so much of the Site, and
- (d) such access as, in accordance with the Contract, is to be provided by the Employer as may be required to enable the Contractor to commence and proceed with the execution of the Works in accordance with the programme referred to in Clause 14, if any, and otherwise in accordance with such reasonable proposals as the Contractor shall, by notice to the Engineer with a copy to the Employer, make. The Employer will, from time to time as the Works proceed, give to the Contractor possession of such further portions of the Site as may be required to enable the



Contractor to proceed with the execution of the Works with due dispatch in accordance with such programme or proposals, as the case may be.

42.2 Failure to Give Possession

If the Contractor suffers delay and/or incurs costs from failure on the part of the Employer to give possession in accordance with the terms of Sub-Clause 42.1, the Engineer shall, after due consultation with the Employer and the Contractor, determine:

- (a) any extension of time to which the Contractor is entitled under Clause 44, and
- (b) the amount of such costs, which shall be added to the Contract Price,

and shall notify the Contractor accordingly, with a copy to the Employer.

42.3 Rights of Way and Facilities

The Contractor shall bear all costs and charges for special or temporary way leaves required by him in connection with access to the Site. The Contractor shall also provide at his own cost any additional facilities outside the Site required by him for the purposes of the Works.

43.1 Time for Completion

The whole of the Works and, if applicable, any Section required to be completed within a particular time as stated in the Appendix to Tender, shall be completed, in accordance with the provisions of Clause 48, within the time stated in the Appendix to Tender for the whole of the Works or the Section (as the case may be), calculated from the Commencement Date, or such extended time as may be allowed under Clause 44.

44.1 Extension of Time for Completion

In the event of:

- (a) the amount or nature of extra or additional work,
- (b) any cause of delay referred to in these Conditions,
- (c) exceptionally adverse climatic conditions,
- (d) any delay, impediment or prevention by the Employer, or
- (e) other special circumstances which may occur, other than through a default of or breach of contract by the Contractor or for which he is responsible,

being such as fairly to entitle the Contractor to an extension of the Time for Completion of the Works, or any Section or part thereof, the Engineer may, after



due consultation with the Employer and the Contractor, consider the amount of such extension or otherwise and shall notify the Contractor accordingly, with a copy to the Employer.

44.2 Contractor to Provide Notification and Detailed Particulars

Provided that the Engineer is not bound to make any consideration unless the Contractor has

(a) within 14 days after such event has first arisen notified the Engineer with a copy to the Employer, and

(b) within 14 days or such other reasonable time as may be agreed by the Engineer, after such notification submitted to the Engineer detailed particulars of any extension of time to which he may consider himself entitled in order that such submission may be investigated at the time.

44.3 Interim Determination of Extension

Provided also that where an event has a continuing effect such that it is not practicable for the Contractor to submit detailed particulars within the period of 14 days referred to in Sub-Clause 44.2(b), he shall nevertheless be entitled to an extension of time provided that he has submitted to the Engineer interim particulars at intervals of not more than 14 days and final particulars within 14 days of the end of the effects resulting from the event. On receipt of such interim particulars, the Engineer shall, without undue delay, make an interim determination of extension of time and, on receipt of the final particulars, the Engineer shall review all the circumstances and shall determine an overall extension of time in regard to the event. In both such cases the Engineer shall make his determination after due consultation with the Employer and the Contractor and shall notify the Contractor of the determination, with a copy to the Employer. No final review shall result in a decrease of any extension of time already determined by the Engineer.

45.1 Restriction on Working Hours

Subject to any provision to the contrary contained in the Contract, none of the Works shall, save as hereinafter provided, be carried on during the night or on locally recognized days of rest without the consent of the Engineer, except when work is unavoidable or absolutely necessary for the saving of life or property or for the safety of the Works, in which case the Contractor shall immediately advise the Engineer. Provided that the provisions of this Clause shall not be applicable in the case of any work which it is customary to carry out by multiple shifts.

46.1 Rate of Progress

If for any reason, which does not entitle the Contractor to an extension of time, the rate of progress of the Works or any Section is at any time, in the opinion of the Engineer, too slow to comply with the Time for Completion, the Engineer shall so notify the Contractor who shall thereupon take such steps as are necessary,



subject to the consent of the Engineer, to expedite progress so as to comply with the Time for Completion. The Contractor shall not be entitled to any additional payment for taking such steps. If, as a result of any notice given by the Engineer under this Clause, the Contractor considers that it is necessary to do any work at night or on locally recognized days of rest, he shall be entitled to seek the consent of the Engineer so to do. Provided that if any steps, taken by the Contractor in meeting his obligations under this Clause, involve the Employer in additional supervision costs, such cost shall, after due consultation with the Employer and the Contractor, be determined by the Engineer and shall be recoverable from the Contractor by the Employer, and may be deducted by the Employer from any monies due or to become due to the Contractor and the Engineer shall notify the Contractor accordingly, with a copy to the Employer.

47.1 Liquidated Damages for Delay

If the Contractor fails to comply with the Time for Completion in accordance with Clause 48, for the whole of the Works or, if applicable, any Section within the relevant time prescribed by Clause 43, then the Contractor shall pay to the Employer the relevant sum stated in the Appendix to Tender as liquidated damages for such default and not as a penalty (which sum shall be the only monies due from the Contractor for such default) for every day or part of a day which shall elapse between the relevant Time for Completion and the date stated in a Taking- Over Certificate of the whole of the Works or the relevant Section, subject to the applicable limit stated in the Appendix to Tender. The Employer may, without prejudice to any other method of recovery, deduct the amount of such damages from any monies due or to become due to the Contractor. The payment or deduction of such damages shall not relieve the Contractor from his obligation to complete the Works, or from any other of his obligations and liabilities under the Contract.

47.2 Reduction of Liquidated Damages

If, before the Time for Completion of the whole of the Works or, if applicable, any Section, a Taking-Over Certificate has been issued for any part of the Works or of a Section, the liquidated damages for delay in completion of the remainder of the Works or of that Section shall, for any period of delay after the date stated in such Taking-Over Certificate, and in the absence of Alternative provisions in the Contract, be reduced in the proportion which the value of the part so certified bears to the value of the whole of the Works or Section, as applicable. The provisions of this Sub-Clause shall only apply to the rate of liquidated damages and shall not affect the limit thereof.

48.1 Taking-Over Certificate

When the whole of the Works have been substantially completed and have satisfactorily passed any Tests on Completion prescribed by the Contract, the Contractor may give a notice to that effect to the Engineer with a copy to the Employer, accompanied by a written undertaking to finish with due expedition any outstanding work during the Defects Liability Period. Such notice and undertaking



shall be deemed to be a request by the Contractor for the Engineer to issue a Taking-Over Certificate in respect of the Works. The Engineer shall within 21 days of the date of delivery of such notice, either issue to the Contractor, with a copy to the Employer, a Taking-Over Certificate, stating the date on which, in his opinion, the Works were substantially completed in accordance with the Contract, or give instructions in writing to the Contractor specifying all the work which, in the Engineer's opinion, is required to be done by the Contractor before the issue of such Certificate. The Engineer shall also notify the Contractor of any defects in the Works affecting substantial completion that may appear after such instructions and before completion of the Works specified therein. The Contractor shall be entitled to receive such Taking-Over Certificate within 21 days of completion, to the satisfaction of the Engineer, of the Works so specified and remedying any defects so notified.

48.2 Taking Over of Sections or Parts

Similarly, in accordance with the procedure set out in Sub-Clause 48.1, the Contractor may request and the Engineer shall issue a Taking-Over Certificate in respect of:

- (a) any Section in respect of which a separate Time for Completion is provided in the Appendix to Tender,
- (b) any substantial part of the Permanent Works which has been both completed to the satisfaction of the Engineer and, otherwise than as provided for in the Contract, occupied or used by the Employer, or
- (c) any part of the Permanent Works which the Employer has elected to occupy or use prior to completion (where such prior occupation or use is not provided for in the Contract or has not been agreed by the Contractor as a temporary measure).

48.3 Substantial Completion of Parts

If any part of the Permanent Works has been substantially completed and has satisfactorily passed any Tests on Completion prescribed by the Contractor, the Engineer may issue a Taking-Over Certificate in respect of that part of the Permanent Works before completion of the whole of the Works and, upon the issue of such Certificate, the Contractor shall be deemed to have undertaken to complete with due expedition any outstanding work in that part of the Permanent Works during the Defects Liability Period.

48.4 Surfaces Requiring Reinstatement

Provided that a Taking-Over Certificate given in respect of any Section or part of the Permanent Works before completion of the whole of the Works shall not be deemed to certify completion of any ground or surfaces requiring reinstatement, unless such Taking-Over Certificate shall expressly so state.



Defects Liability

49.1 Defects Liability Period

In these Conditions the expression "Defects Liability Period" shall mean the defects liability period named in the Appendix to Tender, calculated from:

- (a) the date of completion of the Works certified by the Engineer in accordance with Clause 48, or
- (b) in the event of more than one certificate having issued by the Engineer under Clause 48, the respective dates so certified,

and in relation to the Defects Liability Period the expression "the Works" shall be construed accordingly.

49.2 Completion of Outstanding Work and Remedying Defects

To the intent that the Works shall, at or as soon as practicable after the expiration of the Defects Liability Period, be delivered to the Employer in the condition required by the Contract, fair wear and tear excepted, to the satisfaction of the Engineer, the Contractor shall:

- (a) complete the work, if any, outstanding on the date stated in the Taking-Over Certificate as soon as practicable after such date, and
- (b) execute all such work of amendment, reconstruction, and remedying defects, shrinkages or other faults as the Engineer may, during the Defects Liability Period or within 14 days after its expiration, as a result of an inspection made by or on behalf of the Engineer prior to its expiration, instruct the Contractor to execute.

49.3 Cost of Remedying Defects

All work referred to in Sub-Clause 49.2(b) shall be executed by the Contractor at his own cost if the necessity thereof is, in the opinion of the Engineer, due to:

- (a) the use of materials, Plant or workmanship not in accordance with the Contract,
- (b) where the Contractor is responsible for the design of part of the Permanent Works, any fault in such design, or
- (c) the neglect or failure on the part of the Contractor to comply with any obligation, expressed or implied, on the Contractor's part under the Contract.

If, in the opinion of the Engineer, such necessity is due to any other cause, he shall determine an addition to the Contract Price in accordance with Clause 52 and shall notify the Contractor accordingly, with a copy to the Employer.



49.4 Contractor's Failure to Carry Out Instructions

In case of default on the part of the Contractor in carrying out such instruction within a reasonable time, the Employer shall be entitled to employ and pay other persons to carry out the same and if such work is work which, in the opinion of the Engineer, the Contractor was liable to do at his own cost under the Contract, then all cost consequent thereon or incidental thereto shall, after due consultation with the Employer and the Contractor, be determined by the Engineer and shall be recoverable from the Contractor by the Employer, and may be deducted by the Employer from any monies due or to become due to the Contractor and the Engineer shall notify the Contractor accordingly, with a copy to the Employer.

50.1 Contractor to Search

If any defect, shrinkage or other fault in the Works appears at any time prior to the end of the Defects Liability Period, the Engineer may instruct the Contractor, with a copy to the Employer, to search under the directions of the Engineer for the cause thereof. Unless such defect, shrinkage or other fault is one for which the Contractor is liable under the Contract, the Engineer shall, after due consultation with the Employer and the Contractor, determine the amount in respect of the costs of such search incurred by the Contractor, which shall be added to the Contract Price and shall notify the Contractor accordingly, with a copy to the Employer. If such defect, shrinkage or other fault is one for which the Contractor is liable, the cost of the work carried out in searching as aforesaid shall be borne by the Contractor and he shall in such case remedy such defect, shrinkage or other fault at his own cost in accordance with the provisions of Clause 49.

Alterations, Additions and Omissions

51.1 Variations

The Engineer shall make any variation of the form, quality or quantity of the Works or any part thereof that may, in his opinion, be necessary and for that purpose, or if for any other reason it shall, in his opinion, be appropriate, he shall have the authority to instruct the Contractor to do and the Contractor shall do any of the following:

- (a) increase or decrease the quantity of any work included in the Contract,
- (b) omit any such work (but not if the omitted work is to be carried out by the Employer or by another contractor),
- (c) change the character or quality or kind of any such work,
- (d) change the levels, lines, position and dimensions of any part of the Works,
- (e) execute additional work of any kind necessary for the completion of the Works,
or
- (f) change any specified sequence or timing of construction of any part of the Works.

No such variation shall in any way vitiate or invalidate the Contract, but the effect, if any, of all such variations shall be valued in accordance with Clause 52. Provided that where the issue of an instruction to vary the Works is necessitated by some default of



or breach of contract by the Contractor or for which he is responsible, any additional cost attributable to such default shall be borne by the Contractor.

51.2 Instructions for Variations

The Contractor shall not make any such variation without an instruction of the Engineer. Provided that no instruction shall be required for increase or decrease in the quantity of any work where such increase or decrease is not the result of an instruction given under this Clause, but is the result of the quantities exceeding or being less than those stated in the Bill of Quantities.

52.1 Valuation of Variations

All variations referred to in Clause 51 and any additions to the Contract Price which are required to be determined in accordance with Clause 52 (for the purposes of this Clause referred to as "varied work"), shall be valued at the rates and prices set out in the Contract if, in the opinion of the Engineer, the same shall be applicable. If the Contract does not contain any rates or prices applicable to the varied work, the rates and prices in the Contract shall be used as the basis for valuation so far as may be reasonable, failing which, after due consultation by the Engineer with the Employer and the Contractor, suitable rates or prices shall be agreed upon between the Engineer and the Contractor. In the event of disagreement the Engineer shall fix such rates or prices as are, in his opinion, appropriate and shall notify the Contractor accordingly, with a copy to the Employer. Until such time as rates or prices are agreed or fixed, the Engineer shall determine provisional rates or prices to enable on-account payments to be included in certificates issued in accordance with Clause 60.

52.2 Power of Engineer to Fix Rates

Provided that if the nature or amount of any varied work relative to the nature or amount of the whole of the Works or to any part thereof, is such that, in the opinion of the Engineer, the rate or price contained in the Contract for any item of the Works is, by reason of such varied work, rendered inappropriate or inapplicable, then, after due consultation by the Engineer with the Employer and the Contractor, a suitable rate or price shall be agreed upon between the Engineer and the Contractor. In the event of disagreement the Engineer shall fix such other rate or price as is, in his opinion, appropriate and shall notify the Contractor accordingly, with a copy to the Employer. Until such time as rates or prices are agreed or fixed, the Engineer shall determine provisional rates or prices to enable on-account payments to be included in certificates issued in accordance with Clause 60.

Provided also that no varied work instructed to be done by the Engineer pursuant to Clause 51 shall be valued under Sub-Clause 52.1 or under this Sub-Clause unless, within 14 days of the date of such instruction and, other than in the case of omitted work, before the commencement of the varied work, notice shall have been given either:

- (a) by the Contractor to the Engineer of his intention to claim extra payment or a varied rate or price, or



(b) by the Engineer to the Contractor of his intention to vary a rate or price.

52.3 Variations Exceeding 15 per cent

If, on the issue of the Taking-Over Certificate for the whole of the Works, it is found that as a result of:

- (a) all varied work valued under Sub-Clauses 52.1 and 52.2, and
- (b) all adjustments upon measurement of the estimated quantities set out in the Bill of Quantities, excluding Provisional Sums, day works and adjustment of price made under Clause 70.

but not from any other cause, there have been additions to or deductions from the Contract Price which taken together are in excess of 15 per cent of the "Effective Contract Price" (which for the purposes of this Sub-Clause shall mean the Contract Price, excluding Provisional Sums and allowance for day works, if any) then and in such event (subject to any action already taken under any other Sub-Clause of this Clause), after due consultation by the Engineer with the Employer and the Contractor, there shall be added to or deducted from the Contract Price such further sums as may be agreed between the Contractor and the Engineer or, failing agreement, determined by the Engineer having regard to the Contractor's Site and general overhead costs of the Contract. The Engineer shall notify the Contractor of any determination made under this Sub-Clause, with a copy to the Employer. Such sum shall be based only on the amount by which such additions or deductions shall be in excess of 15 per cent of the Effective Contract Price.

52.4 Day work

The Engineer may, if in his opinion it is necessary or desirable, issue an instruction that any varied work shall be executed on a day work basis. The Contractor shall then be paid for such varied work under the terms set out in the day work schedule included in the Contract and at the rates and prices affixed thereto by him in the Tender.

The Contractor shall furnish to the Engineer such receipts or other vouchers as may be necessary to provide the amounts paid and, before ordering material, shall submit to the Engineer quotations for the same for his approval.

In respect of such of the Works executed on a day work basis, the Contractor shall during the continuance of such work, deliver each day to the Engineer an exact list in duplicate of the names, occupation and time of all workmen employed on such work and a statement, also in duplicate, showing the description and quantity of all materials and Contractor's Equipment used thereon or therefore other than Contractor's Equipment which is included in the percentage addition in accordance with such day work schedule. One copy of each list and statement will, if correct, or when agreed, be signed by the Engineer and returned to the Contractor.



At the end of each month the Contractor shall deliver to the Engineer a priced statement of the labour, materials and Contractor's Equipment, except as aforesaid, used and the Contractor shall not be entitled to any payment unless such lists and statements have been fully and punctually rendered. Provided always that if the Engineer considers that for any reason the sending of such lists or statements by the Contractor, in accordance with the foregoing provision, was impracticable he shall nevertheless be entitled to authorize payment for such work, either as day work, on being satisfied as to the time employed and the labour, materials and Contractor's Equipment used on such work, or at such value therefore as shall, in his opinion, be fair and reasonable.

Procedure for Claims

53.1 Notice of Claims

Notwithstanding any other provision of the Contract, if the Contractor intends to claim any additional payment pursuant to any Clause of these Conditions or otherwise, he shall give notice along with supporting documents of his intention to the Engineer with a copy to the Employer, within 28 days after the event giving rise to the claim has first arisen.

53.2 Contemporary Records

Upon the happening of the event referred to in Sub-Clause 53.1, the Contractor shall keep such contemporary records as may reasonably be necessary to support any claim he may subsequently wish to make. Without necessarily admitting the Employer's liability, the Engineer shall, on receipt of a notice under Sub-Clause 53.1, inspect such contemporary records and may instruct the Contractor to keep any further contemporary records as are reasonable and may be material to the claim of which notice has been given. The Contractor shall permit the Engineer to inspect all records kept pursuant to this Sub-Clause and shall supply him with copies thereof as and when the Engineer so instructs.

53.3 Substantiation of Claims

Within 28 days, or such other reasonable time as may be agreed by the Engineer, of giving notice under Sub-Clause 53.1, the Contractor shall send to the Engineer an account giving detailed particulars of the amount claimed and the grounds upon which the claim is based. Where the event giving rise to the claim has a continuing effect, such account shall be considered to be an interim account and the Contractor shall, at such intervals as the Engineer may reasonably require, send further interim accounts giving the accumulated amount of the claim and any further grounds upon which it is based. In cases where interim accounts are sent to the Engineer, the Contractor shall send a final account within 28 days of the end of the effects resulting from the event. The Contractor shall, if required by the Engineer so to do, copy to the Employer all accounts sent to the Engineer pursuant to this Sub-Clause.



53.4 Failure to Comply

If the Contractor fails to comply with any of the provisions of this Clause in respect of any claim which he seeks to make, his entitlement to payment in respect thereof shall not exceed such amount as the Engineer or any arbitrator or arbitrators appointed pursuant to Sub-Clause 67.3 assessing the claim considers to be verified by contemporary records (whether or not such records were brought to the Engineer's notice as required under Sub-Clause 53.2 and 53.3).

53.5 Payment of Claims

The Contractor shall be entitled to have included in any interim payment certified by the Engineer pursuant to Clause 60 such amount in respect of any claim as the Engineer, after due consultation with the Employer and the Contractor, may consider due to the Contractor provided that the Contractor has supplied sufficient particulars to enable the Engineer to determine the amount due. If such particulars are insufficient to substantiate the whole of the claim, the Contractor shall be entitled to payment in respect of such part of the claim as such particulars may substantiate to the satisfaction of the Engineer. The Engineer shall notify the Contractor of any determination made under this Sub-Clause, with a copy to the Employer.

Contractor's Equipment, Temporary Works and Materials

54.1 Contractor's Equipment, Temporary Works and Materials; Exclusive Use for the Works

All Contractor's Equipment, Temporary Works and materials provided by the Contractor shall, when brought on to the Site, be deemed to be exclusively intended for the execution of the Works and the Contractor shall not remove the same or any part thereof, except for the purpose of moving it from one part of the Site to another, without the consent of the Engineer. Provided that consent shall not be required for vehicles engaged in transporting any staff, labour, Contractor's Equipment, Temporary Works, Plant or materials to or from the Site.

54.2 Employer not Liable for Damage

The Employer shall not at any time be liable, save as mentioned in Clauses 20 and 65, for the loss of or damage to any of the said Contractor's Equipment, Workforce, Temporary Works or Materials.

54.3 Customs Clearance

The Employer will use his best endeavors in assisting the Contractor, where required, in obtaining clearance through the Customs of Contractor's equipment, materials and other things required for the Works.



54.4 Re-export of Contractor's Equipment

In respect of any Contractor's Equipment which the Contractor has imported for the purposes of the Works, the Employer will use his best endeavors to assist the Contractor, where required, in procuring any necessary Government consent to the re-export of such Contractor's Equipment by the Contractor upon the removal thereof pursuant to the terms of Contract.

54.5 Conditions of Hire of Contractor's Equipment

With a view to securing, in the event of termination under Clause 63, the continued availability, for the purpose of executing the Works, of any hired Contractor's Equipment, the Contractor shall not bring on to the Site any hired Contractor's Equipment unless there is an agreement for hire thereof (which agreement shall be deemed not to include an agreement for hire purchase) which contains a provision that the owner thereof will, on request in writing made by the Employer within 7 days after the date on which any termination has become effective, and on the Employer undertaking to pay all hire charges in respect thereof from such date, hire such Contractor's Equipment to the Employer on the same terms in all respect as the same was hired to the Contractor save that the Employer shall be entitled to permit the use thereof by any other contractor employed by him for the purpose of execution and completing the Works and remedying any defects therein, under the terms of the said Clause 63.

54.6 Costs for the Purpose of Clause 63

In the event of the Employer entering into any agreement for the hire of Contractor's Equipment pursuant to Sub-Clause 54.5, all sums properly paid by the Employer under the provision of any such agreement and all costs incurred by him (including stamp duties) in entering into such agreement shall be deemed, for the purpose of Clause 63, to be part of the cost of executing and completing the Works and the remedying of any defects therein.

54.7 Incorporation of Clause in Subcontracts

The Contractor shall, where entering into any subcontract for the execution of any part of the Works, incorporate in such subcontract (by reference or otherwise) the provisions of this Clause in relation to Contractor's Equipment, Temporary Works or materials brought on to the Site by the Subcontractor.

54.8 Approval of Materials not implied

The operation of this Clause shall not be deemed to imply any approval by the Engineer of the materials or other matters referred to therein nor shall it prevent the rejection of any such materials at any time by the Engineer.



Measurement

55.1 Quantities

The quantities set out in the Bill of Quantities are the estimated quantities for the Works, and they are not to be taken as the actual and correct quantities of the Works to be executed by the Contractor in fulfillment of his obligations under the Contract.

56.1 Works to be measured

The Engineer shall, except as otherwise stated, ascertain and determine by measurement the value of the Works in accordance with the Contract and the Contractor shall be paid that value in accordance with Clause 60. The Engineer shall, when he requires any part of the Works to be measured, give reasonable notice to the Contractor's authorized agent, who shall:

- (a) forthwith attend or send a qualified representative to assist the Engineer in making such measurement, and
- (b) supply all particulars required by the Engineer.

Should the Contractor not attend, or neglect or omit to send such representative, then the measurement made by the Engineer or approved by him shall be taken to be the correct measurement of such part of the Works. For the purpose of measuring such Permanent Works as are to be measured by records and drawings, the Engineer shall prepare records and drawings as the work proceeds and the Contractor, as and when called upon to do so in writing, shall, within 14 days, attend to examine and agree such records and drawings with the Engineer and shall sign the same when so agreed. If the Contractor does not attend to examine and agree such records and drawings, they shall be taken to be correct. If, after examination of such records and drawings, the Contractor does not agree the same or does not sign the same as agreed, they shall nevertheless be taken to be correct, unless the Contractor, within 14 days of such examination, lodges with the Engineer notice of the respects in which such records and drawings are claimed by him to be incorrect. On receipt of such notice, the Engineer shall review the records and drawings and either confirm or vary them.

57.1 Method of Measurement

The Works shall be measured net, notwithstanding any general or local custom, except where otherwise provided for in the Contract.



57.2 Breakdown of Lump Sum Items

For the purposes of statements submitted in accordance with Sub-Clause 60.1, the Contractor shall submit to the Engineer, within 28 days after the receipt of the Letter of Acceptance, a breakdown for each of the lump sum items contained in the Tender. Such breakdowns shall be subject to the approval of the Engineer.

Provisional Sums

58.1 Definition of "Provisional Sum"

"Provisional Sum" means a sum included in the Contract and so designated in the Bill of Quantities for the execution of any part of the Works or for the supply of goods, materials, Plant or services, or for contingencies, which sum may be used, in whole or in part, or not at all, on the instructions of the Engineer. The Contractor shall be entitled to only such amounts in respect of the work, supply or contingencies to which such Provisional Sums relate as the Engineer shall determine in accordance with this Clause. The Engineer shall notify the Contractor of any determination made under this Sub-Clause, with a copy to the Employer.

58.2 Use of Provisional Sums

In respect of every Provisional Sum the Engineer shall have authority to issue instructions for the execution of work or for the supply of goods, material, Plant or services by:

- (a) the Contractor, in which case the Contractor shall be entitled to an amount equal to the value thereof determined in accordance with Clause 52, and
- (b) a nominated Subcontractor, as hereinafter defined, in which case the sum to be paid to the Contractor therefore shall be determined and paid in accordance with Sub-Clause 59.4.

58.3 Production of Vouchers

The Contractor shall produce to the Engineer all quotations, invoices, vouchers and accounts or receipts in connection with expenditure in respect of Provisional Sums, except where work is valued in accordance with rates or prices set out in the Tender.



Nominated Subcontractors

59.1 Definition of "Nominated Subcontractors"

All specialists, merchants, tradesmen and others executing any work or supplying any goods, materials, Plant or services for which Provisional Sums are included in the Contract, who may have been or be nominated or selected or approved by the Employer or the Engineer, and all persons to whom by virtue of the provisions of the Contract the Contractor is required to subcontract shall, in the execution of such work or the supply of such goods, materials, Plant or services, be deemed to be subcontractors to the Contractor and are referred to in this Contract as "nominated Subcontractors".

59.2 Nominated Subcontractors; Objection to Nomination

The Contractor shall not be required by the Employer or the Engineer, or be deemed to be under any obligation, to employ any nominated Subcontractor against whom the Contractor may raise reasonable objection or who declines to enter into subcontract with the Contractor containing provisions:

- (a) that in respect of the work, goods, materials, Plant or services the subject of the subcontract, the nominated Subcontractor will undertake towards the Contractor such obligations and liabilities as will enable the Contractor to discharge his own obligations and liabilities towards the Employer under the terms of the Contract and will save harmless and indemnify the Contractor from and against the same and from all claims, proceedings, damages, costs, charges and expenses whatsoever arising out of or in connection therewith, or arising out of or in connection with any failure to perform such obligations or to fulfill such liabilities, and
- (b) that the nominated Subcontractor will save harmless and indemnify the Contractor from and against any negligence by the nominated Subcontractor, his agents, workmen and servants and from and against any misuse by him or them of any Temporary Works provided by the Contractor for the purposes of the Contract and from all claims as aforesaid.

59.3 Design Requirements to be expressly stated

If in connection with any Provisional Sum the services to be provided include any matter of design or specification of any part of the Permanent Works or of any Plant to be incorporated therein, such requirement shall be expressly stated in the Contract and shall be included in any nominated Subcontract. The nominated Subcontract shall specify that the nominated Subcontractor providing such services will save harmless and indemnify



the Contractor from and against the same and from all claims, proceedings, damages, costs, charges and expenses whatsoever arising out of or in connection with any failure to perform such obligations or to fulfill such liabilities.

59.4 Payments to Nominated Subcontractors

For all work executed or goods, materials, Plant or services supplied by any nominated Subcontractor, the Contractor shall be entitled to:

- (a) the actual price paid or due to be paid by the Contractor, on the instructions of the Engineer, and in accordance with the subcontract;
- (b) in respect of labour supplied by the Contractor, the sum, if any, entered in the Bill of Quantities or, if instructed by the Engineer pursuant to paragraph (a) of Sub-Clause 58.2, as may be determined in accordance with Clause 52; and
- (c) in respect of all other charges and profit, a sum being a percentage rate of the actual price paid or due to be paid calculated, where provision has been made in the Bill of Quantities for a rate to be set against the relevant Provisional Sum, at the rate inserted by the Contractor against that item or, where no such provision has been made, at the rate inserted by the Contractor in the Appendix to Tender and repeated where provision for such is made in a special item provided in the Bill of Quantities for such purpose.

59.5 Certification of Payments to Nominated Subcontractors

Before issuing, under Clause 60 any certificate, which includes any payment in respect of work done or goods, materials, Plant or services supplied by any nominated Subcontractor, the Engineer shall be entitled to demand from the Contractor reasonable proof that all payments, less retentions, included in previous certificates in respect of the work or goods, materials, Plant or services of such nominated Subcontractor have been paid or discharged by the Contractor. If the Contractor fails to supply such proof then, unless the Contractor:

- (a) Satisfies the Engineer in writing that he has reasonable cause for withholding or refusing to make such payment, and
- (b) produces to the Engineer reasonable proof that he has so informed such nominated Subcontractor in writing,

the Employer shall be entitled to pay to such nominated Subcontractor direct, upon the certificate of the Engineer, all payments, less



retention, provided for in the nominated Subcontract, which the Contractor has failed to make to such nominated Subcontractor and to deduct by way of set-off the amount so paid by the Employer from any sums due or to become due from the Employer to the Contractor.

Provided that, where the Engineer has certified and the Employer has paid direct as aforesaid, the Engineer shall in issuing any further certificate in favour of the Contractor, deduct from the amount thereof the amount so paid, direct as aforesaid, but shall not withhold or delay the issue of the certificate itself when due to be issued under the terms of the Contract.

Certificates and Payment

60.1 Monthly Statements

The Contractor shall submit to the Engineer after the end of each month six copies, each signed by the Contractor's representative approved by the Engineer in accordance with the Sub-Clause 15.1, of a statement, in such form as the Engineer may from time to time prescribe, showing the amounts to which the Contractor considers himself to be entitled up to the end of the month in respect of:

- (a) the value of the Permanent Works executed,
- (b) any other items in the Bill of Quantities including those for Contractor's Equipment, Temporary Works, day works and the like,
- (c) the percentage of the invoice value of listed materials, all as stated in the Appendix to Tender, and Plant delivered by the Contractor on the Site for incorporation in the Permanent Works but not incorporated in such Works,
- (d) Adjustments under Clause 70, and
- (e) any other sum to which the Contractor may be entitled under the Contract or otherwise.

60.2 Monthly Payments

The Engineer shall, within 28 days of receiving such statement, certify to the Employer the amount of payment to the Contractor which he considers due and payable in respect thereof, subject:

- (a) firstly, to the retention of the account calculated by applying the Percentage of Retention stated in the Appendix to Tender, to



the amount to which the Contractor is entitled under paragraph (a), (b), (c) and (e) of Sub-Clause 60.1 until the amount so retained reaches the Limit of Retention Money stated in the Appendix to Tender, and

- (b) secondly, to the deduction, other than pursuant to Clause 47, of any sums which may have become due and payable by the Contractor to the Employer.

Provided that the Engineer shall not be bound to certify any payment under this Sub- Clause if the net amount thereof, after all retentions and deductions, would be less than the Minimum Amount of Interim Payment Certificates stated in the Appendix to Tender.

Notwithstanding the terms of this Clause or any other Clause of the Contract no amount will be certified by the Engineer for payment until the performance security, if required under the Contract, has been provided by the Contractor and approved by the Employer.

60.3 Payment of Retention Money

- (a) Upon the issue of the Taking-Over Certificate with respect to the whole of the Works, one half of the Retention Money, or upon the issue of a Taking-Over Certificate with respect to a Section or part of the Permanent Works only such proportion thereof as the Engineer determines having regard to the relative value of such Section or part of the Permanent Works, shall be certified by the Engineer for payment to the Contractor.
- (b) Upon the expiration of the Defects Liability Period for the Works the other half of the Retention Money shall be certified by the Engineer for payment to the Contractor. Provided that, in the event of different Defects Liability Periods having become applicable to different Sections or part of the Permanent Works pursuant to Clause 48, the expression "expiration of the Defects Liability Period" shall, for the purposes of this Sub-Clause, be deemed to mean the expiration of the latest of such periods. Provided also that if at such time, there shall remain to be executed by the Contractor any work instructed, pursuant to Clause 49 and 50, in respect of the Works, the Engineer shall be entitled to withhold certification until completion of such work of so much of the balance of the Retention Money as shall, in the opinion of the Engineer, represent the cost of the work remaining to be executed.

60.4 Correction of Certificates

The Engineer may by any Interim Payment Certificate make any correction or modification in any previous certificate which shall have



been issued by him and shall have authority, if any work is not being carried out to his satisfaction, to omit or reduce the value of such work in any Interim Payment Certificate.

60.5 Statement at Completion

Not later than 84 days after the issue of the Taking-Over Certificate in respect of the whole of the Works, the Contractor shall submit to the Engineer a Statement at Completion with supporting documents showing in detail, in the form approved by the Engineer:

- (a) the final value of all work done in accordance with the Contract up to the date stated in such Taking-Over Certificate,
- (b) any further sums which the Contractor considers to be due, and
- (c) an estimate of amounts which the Contractor considers will become due to him under the Contract.

The estimated amounts shall be shown separately in such Statement at Completion. The Engineer shall verify payment in accordance with Sub-Clause 60.2.

60.6 Final Statement

Not later than 56 days after the issue of the Defects Liability Certificate pursuant to Sub-Clause 62.1, the Contractor shall submit to the Engineer for consideration a draft final statement with supporting documents showing in detail, in the form approved by the Engineer:

- (a) the value of all work done in accordance with the Contract, and
- (b) any further sums which the Contractor considers to be due to him under the Contract.

If the Engineer disagrees with or cannot verify any part of the draft final statement, the Contractor shall submit such further information as the Engineer may reasonably require and shall make such changes in the draft as may be agreed between them. The Contractor shall then prepare and submit to the Engineer the final statement as agreed (for the purposes of these Conditions referred to as the "Final Statement").

If, following discussions between the Engineer and the Contractor and any changes to the draft final statement which may be agreed between them, it becomes evident that a dispute exists, the Engineer shall deliver to the Employer an Interim Payment Certificate for those parts of the draft final



statement, if any, which are not in dispute. The dispute may then be settled in accordance with Clause 67.

60.7 Discharge

Upon submission of the Final Statement, the Contractor shall give to the Employer, with a copy to the Engineer, a written discharge confirming that the total of the Final Statement represents full and final settlement of all monies due to the Contractor arising out of or in respect of the Contract. Provided that such discharge shall become effective only after payment due under the Final Payment Certificate issued pursuant to Sub-Clause 60.8 has been made and the performance security referred to in Sub-Clause 10.1, if any, has been returned to the Contractor.

60.8 Final Payment Certificate

Within 28 days after receipt of the Final Statement, and the written discharge, the Engineer shall issue to the Employer (with a copy to the Contractor) a Final Payment Certificate stating:

- (a) the amount which, in the opinion of the Engineer, is finally due under the Contract or otherwise, and
- (b) after giving credit to the Employer for all amounts previously paid by the Employer and for all sums to which the Employer is entitled other than under Clause 47, the balance, if any, due from the Employer to the Contractor or from the Contractor to the Employer as the case may be.

60.9 Cessation of Employer's Liability

The Employer shall not be liable to the Contractor for any matter or thing arising out of or in connection with the Contract or execution of the Works, unless the Contractor shall have included a claim in respect thereof in his Final Statement and (except in respect of matters or things arising after the issue of the Taking-Over Certificate in respect of the whole of the Works) in the Statement at Completion referred to in Sub-Clause 60.5.

60.10 Time for Payment

The amount due to the Contractor under any Interim Payment Certificate issued by the Engineer pursuant to this Clause, or to any other term of the Contract, shall, subject to Clause 47, be paid by the Employer to the Contractor within 28 days after such Interim Payment Certificate has been delivered to the Employer, or, in the case of the Final Payment Certificate referred to in Sub-Clause 60.8, within 56 days, after such Final Payment Certificate has been delivered to the Employer. In the event of the failure of



the Employer to make payment within the times stated, the Employer shall pay to the Contractor interest at the rate stated in the Appendix to Tender upon all sums unpaid from the date by which the same should have been paid. The provisions of this Sub-Clause are without prejudice to the Contractor's entitlement under Clause 69 or otherwise.

61.1 Approval only by Defects Liability Certificate

Only the Defects Liability Certificate, referred to in Clause 62, shall be deemed to constitute approval of the Works.

62.1 Defects Liability Certificate

The Contract shall not be considered as completed until a Defects Liability Certificate shall have been signed by the Engineer and delivered to the Employer, with a copy to the Contractor, stating the date on which the Contractor shall have completed his obligations to execute and complete the Works and remedy any defects therein to the Engineer's satisfaction.

The Defects Liability Certificate shall be given by the Engineer within 28 days after the expiration of the Defects Liability Period, or, if different defects liability periods shall become applicable to different Sections or parts of the Permanent Works, the expiration of the latest such period, or as soon thereafter as any works instructed, pursuant to Clause 49 and 50, have been completed to the satisfaction of the Engineer. Provided that the issue of the Defects Liability Certificate shall not be a condition precedent to payment to the Contractor of the second portion of the Retention Money in accordance with the conditions set out in Sub-Clause 60.3.

62.2 Unfulfilled Obligations

Notwithstanding the issue of the Defects Liability Certificate the Contractor and the Employer shall remain liable for the fulfillment of any obligation incurred under the provisions of the Contract prior to the issue of the Defects Liability Certificate which remains unperformed at the time of such Defects Liability Certificate is issued and, for the purposes of determining the nature and extent of any such obligation, the Contract shall be deemed to remain in force between the parties to the Contract.

Remedies

63.1 Default of Contractor

If the Contractor is deemed by law unable to pay his debts as they fall due, or enters into voluntary or involuntary bankruptcy, liquidation or dissolution (other than a voluntary liquidation for the purposes of amalgamation or reconstruction), or becomes insolvent, or makes an arrangement with, or assignment in favour of, his creditors, or agrees to carry out the Contract under a committee of inspection of his creditors, or



if a receiver, administrator, trustee or liquidator is appointed over any substantial part of his assets, or if, under any law or regulation relating to reorganization, arrangement or readjustment of debts, proceedings are commenced against the Contractor or resolutions passed in connection with dissolution or liquidation or if any steps are taken to enforce any security interest over a substantial part of the assets of the Contractor, or if any act is done or event occurs with respect to the Contractor or his assets which, under any applicable law has a substantially similar effect to any of the foregoing acts or events, or if the Contractor has contravened Sub-Clause 3.1, or has an execution levied on his goods, or Contract, if the Engineer certifies to the Employer, with a copy to the Contractor, that, in his opinion, the Contractor:

- (a) has repudiated the Contract, or
- (b) without reasonable excuse has failed
- (i) to commence the Works in accordance with Sub-Clause 41.1,
 - (ii) to proceed with the Works, or any Section thereof, within 28 days after receiving notice pursuant to Sub-Clause 46.1,
- (c) has failed to comply with a notice issued pursuant to Sub-Clause 37.4 or an instruction issued pursuant to Sub-Clause 39.1 within 28 days after having received it
- (d) despite previous warning from the Engineer, in writing, is otherwise persistently or flagrantly neglecting to comply with any of his obligations under the Contract, or
- (e) has contravened Sub-Clause 4.1,

then the Employer may, after giving 14 days' notice to the Contractor, enter upon the Site and the Works and terminate the employment of the Contractor without thereby releasing the Contractor from any of his obligations or liabilities under the Contract, or affecting the rights and authorities conferred on the Employer or the Engineer by the Contract, and may himself complete the Works or may employ any other contractor to complete the Works. The Employer or such other contractor may use for such completion so much of the Contractor's Equipment, Temporary Works and materials as he or they may think proper.

63.2 Valuation at Date of Termination

The Engineer shall, as soon as may be practicable after any such entry and termination by the Employer, fix and determine expert, or by or after reference to the parties or after such investigation or enquiries as he may think fit to make or institute, and shall certify:



- (a) what amount (if any) had, at the time of such entry and termination, been reasonably earned by or would reasonably accrue to the Contractor in respect of work then actually done by him under the Contract, and
- (b) the value of any of the said unused or partially used materials, any Contractor's Equipment and any Temporary Works.

63.3 Payment after Termination

If the Employer terminates the Contractor's employment under this Clause, he shall not be liable to pay to the Contractor any further amount (including damages) in respect of the Contract until the expiration of the Defects Liability Period and thereafter until the costs of execution, completion and remedying of any defects, damages for delay in completion (if any) and all other expenses incurred by the Employer have been ascertained and the amount thereof certified by the Engineer. The Contractor shall then be entitled to receive only such sum (if any) as the Engineer may certify would have been payable to him upon due completion by him after deducting the said amount. If such amount exceeds the sum which would have been payable to the Contractor on due completion by him, then the Contractor shall, upon demand, pay to the Employer the amount of such excess and it shall be deemed a debt due by the Contractor to the Employer and shall be recoverable accordingly.

63.4 Assignment of Benefit of Agreement

Unless prohibited by law, the Contractor shall, if so instructed by the Engineer within 14 days of such entry and termination referred to in Sub-Clause 63.1, assign to the Employer the benefit of any agreement for the supply of any goods or materials or services and/or for the execution of any work for the purposes of the Contract, which the Contractor may have entered into.

64.1 Urgent Remedial Work

If, by reason of any accident, or failure, or other event occurring to, in, or in connection with the Works, or any part thereof, either during the execution of the Works, or during the Defects Liability Period, any remedial or other work is, in the opinion of the Engineer, urgently necessary for the safety of the Works and the Contractor is unable or unwilling at once to do such work, the Employer shall be entitled to employ and pay other persons to carry out such work as the Engineer may consider necessary. If the work or repair so done by the Employer is work which, in the opinion of the Engineer, the Contractor was liable to do at his own cost under the Contract, then all costs consequent thereon



or incidental thereto shall, after due consultation with the Employer and the Contractor, be determined by the Engineer and shall be recoverable from the Contractor by the Employer, and may be deducted by the Employer from any monies due or to become due to the Contractor and the Engineer shall notify the Contractor accordingly, with a copy to the Employer. Provided that the Engineer shall, as soon after the occurrence of any such emergency as may be reasonably practicable, notify the Contractor thereof.

Special Risks

65.1 No Liability for Special Risks

Subject to due care and precaution and due diligence by the Contractor, the Contractor shall be under no liability whatsoever in consequence of any of the special risks referred to in Sub-Clause 65.2, whether by way of indemnity or otherwise, for or in respect of:

- (a) destruction of or damage to the Works, save to work condemned under the provisions of Clause 39 prior to the occurrence of any of the said special risks,
- (b) destruction of or damage to property, whether of the Employer or third parties, or
- (c) injury or loss of life.

65.2 Special Risks

The Special Risks are:

- (a) the risks defined under paragraphs (a), (c), (d) and (e) of Sub-Clause 20.4, and
- (b) the risks defined under paragraph (b) of Sub-Clause 20.4 insofar as these relate to the country in which the Works are to be executed.

65.3 Damage to Works by Special Risks

If the Works or any materials or Plant on or near or in transit to the Site, or any of the Contractor's Equipment, sustain destruction or damage by reason of any of the said special risks, the Contractor shall be entitled to payment in accordance with the Contract for any Permanent Works duly executed and for any materials or Plant so destroyed or damaged and, so far as may be required by the Engineer or as may be necessary for the completion of the Works, to payment for:

- (a) rectifying any such destruction or damage to the Works, and
- (b) replacing or rectifying such materials or Contractor's Equipment,



and the Engineer shall determine an addition to the Contract Price in accordance with Clause 52 (which shall in the case of the cost of replacement of Contractor's Equipment include the fair market value thereof as determined by the Engineer) and shall notify the Contractor accordingly, with a copy to the Employer.

65.4 Projectile, Missile

Destruction, damage, injury or loss of life caused by the explosion or impact, whenever and wherever occurring, of any mine, bomb, shell, grenade, or other projectile, missile, munitions, or explosive of war, shall be deemed to be a consequence of the said special risks.

65.5 Increased Costs arising from Special Risks

Save to the extent that the Contractor is entitled to payment under any other provision of the Contract, the Employer shall repay to the Contractor any costs of the execution of the Work (other than such as may be attributable to the cost of reconstructing work condemned under the provisions of Clause 39 prior to the occurrence of any special risk) which are howsoever attributable to or consequent on or the result of or in any way whatsoever connected with the said special risks, subject however to the provisions in this Clause hereinafter contained in regard to outbreak of war, but the Contractor shall, as soon as any such cost comes to his knowledge, forthwith notify the Engineer thereof. The Engineer shall, after due consultation with the Employer and the Contractor, determine the amount of the Contractor's costs in respect thereof which shall be added to the Contract Price and shall notify the Contractor accordingly, with a copy to the Employer.

65.6 Outbreak of War

If, during the currency of the Contract, there is an outbreak of war, whether war is declared or not, which, whether financially or otherwise, materially affects the execution of the Works, the Contractor shall, unless and until the Contract is terminated under the provisions of this Clause, continue to use his best endeavour to complete the execution of the Works. Provided that the Employer shall be entitled, at any time after such outbreak of war, to terminate the Contract by giving notice to the Contractor and, upon such notice being given, the Contract shall, except as to the rights of the parties under this clause and Clause 67, terminate, but without prejudice to the rights of either party in respect of any antecedent breach thereof.

65.7 Removal of Contractor's Equipment on Termination

If the Contract is terminated under the provisions of Sub-Clause 65.6, the Contractor shall, with all reasonable dispatch, remove from the Site all Contractor's Equipment and shall give similar facilities to his



Subcontractors to do so.

65.8 Payment if Contract Terminated

If the Contract is terminated as aforesaid, the Contractor shall be paid by the Employer, insofar as such amounts or items have not already been covered by payments on account made to the Contractor, for all work executed prior to the date of termination at the rates and prices provided in the Contract and in addition:

- (a) the amounts payable in respect of any preliminary items referred to in the Bill of Quantities, so far as the work or service comprised therein has been carried out or performed, and a proper portion of any such items which have been partially carried out or performed;
- (b) the cost of materials, Plant or goods reasonably ordered for the Works which have been delivered to the Contractor or of which the Contractor is legally liable to accept delivery, such materials, Plant or goods becoming the property of the Employer upon such payments being made by him;
- (c) a sum being the amount of any expenditure reasonably incurred by the Contractor in the expectation of completing the whole of the Works insofar as such expenditure has not been covered by any other payments referred to in this Sub-Clause;
- (d) any additional sum payable under the provisions of Sub-Clauses 65.3 and 65.5;
- (e) such proportion of the cost as may be reasonable, taking into account payments made or to be made for work executed, of removal of Contractor's Equipment under Sub-Clause 65.7 and, if required by the Contractor, return thereof to the Contractor's main plant yard in his country of registration or to other destination, at no greater cost; and
- (f) the reasonable cost of repatriation of all the Contractor's staff and workmen employed on or in connection with the Works at the time of such termination.

Provided that against any payment due from the Employer under this Sub-Clause, the Employer shall be entitled to be credited with any outstanding balances due from the Contractor for advances in respect of Contractor's Equipment, materials and Plant and any other sums which, at the date of termination, were recoverable by the Employer from the Contractor under the terms of Contract. Any sums payable under this Sub-Clause shall, after due consultation with the Employer and the Contractor, be determined by the Engineer who shall notify the Contractor accordingly,



with a copy to the Employer.

Release from Performance

66.1 Payment in Event of Release from Performance

If any circumstance outside the control of both parties arises after the issue of the Letter of Acceptance which renders it impossible or unlawful for either party to fulfill his or their contractual obligations, or under the law governing the Contract the parties are released from further performance, then the parties shall be discharged from the Contract, except as to their rights under this Clause and Clause 67 and without prejudice to the rights of either party in respect of any antecedent breach of the Contract, and the sum payable by the Employer to the Contractor in respect of the work executed shall be the same as that which would have been payable under Clause

65 if the Contract had been terminated under the provisions of Clause 65.

Settlement of Disputes

67.1 Employer's Decision

If a dispute of any kind whatsoever arises between the Employer and the Contractor in connection with, or arising out of, the Contract or the execution of the Works, whether during the execution of the Works or after their completion and whether before or after repudiation or other termination of the Contract, including any dispute as to any opinion, instruction, determination, certificate or valuation of the Engineer, the matter in dispute shall, in the first place, be referred not later than 30 days in writing to the MD/CEO of the Employer or his nominee, with a copy to the other party. Such reference shall state that it is made pursuant to this Clause. Not later than

30 days after the day on which he received such reference the MD/CEO or his nominee shall give notice of his decision to the Employer and the Contractor. Such decision shall state that it is made pursuant to this Clause.

Unless the Contract has already been repudiated or terminated, the Contractor shall, in every case, continue to proceed with the Works with all due diligence and the Contractor and the Employer shall give effect forthwith to every such decision of the MD/CEO or his nominee unless and until the same shall be revised, as hereinafter provided, in an amicable settlement or an arbitral award.

If either the Employer or the Contractor be dissatisfied with any decision of the MD/CEO or his nominee, or if the MD/CEO or his nominee fails to give notice of his decision on or before the 30 days on which he received the reference, then either the Employer or the



Contractor may, on or before the 30th day after the day on which he received notice of such decision, or on or before the 30th day after the day on which the said period of 30th days expired, as the case may be, give notice to the other party, with a copy for information to the Engineer & Employer, of his intention to commence arbitration, as hereinafter provided, as to the matter in dispute. Such notice shall establish the entitlement of the party giving the same to commence arbitration, as hereinafter provided, as to such dispute and, subject to Sub-Clause 67.4, no arbitration in respect thereof may be commenced unless such notice is given.

If the MD/CEO or his nominee as the case may be has given notice of his decision as to a matter in dispute to the Employer and the Contractor and no notice of intention to commence arbitration as to such dispute has been given by either the Employer or the Contractor on or before the 30th day after the day on which the parties received notice as to such decision, the said decision shall become final and binding upon the Employer and the Contractor.

67.2 Amicable Settlement

Where notice of intention to commence arbitration as to a dispute has been given in accordance with Sub-Clause 67.1, the parties shall attempt to settle such dispute amicably before the commencement of arbitration. Provided that, unless the parties otherwise agree, arbitration may be commenced on or after 30th day after the day on which notice of intention to commence arbitration of such dispute was given, even if no attempt at amicable settlement thereof has been made.

67.3 Arbitration

Any dispute in respect of which:

- (a) the decision, if any, of the MD/CEO or his nominee has not become final and binding pursuant to Sub-Clause 67.1, and
- (b) amicable settlement has not been reached within the period stated in Sub-Clause 67.2,

shall be finally settled, unless otherwise specified in the Contract, under the Arbitration Act, 1940. The said arbitrator/s shall have full power to open up, review and revise any decision, opinion, instruction, determination, certificate or valuation of the MD/CEO or his nominee related to the dispute.

Neither party shall be limited in the proceedings before such arbitrator/s to the evidence or arguments put before the MD/CEO or his nominee for the purpose of obtaining his said decision pursuant to Sub-Clause 67.1. No such decision shall disqualify the Engineer from



being called as a witness and giving evidence before the arbitrator/s on any matter whatsoever relevant to the dispute.

Arbitration may be commenced prior to or after completion of the Works, provided that the obligations of the Employer, the Engineer and the Contractor shall not be altered by reason of the arbitration being conducted during the progress of the Works.

67.4 Final and Binding Decision

Where neither the Employer nor the Contractor has given notice of intention to commence arbitration of a dispute within the period stated in Sub-Clause 67.1 and the related decision shall become final and binding.

Notice

68.1 Notices to Contractor

All certificates, notices or instructions to be given to the Contractor by the Employer or the Engineer under the terms of the Contract shall be sent by post, cable, telex or facsimile transmission to or left at the Contractor's principal place of business or such other address as the Contractor shall nominate for that purpose.

68.2 Notice to Employer and Engineer

Any notice to be given to the Employer or to the Engineer under the terms of the Contract shall be sent by post, cable, telex or facsimile transmission to or left at the respective addresses nominated for that purpose in Part II of these Conditions.

68.3 Change of Address

Either party may change a nominated address to another address in the country where the Works are being executed by prior notice to the other party, with a copy to the Engineer, and the Engineer may do so by prior notice to both parties.

Default of Employer

69.1 Default of Employer

In the event of the Employer:

- (a) failing to pay to the Contractor the amount due under any certificate of the Engineer within 28 days after the expiry of the time stated in Sub-Clause 60.10 Within which payment is to be made, subject to any deduction that the Employer is entitled to make under the Contract,



- (b) interfering with or obstructing or refusing any required approval to the issue of any such certificate,
- (c) becoming bankrupt or, being a company, going into liquidation, other than for the purpose of a scheme of reconstruction or amalgamation, or
- (d) giving notice to the Contractor that for economic reasons it is impossible for him to continue to meet his contractual obligations, the Contractor shall be entitled to terminate his employment under the Contract by giving notice to the Employer, with a copy to the Engineer. Such termination shall take effect 14 days after the giving of the notice.

69.2 Removal of Contractor's Equipment

Upon the expiry of the 14 days' notice referred to in Sub-Clause 69.1, the Contractor shall, notwithstanding the provisions of Sub-Clause 54.1, with all reasonable dispatch, remove from the Site all Contractor's Equipment brought by him thereon.

69.3 Payment on Termination

In the event of such termination the Employer shall be under the same obligations to the Contractor in regard to payment as if the Contract had been terminated under the provisions of Clause 65.

69.4 Contractor's Entitlement to Suspend Work

Without prejudice to the Contractor's entitlement to interest under Sub-Clause 60.10 and to terminate under Sub-Clause 69.1, the Contractor may, if the Employer fails to pay the Contractor the amount due under any certificate of the Engineer within 28 days after the expiry of the time stated in Sub-Clause 60.10 within which payment is to be made, subject to any deduction that the Employer is entitled to make under the Contract, after giving 28 days' prior notice to the Employer, with a copy to the Engineer, suspend work or reduce the rate of work.

If the Contractor suspends work or reduces the rate of work in accordance with the provisions of this Sub-Clause and thereby suffers delay or incurs costs the Engineer shall, after due consultation with the Employer and the Contractor, determine:

- (a) any extension of time to which the Contractor is entitled under Clause 44, and
- (b) the amount of such costs, which shall be added to the Contract Price, and

shall notify the Contractor accordingly, with a copy to the Employer.

**69.5 Resumption of Work**

Where the Contractor suspends work or reduces the rate of work, having given notice in accordance with Sub-Clause 69.4, and the Employer subsequently pays the amount due, including interest pursuant to Sub-Clause 60.10, the Contractor's entitlement under Sub-Clause 69.1 shall, if notice of termination has not been given, lapse and the Contractor shall resume normal working as soon as is reasonably possible.

Changes in Cost and Legislation**70.1 Increase or Decrease of Cost (Clause-70 is deleted entirely).**

There shall be added to or deducted from the Contract Price such sums in respect of rise or fall in the cost of labour and/or materials or any other matters affecting the cost of the execution of the Works as may be determined in accordance with part II of these Conditions.

70.2 Subsequent Legislation

If, after the date 28 days prior to the latest date for submission of tenders for the Contract there occur in the country in which the Works are being or are to be executed changes to any National or State Statute, Ordinance, Decree or other Law or any regulation or bye-law of any local or other duly constituted authority, or the introduction of any such State Statute, Ordinance, Decree, Law, regulation or bye-law which causes additional or reduced cost to the Contractor, other than under Sub-Clause 70.1, in the execution of the Contract, such additional or reduced cost shall, after due consultation with the Employer and the Contractor, be determined by the Engineer and shall be added to or deducted from the Contract Price and the Engineer shall notify the Contractor accordingly, with a copy to the Employer.

Currency and Rates of Exchange**71.1 Currency Restrictions**

If, after the date 28 days prior to the latest date for submission of tenders for the Contract, the Government or authorized agency of the Government of the country in which the Works are being or are to be executed imposes currency restrictions and/or transfer of currency restrictions in relation to the currency or currencies in which the Contract Price is to be paid, the Employer shall reimburse any loss or damage to the Contractor arising therefrom, without prejudice to the right of the Contractor to exercise any other rights or remedies to which he is entitled in such event.

**72.1 Rates of Exchange**

Where the Contract provides for payment in whole or in part to be made to the Contractor in foreign currency or currencies, such payment shall not be subject to variations in the rate or rates of exchange between such specified foreign currency or currencies and the currency of the country in which the Works are to be executed.

72.2 Currency Proportions

Where the Employer has required the Tender to be expressed in a single currency but with payment to be made in more than one currency and the Contractor has stated the proportions or amounts of other currency or currencies in which he requires payment to be made, the rate or rates of exchange applicable for calculating the payment of such proportions or amounts shall, unless otherwise stated in Part II of these Conditions, be those prevailing, as determined by the Central Bank of the country in which the Works are to be executed, on the date 28 days prior to the latest date for the submission of tenders for the Contract, as has been notified to the Contractor by the Employer prior to the submission of tenders or as provided for in the Tender.

72.3 Currencies of Payment for Provisional Sums

Where the Contract provides for payment in more than one currency, the proportions or amounts to be paid in foreign currencies in respect of Provisional Sums shall be determined in accordance with the principles set forth in Sub-Clauses 72.1 and 72.2 as and when these sums are utilised in whole or in part in accordance with the provisions of Clauses 58 and 59.



PART – II
PARTICULAR CONDITIONS OF CONTRACT



PART II
PARTICULAR CONDITIONS OF CONTRACT
(Mandatory Provisions not to be Amended / Substituted except as instructed by PEC)

1.1 Definitions

- (a) (i) The Employer is Oil & Gas Development Company Limited (OGDCL), Islamabad, its legal successors and assignees.
- (a) (iv) The Engineer is the person / consultant appointed, from time to time, by the Employer or any other competent person appointed by the Employer, and notified to the Contractor, to act in replacement of the Engineer. Provided always that except in cases of professional misconduct, the outgoing Engineers is to formulate his certifications/recommendations in relation to all outstanding matters, disputes and claims relating to the execution of the Works during his tenure.

The following paragraph is added:

- (a)(vi) “Bidder or Tendered” means any person or persons, company, corporation, firm or joint venture submitting a Bid or Tender.
- (b)(v) The following is added at the end of the paragraph:

The word “Tender” is synonymous with “Bid” and the word “Tender Documents” with “Bidding Documents”.

The following paragraph is added:

- (b)(ix) “Programme” means the programme to be submitted by the Contractor in accordance with Sub-Clause 14.1 and any approved revisions thereto.
- (e)(i) The text is deleted and substituted with the following:

“Contract Price” means the sum stated in the Letter of Acceptance as payable to the Contractor for the execution and completion of the Works subject to such additions thereto or deductions there from as may be made and remedying of any defects therein in accordance with the provisions of the Contract.

2.1 Engineer's Duties and Authority

With reference to Sub-Clause 2.1(b), the following provisions shall also apply;



The Engineer shall obtain the specific approval of the Employer before carrying out his duties in accordance with the following Clauses:

- (i) Consenting to the sub-letting of any part of the Works under Sub-Clause 4.1 “Subcontracting”.
- (ii) Certifying additional cost determined under Sub-Clause 12.2 “Not Foreseeable Physical Obstructions or Conditions”.
- (iii) Any action under Clause 10 “Performance Security” and Clauses 21,23,24 & 25 “Insurance” of sorts.
- (iv) Any action under Clause 40 “Suspension”.
- (v) Any action under Clause 44 “Extension of Time for Completion”.
- (vi) Any action under Clause 47 “Liquidated Damages for Delay”
- (vii) Issuance of “Taking Over Certificate” under Clause
- 48. (viii) Issuing a Variation Order under Clause 51,except:
 - a) in an emergency* situation, as stated here below, or
 - b) if such variation would increase the Contract Price by less than the amount stated in the Appendix-A to Bid.
- (ix) Fixing rates or prices under Clause 52.
- (x) Extra payment as a result of Contractor’s claims under Clause 53.
- (xi) Release of Retention Money to the Contractor under Sub-Clause 60.3 “Payment of Retention Money”.
- (xii) Issuance of “Final Payment Certificate” under Sub-Clause 60.8.
- (xiii) Issuance of “Defect Liability Certificate” under Sub-Clause 62.1.
- (xiv) Any change in the ratios of Contract currency proportions and payments thereof under Clause 72 “Currency and Rate of Exchange”.

(Note: Employer may further vary according to need of the project)



* (If in the opinion of the Engineer an emergency occurs affecting the safety of life or of the Works or of adjoining property, the Engineer may, without relieving the Contractor of any of his duties and responsibilities under the Contract, instruct the Contractor to execute all such work or to do all such things as may, in the opinion of the Engineer, be necessary to abate or reduce the risk. The Contractor shall forthwith comply with any such instruction of the Engineer. The Engineer shall determine an addition to the Contract Price, in respect of such instruction, in accordance with Clause 52 and shall notify the Contractor accordingly, with a copy to the Employer.)

2.2 Engineer's Representative

The following paragraph is added:

The Employer shall ensure that the Engineer's Representative is a professional engineer as defined in the Pakistan Engineering Council Act 1975 (V of 1976)

The following Sub-Clauses 2.7 and 2.8 are added:

2.7 Engineer Not Liable

Approval, reviews and inspection by the Engineer of any part of the Works does not relieve the Contractor from his sole responsibility and liability for the supply of materials, plant and equipment for construction of the Works and their parts in accordance with the Contract and neither the Engineer's authority to act nor any decision made by him in good faith as provided for under the Contract whether to exercise or not to exercise such authority shall give rise to any duty or responsibility of the Engineer to the Contractor, any Subcontractor, any of their representatives or employees or any other person performing any portion of the Works.

2.8 Replacement of the Engineer

“If the Employer intends to replace the Engineer, the Employer shall, not less than 14 days before the intended date of replacement, give notice to the Contractor, of the name, address and relevant experience of the intended replacement Engineer. The Employer shall not replace the Engineer with a person against whom the Contractor raises reasonable objection by notice to the Employer, with supporting particulars.”



5.1 Language(s) and Law

- (a) The Contract Documents shall be drawn up in the English language.
- (b) The Contract shall be subject to the Laws of Islamic Republic of Pakistan.

5.2 Priority of Contract Documents

In case of discrepancies between drawings, those of larger scale shall govern unless they are superseded by a drawing of later date regardless of scale. All Drawings and Specifications shall be interpreted in conformity with the Contract and these Conditions. Addendum, if any, shall be deemed to have been incorporated at the appropriate places in the documents forming the Contract.

The following Sub-Clauses 6.6 and 6.7 are added:

6.6 Shop Drawings

The Contractor shall submit to the Engineer for review 3 copies of all shop and erection drawings applicable to this Contract as per provision of relevant Sub-Clause of the Contract.

Review and approval by the Engineer shall not be construed as a complete check but will indicate only that the general method of construction and detailing is satisfactory and that the Engineer's review or approval shall not relieve the Contractor of any of his responsibilities under the Contract.



6.7 As-Built Drawings

At the completion of the Works under the Contract, the Contractor shall furnish to the Engineer 6 copies and one reproducible of all drawings amended to conform with the Works as built. The price of such Drawings shall be deemed to be included in the Contract Price.

10.1 Performance Security

The text is deleted and substituted with the following:

The Contractor shall provide Performance Security to the Employer in the prescribed form as per Employer Format. The said Security shall be furnished or caused to be furnished by the Contractor within 14 days or the time stipulated by the Employer after the receipt of the Letter of Acceptance. The maximum amount of Performance Security shall be equal to 10% of the total Contract Price stated in the Letter of Acceptance. Such Security shall be in the form of bank guarantee from any Scheduled Bank in Pakistan.

The cost of complying with requirements of this Sub-Clause shall be borne by the Contractor

The following Sub-Clause 10.4 is added:

10.4 Performance Security Binding on Variations and Changes

The Performance Security shall be binding irrespective of changes in the quantities or variations in the Works or extensions in Time for Completion of the Works which are granted or agreed upon under the provisions of the Contract.

14.1 Programme to be submitted

The programme shall be submitted within 42 days from the date of receipt of Letter of Acceptance, which shall be in the form of:

- i) a Bar Chart identifying the critical activities.
- ii) a CPM identifying the critical path/activities.
(Employer to select appropriate one)



14.3 Cash Flow Estimate to be Submitted

The detailed Cash Flow Estimate shall be submitted within 21 days from the date of receipt of Letter of Acceptance

The following Sub-Clause 14.5 is added:

14.5 Detailed Programme and Monthly Progress Report

- a) For purposes of Sub-Clause 14.1, the Contractor shall submit to the Engineer detailed programme for the following:
 - (1) Execution of Works; (2) Labour Employment;
 - (3) Local Material Procurement; (4) Material Imports, if any; and
 - (5) Other details as required by the Engineer.

- (b) During the period of the Contract, the Contractor shall submit to the Engineer not later than the 8th day of the following month, 10 copies each of Monthly Progress Reports covering:
 - (1) A Construction Schedule indicating the monthly progress in percentage;
 - (2) Description of all work carried out since the last report;
 - (3) Description of the work planned for the next 56 days sufficiently detailed to enable the Engineer to determine his programme of inspection and testing;
 - (4) Monthly summary of daily job record;
 - (5) Photographs to illustrate progress ;and
 - (6) Information about problems and difficulties encountered, if any, and proposals to overcome the same.

- (c) During the period of the Contract, the Contractor shall keep a daily record of the work progress, which shall be made available to the Engineer as and when requested. The daily record shall include particulars of weather conditions, number of men working, deliveries of materials, quantity, location and assignment of Contractor's equipment.

The following Sub-Clauses 15.2 and 15.3 are added:

15.2 Language Ability of Contractor's Representative

The Contractor's authorized representative shall be fluent in the English language. Alternately an interpreter with ability of English language shall be provided by the Contractor on full time basis.



15.3 Contractor's Representative

The Contractor's authorized representative and his other professional engineers working at Site shall register themselves with the Pakistan Engineering Council.

The Contractor's authorized representative at Site shall be authorized to exercise adequate administrative and financial powers on behalf of the Contractor so as to achieve completion of the Works as per the Contract.

The following Sub-Clauses 16.3 and 16.4 are added:

16.3 Language Ability of Superintending Staff of Contractor

A reasonable proportion of the Contractor's superintending staff shall have a working knowledge of the English language. If the Contractor's superintending staff are not fluent in English language, the Contractor shall make competent interpreters available during all working hours in a number deemed sufficient by the Engineer.

16.4 Employment of Local Personnel

The Contractor is encouraged, to the extent practicable and reasonable, to employ staff and labour from sources within Pakistan.

The following Sub-Clauses 19.3 and 19.4 are added:

19.3 Safety Precautions

In order to provide for the safety, health and welfare of persons, and for prevention of damage of any kind, all operations for the purposes of or in connection with the Contract shall be carried out in compliance with the Safety Requirements of the Government of Pakistan with such modifications thereto as the Engineer may authorize or direct and the Contractor shall take or cause to be taken such further measures and comply with such further requirements as the Engineer may determine to be reasonably necessary for such purpose.

The Contractor shall make, maintain and submit reports to the Engineer concerning safety, health and welfare of persons and damage to property, as the Engineer may from time to time prescribe.



19.4 Lighting Work at Night

In the event of work being carried out at night, the Contractor shall at his own cost, provide and maintain such good and sufficient light as will enable the work to proceed satisfactorily and without danger. The approaches to the Site and the Works where the night-work is being carried out shall be sufficiently lighted. All arrangement adopted for such lighting shall be to the satisfaction of the Engineer's Representative.

20.4 Employer's Risks

The Employer's risks are:

Notwithstanding anything contained (in GCC 20.4), the Employer shall not be responsible, compensate or bear any kind of risk/liability whatsoever in nature.

21.1 Insurance of Works and Contractor's Equipment

Insurance will be the liability of the Contractor in any of the case.

21.3 Responsibility for Amounts not Recovered

The text is deleted and substituted with the following:

Any amount not insured or not recovered from the insurers shall be borne by the Contractor in accordance with their responsibility.

21.4 Exclusions

The text is deleted and substituted with the following:

There shall be no obligation for the insurances in Sub-Clause 21.1 to include loss or damage caused by the risks listed under Sub-Clause 20.4 paras (a) to (h).

The following Sub-Clause 25.5 is added.

21.5 Taxes

Any taxes, duties, fees, levies and other relevant charges, present or future, assessed or payable outside Pakistan by the Contractor and/or by the expatriate



personnel deputed by Contractor in connection with the services performed under the contract shall be the exclusive responsibility of the Contractor.

Any taxes, duties, fees, levies and other relevant charges, present or future, assessed or payable in Pakistan by the Contractor and/or by the expatriate personnel deputed by the Contractor in connection with the services performed under the contract shall be the exclusive responsibility of the Contractor.

The Contractor shall be responsible and pay all taxes on its income outside and in particular on its income in Pakistan under the Contract and under the laws of Pakistan. Employer shall have the right, as provided under the laws of Pakistan to meet its obligations and in particular to deduct from the payment due to the Contractor, income tax at source at the rates prevailing from time to time, from the invoiced amounts, or such reduced rates fixed by the taxation authorities for the Contractor on production of documentary evidence by the Contractor and pay such amount to appropriate authorities.

The Contractor shall also be responsible for any income taxes levied on the Contractor's expatriate personnel, under the laws of Pakistan and for all social security issuances and other contributions for the Contractor's expatriate personnel regardless of whether such contributions are levied on employer or employee or both in Pakistan.

The Contractor shall keep Employer duly informed about the steps taken by the Contractor in order to meet its obligations under the contract and provide the necessary documents to Employer in this connection.

The Contractor shall indemnify Employer against any claim, which might occur due to non-compliance by the Contractor of any legal obligation regarding the taxes, duties, fees, levies, or other charges, including taxes on income in Pakistan and any other payments to the Government or Governmental agencies.

22.2 Exceptions

The sub clause 22.2(d) is deleted.

22.3 Indemnity by the Employer

The clause is deleted in its entirety.

23.1 Third Party Insurance (Including Employer's Property)

The clause will be read as follows:



The Contractor shall, without limiting his or the Employer's obligation and responsibilities under Clause 22, insure, in the joint names of the Contractor and the Employer, against liabilities for death of or injury to any person.

25.1 Evidence and Terms of Insurances

Number of days in the text of this clause shall be read as 30 days instead of 84 days.

25.3 Remedy on Contractor Failure to Insure

Delete the text and substitute with the following

The Contractor shall effect and keep in force all insurances required under the contract. The Employer shall not effect any kind of insurance on behalf of this project.

25.4 Compliance with Policy Conditions

Delete the text and substitute with the following:

“In the event that the Contractor fails to comply with conditions imposed by the insurance policies effected pursuant to the contract, the Contractor shall indemnify the other against all losses and claims arising from such failure.”

25.5 Insurance Company

The Contractor shall be obliged to place all insurances relating to the Contract (including, but not limited to, the insurances referred to in Clauses 21, 23 and 24) with either National Insurance Company of Pakistan or any other insurance company operating in Pakistan and acceptable to the Employer.

Costs of such insurances shall be borne by the Contractor. The following Sub-

Clause 31.3 is added:

31.3 Co-operation with other Contractors

During the execution of the Works, the Contractor shall co-operate fully with other contractors working for the Employer at and in the vicinity of the Site and also shall provide adequate precautionary facilities not to make himself a nuisance to local residents and other contractors.



The following Sub-Clauses 34.2 to 34.12 are added:

34.2 Rates of Wages and Conditions of Labour

The Contractor shall pay rates of wages and observe conditions of labour not less favorable than those established for the trade or industry where the work is carried out. In the absence of any rates of wages or conditions of labour so established, the Contractor shall pay rates of wages and observe conditions of labour which are not less favorable than the general level of wages and conditions observed by other employers whose general circumstances in the trade or in industry in which the Contractor is engaged are similar.

34.3 Employment of Persons in the Service of Others

The Contractor shall not recruit his staff and labour from amongst the persons in the services of the Employer or the Engineer; except with the prior written consent of the Employer or the Engineer, as the case may be.

34.4 Housing for Labour

Save insofar as the Contract otherwise provides, the Contractor shall provide and maintain such housing accommodation and amenities as he may consider necessary for all his supervisory staff and labour, employed for the purposes of or in connection with the Contract including all fencing, electricity supply, sanitation, cookhouses, fire prevention, water supply and other requirements in connection with such housing accommodation or amenities. On completion of the Contract, these facilities shall be handed over to the Employer or if the Employer so desires, the temporary camps or housing provided by the Contractor shall be removed and the Site reinstated to its original condition, all to the approval of the Engineer.

34.5 Health and Safety

Due precautions shall be taken by the Contractor, and at his own cost, to ensure the safety of his staff and labour at all times throughout the period of the Contract. The Contractor shall further ensure that suitable arrangements are made for the prevention of epidemics and for all necessary welfare and hygiene requirements.

34.6 Epidemics

In the event of any outbreak of illness of an epidemic nature, the Contractor shall comply with and carry out such regulations, orders and requirements as



may be made by the Government, or the local medical or sanitary authorities, for purpose of dealing with and overcoming the same.

34.7 Supply of Water

The Contractor shall, so far as is reasonably practicable, having regard to local conditions, provide on the Site, to the satisfaction of the Engineer or his representative, adequate supply of drinking and other water for the use of his staff and labour.

34.8 Alcoholic Liquor or Drugs

The Contractor shall not, otherwise than in accordance with the Statutes, Ordinances and Government Regulations or Orders for the time being in force, import, sell, give, barter or otherwise dispose of any alcoholic liquor or drugs, or permit or suffer any such importation, sale, gift, barter or disposal by his Subcontractors, agents, staff or labour.

34.9 Arms and Ammunition

The Contractor shall not give, or otherwise dispose of to any person or persons, any arms or ammunition of any kind or permit or suffer the same as aforesaid.

34.10 Festivals and Religious Customs

The Contractor shall in all dealings with his staff and labour have due regard to all recognized festivals, days of rest and religious and other customs.

34.11 Disorderly Conduct

The Contractor shall at all times take all reasonable precautions to prevent any unlawful, riotous or disorderly conduct by or amongst staff and labour and for the preservation of peace and protection of persons and property in the neighborhood of the Works against the same.

34.12 Compliance by Subcontractors

The Contractor shall be responsible for compliance by his Subcontractors of the provisions of this Clause.

The following Sub-Clauses 35.2 and 35.3 are added:

35.2 Records of Safety and Health



The Contractor shall maintain such records and make such reports concerning safety, health and welfare of persons and damage to property as the Engineer may from time to time prescribe.

35.3 Reporting of Accidents

The Contractor shall report to the Engineer details of any accident as soon as possible after its occurrence. In the case of any fatality or serious accident, the Contractor shall, in addition, notify the Engineer immediately by the quickest available means.

The following Sub-Clause 36.6 is added:

36.6 Use of Pakistani Materials and Services

The Contractor shall, so far as may be consistent with the Contract, make the maximum use of materials, supplies, plant and equipment indigenous to or produced or fabricated in Pakistan and services, available in Pakistan provided such materials, supplies, plant, equipment and services shall be of required standard.

41.1 Commencement of Works

The text is deleted and substituted with the following:

The Contractor shall commence the Works on Site within the period named in Appendix-A to Bid from the date of receipt by him from the Engineer of a written Notice to Commence. Thereafter, the Contractor shall proceed with the Works with due expedition and without delay.

48.2 Taking Over of Sections or Parts

For the purposes of para (a) of this Sub-Clause, separate Times for Completion shall be provided in the Appendix-A to Bid "Special Stipulations". See attached samples for "Final Acceptance Certificate" (Attachment-I) and "Provisional Acceptance Certificate" (Attachment-II).

49.5 Extensions of Defects Liability Period

The provisions of this Sub-Clause shall apply to all replacements or renewals of plant and equipment carried out by the Contractor to remedy defects and damage as if the replacements and renewals had been taken over on the date they were completed. The Defects Liability Period for the Works shall be extended by a period equal to the period during which the Works cannot be used by reason of a defect or damage. If only a part of the Works is affected the Defects Liability Period shall be extended only for that part. In neither case shall



the Defects Liability Period extend beyond two (2) years from the date of taking over.

51.2 Instructions for Variations

At the end of the first sentence, after the word "Engineer", the words "in writing" are added.

52.1 Valuation of Variations

In the tenth line, after the words "Engineer shall" the following is added: within a period not exceeding one-eighth of the completion time subject to a minimum of 56 days from the date of disagreement whichever is later.

53.4 Failure to Comply

This Sub-Clause is deleted in its entirety.

54.3 Customs Clearance

(Employer may vary this Sub-Clause)

54.5 Conditions of Hire of Contractor's Equipment

The following paragraph is added:

The Contractor shall, upon request by the Engineer at any time in relation to any item of hired Contractor's Equipment, forthwith notify the Engineer in writing the name and address of the Owner of the equipment and shall certify that the agreement for the hire thereof contains a provision in accordance with the requirements set forth above.

The following Sub-Clauses 59.4 & 59.5 are added:

59.4 Payments to Nominated Subcontractors

The Contractor shall pay to the nominated Subcontractor the amounts which the Engineer certifies to be due in accordance with the subcontract. These amounts plus other charges shall be included in the Contract Price in accordance with Clause 58 [Provisional Sums], except as stated in Sub-Clause 59.5 [Certification of Payments].

59.5 Certification of Payments & Nominated Subcontractors

Before issuing a Payment Certificate which includes an amount payable



to a nominated Subcontractor, the Engineer may request the Contractor to supply reasonable evidence that the nominated Subcontractor has received all amounts due in accordance with previous Payment Certificates, less applicable deductions for retention or otherwise. Unless the Contractor:

- a) Submits reasonable evidence to the Engineer, or
- b)
 - i) satisfies the Engineer in writing that the Contractor is reasonably entitled to withhold or refuse to pay these amounts, and
 - ii) Submits to the Engineer reasonable evidence that the nominated Subcontractor has been notified of the Contractor's entitlement,

then the Employer may (at his sole discretion) pay direct to the nominated Subcontractor, part or all of such amounts previously certified (less applicable deductions) as are due to the nominated Subcontractor and for which the Contractor has failed to submit the evidence described in sub- paragraphs (a) or (b) above. The Contractor shall then repay, to the Employer, the amount which the nominated Subcontractor was directly paid by the Employer.

60.1 Monthly Statements

In the first line after the word "shall", the following is added:

"on the basis of the joint measurement of work done under Clause 56.1,"

In Para (c) the words "the Appendix to Tender" are deleted and substituted with the words "Sub-Clause 60.11 (a)(6) hereof".
(in case Clause 60.11 is applicable)

60.2 Monthly Payments

In the first line, "28" is substituted by "14". The following Sub-Clause 60.11 is added:

60.11 Secured Advance on Materials

- a) The Contractor shall be entitled to receive from the Employer Secured Advance against an indemnity bond acceptable to the Employer of such sum as the Engineer may consider proper in respect of non- perishable materials brought at the Site but not yet incorporated in the Permanent Works provided that:
 - (1) The materials are in accordance with the Specifications for



the Permanent Works;

- (2) Such materials have been delivered to the Site and are properly stored and protected against loss or damage or deterioration to the satisfaction of the Engineer but at the risk and cost of the Contractor;
 - (3) The Contractor's records of the requirements, orders, receipts and use of materials are kept in a form approved by the Engineer, and such records shall be available for inspection by the Engineer;
 - (4) The Contractor shall submit with his monthly statement the estimated value of the materials on Site together with such documents as may be required by the Engineer for the purpose of valuation of materials and providing evidence of ownership and payment therefore;
 - (5) Ownership of such materials shall be deemed to vest in the Employer and these materials shall not be removed from the Site or otherwise disposed of without written permission of the Employer; and
 - (6) The sum payable for such materials on Site shall not exceed 75 % of the (i) landed cost of imported materials, or (ii) ex-factory / ex-warehouse price of locally manufactured or produced materials, or (iii) market price of other materials.
- (b) The recovery of Secured Advance paid to the Contractor under the above provisions shall be effected from the monthly payments on actual consumption basis.

60.12 Financial Assistance to Contractor

Financial assistance shall be made available to the Contractor by the Employer by adopting any one of the following three Alternatives:

Alternative One: Mobilization Advance

- (a) An interest-free Mobilization Advance up to 10 % of the Contract Price stated in the Letter of Acceptance shall be paid by the Employer to the Contractor in two equal parts upon submission by the Contractor of a Mobilization Advance Guarantee for the full amount of the Advance in the specified form from a Scheduled Bank in Pakistan.



- (1) First part within 14 days after signing of the Contract Agreement or date of receipt of Engineer's Notice to Commence, whichever is earlier; and
 - (2) Second part within 42 days from the date of payment of the first part, subject to the satisfaction of the Engineer as to the state of mobilization of the Contractor.
- (b) This Advance shall be recovered in six equal installments.

63.1 Default of Contractor

The following para is added at the end of the Sub-Clause:

Provided further that in addition to the action taken by the Employer against the Contractor under this Clause, the Employer may also refer the case of default of the Contractor to Pakistan Engineering Council for punitive action under the Construction and Operation of Engineering Works Bye-Laws 1987, as amended from time to time.

65.2 Special Risks

The text is deleted and substituted with the following:

The Special Risks are the risks defined under Sub-Clause 20.4 sub paragraphs (a) to (h).

67.3 Arbitration

In the sixth to eight lines, the words "shall be finally settled appointed under such Rules" are deleted and substituted with the following:

shall be finally settled under the provisions of the Arbitration Act, 1940 as amended or any statutory modification or re-enactment thereof for the time being in force.

The following paragraph is added:

The place of arbitration shall be Islamabad, Pakistan.

68.1 Notice to Contractor

The following paragraph is added:

For the purposes of this Sub-Clause, the Contractor shall, immediately after



receipt of Letter of Acceptance, intimate in writing to the Employer and the Engineer by registered post, the address of his principal place of business or any change in such address during the period of the Contract.

68.2 Notice to Employer and Engineer

For the purposes of this Sub-Clause, the respective address are:

- a) The Employer:
OIL & GAS DEVELOPMENT COMPANY LIMITED, ISLAMABAD
- b) The Engineer:
The person appointed from time to time by the Employer.

70.1 Increase or Decrease of Cost

Sub-Clause 70.1 is deleted in its entirety

(a) Other Changes in Cost

To the extent that full compensation for any rise or fall in costs to the Contractor is not covered by the provisions of this or other Clauses in the Contract, the unit rates and prices included in the Contract shall be deemed to include amounts to cover the contingency of such other rise or fall of costs.

73.1 Payment of Income Tax

The Contractor, Subcontractors and their employees shall be responsible for payment of all their income tax, super tax and other taxes on income arising out of the Contract and the rates and prices stated in the Contract shall be deemed to cover all such taxes.

73.2 Customs Duty & Taxes

(Employer may incorporate provisions where applicable)

74.1 Integrity Pact

If the Contractor or any of his Subcontractors, agents or servants is found to have violated or involved in violation of the Integrity Pact signed by the Contractor as Appendix-L to his Bid, then the Employer shall be entitled to:

- (a) recover from the Contractor an amount equivalent to ten times the sum of any commission, gratification, bribe, finder's fee or kickback



- given by the Contractor or any of his Subcontractors, agents or servants;
- (b) terminate the Contract; and
 - (c) recover from the Contractor any loss or damage to the Employer as a result of such termination or of any other corrupt business practices of the Contractor or any of his Subcontractors, agents or servants.

The termination under Sub-Para (b) of this Sub-Clause shall proceed in the manner prescribed under Sub-Clauses 63.1 to 63.4 and the payment under Sub-Clause 63.3 shall be made after having deducted the amounts due to the Employer under Sub-Para (a) and (c) of this Sub-Clause.

75.1 Termination of Contract for Employer's Convenience

The Employer shall be entitled to terminate the Contract at any time for the Employer's convenience after giving 30 days prior notice to the Contractor, with a copy to the Engineer. In the event of such termination, the Contractor:

- (a) shall proceed as provided in Sub-Clause 65.7 hereof; and
- (b) shall be paid by the Employer as provided in Sub-Clause 65.8 hereof.

76.1 Liability of Contractor

The Contractor or his Subcontractors or assigns shall follow strictly, all relevant labour laws including the Workmen's Compensation Act and the Employer shall be fully indemnified for all claims, damages etc. arising out of any dispute between the Contractor, his Subcontractors or assigns and the labour employed by them.

77.1 Joint and Several Liability

If the Contractor is a joint venture of two or more persons, all such persons shall be jointly and severally bound to the Employer for the fulfillment of the terms of the Contract and shall designate one of such persons to act as leader with authority to bind the joint venture. The composition or the constitution of the joint venture shall not be altered without the prior consent of the Employer.

78.1 Details to be Confidential

The Contractor shall treat the details of the Contract as private and confidential, save in so far as may be necessary for the purposes thereof, and shall not publish or disclose the same or any particulars thereof in any trade or technical paper or elsewhere without the prior consent in writing of the



PANDHI & BALOCH#1

Employer or the Engineer. If any dispute arises as to the necessity of any publication or disclosure for the purpose of the Contract, the same shall be referred to the decision of the Engineer whose award shall be final.



OIL & GAS DEVELOPMENT COMPANY LTD

SCOPE OF WORK

FOR

**LAYING OF PIPELINES FROM
PANDHI#1 TO BALOCH#1 TO SINJHORO PLANT
(APPROX 37 KM's)**

TABLE OF CONTENTS

1.0	INTRODUCTION	2
2.0	PROJECT OBJECTIVE	2
3.0	DEFINATION	2
4.0	SCOPE OF WORK (GENERAL)	3
5.0	SCOPE	7
6.0	REFERENCE CODES, STANDARDS AND SPECIFICATIONS	7
7.0	HANDLING, HAULING, STRINGING AND STORING OF MATERIALS	8
8.0	BENDING.....	9
9.0	LINING UP.....	111
10.0	WELDING OF PIPELINE	122
11.0	FIELD JOINT COATING	122
12.0	LAYING	122
13.0	PIPELINE TIE-IN	144
14.0	CROSSINGS.....	155
15.0	INSTALLATION OF INSULATING JOINTS.....	155
16.0	WORKING SPREAD LIMITATIONS	155
17.0	CLEAN-UP & RESTORATION OF RIGHT-OF-WAY	155
18.0	INSPECTION OF SITE.....	166
19.0	MOBILIZATION / DEMOBILIZATION.....	166
20.0	QUALITY ASSURANCE AND QUALITY CONTROL.....	177
21.0	INSPECTION, TESTING AND PRE-COMMISSIONING.....	19
22.0	MECHANICAL COMPLETION	200
23.0	MECHANICAL COMPLETION CERTIFICATE.....	200
24.0	PRE – COMMISSIONING ACTIVITIES.....	211
25.0	COMMISSIONING.....	222
26.0	CONSTRUCTION COMPLETION	244



1.0 INTRODUCTION

Oil & Gas Development Co. Ltd. (OGDCL), hereinafter referred as Company, is interested in hiring the services of construction contractors for the development of Sinjhor field.

All associated Engineering and Survey works already stands conducted and now project is in the advance stage of implementation. The intent of this document is to outline the scope of services required from perspective Bidders.

2.0 PROJECT OBJECTIVE

The objective of this Project is to develop the field by installing the flow lines from Well to Sinjhor Plant.

3.0 DEFINATION

Company / Owner: Oil & Gas Development Co. Ltd. (OGDCL).

Contractor: "Contractor" means the person or persons, firm or Proprietor whose proposal has been accepted by the Company for construction, commissioning, performance testing and includes the Contractor's representative(s), successors and permitted assignees.

Vendor/Supplier: The organization, firm or agency order for the supply of equipment and or material has been placed.



4.0 SCOPE OF WORK (GENERAL)

Contractor's scope of work shall include all activities necessary for construction, installation/erection, testing and completion of all works associated as per scope. The scope of work defined herein shall be read in conjunction with all technical documents (BOQ, specifications, drawings, etc.) included in this tender document.

Construction, Installation and Erection of all supplied materials and site supervision, management, planning and control of the whole project from contract award to final acceptance by the company by ensuring security, safety and compliance with HSE requirement shall be the responsibility of the Contractor.

Contractor shall receive all material from OGDCL yard at designated field and make all necessary arrangement for its safe transportation to project site. Contractor shall borne all levies, taxes as applicable during the transportation of material under scope of the Contractor to the project site.

Contractor shall use the above mentioned technical requirements as minimum. Compliance with the requirements of the tender document does not relieve the Contractor of his responsibility for construction of entire flow line meeting all the statutory requirements, codes & standards, safe industry practices, rated operating and service conditions & as per instruction and approvals from Engineer Incharge

Contractor shall furnish all construction materials, tools and consumable supplies required for the project and shall make the complete installation of works covered in Scope of Work.

The project when turned over to Company shall be in a commissioned condition with successful and tested performance. It shall be Contractor's responsibility to see that all works is completed in accordance with the Specifications, drawings relevant codes and standards.

It is not the intent of this SOW to include every individual scope, specification and component that would be needed for the project. Contractor shall be responsible to include all such scope, specification and component for the project in order to meet the overall requirement of the SOW. Any item not identified due to any error, mistake, omission, deficiency and lack of accuracy but is required in the scope shall be



deemed to be included and contractor shall perform and assume full responsibility at no cost to OGDCL.

To achieve the maximum quality work and full satisfaction, it is mandatory requirement that all works must be carried out under supervision of Contractor's Engineers with Site supervisor & skill labor of adequate experience. The Contractor shall be responsible for liaison and coordination with Company and Suppliers. Liaising with certifying Local Authorities to obtain the permissions and licenses for executing the work and preparation of all the necessary documentation shall be in the Contractor's Scope of Work.

The Contractor shall provide all management, planning, control, QA/QC, services, vehicles, ordinary and special tools, test equipment's, transport, labor, and supervision and all other necessary arrangements regarding the execution of the specified work and arrangements for the security of its personnel.

The Contractor shall furnish construction and consumable supplies required for the project and shall make the complete construction and installation of the Project covered in this Scope of Work.

The Contractor shall provide a temporary camp for his own personnel. The Contractor shall also establish a warehouse where he will store/place all equipment and material. The Contractor shall maintain scores record of all equipment and material and handover such records to Company after completion of the Project to facilitate reconciliation of consumed/installed and left over equipment/material.

The Contractor shall also establish all necessary workshops /fabrication shops for execution of project construction activities. Mobilization & Demobilization of all equipment, camps, stockyard, workshops, fabrication shops, etc. and cleaning / restoring these areas, shall also be the responsibility of the Contractor. The Contractor shall carryout the necessary temporary works, and construct, install and mechanically complete all the works and submit all documentation as required by this Document. This also includes furnishing temporary electrical supplies, lighting, water, etc. required for construction purposes.

The construction, installation and mechanical completion activities shall take full account of other work being carried out. During construction works the Contractor



shall ensure, together with his own personnel and equipment, the safety of the existing equipment and material at site.

The Contractor shall abide by the Company's safety policies/procedures and shall ensure that his work in any way shall not affect normal operation of existing facility / pipeline. The Contractor shall clearly identify the areas of works inside in operation and shall make all arrangements required for safe execution of construction related activities. The Contractor shall also be responsible for obtaining all hot or cold permits or any other permits as deemed necessary by the Company on day-to-day basis.

The Contractor shall make all necessary work plans/procedures as required by the Company's Engineer Incharge and shall submit the same for approval prior to execution. The Contractor shall ensure completion of all works within the agreed time schedule with due diligence and shall make all necessary arrangements.

All work shall be carried out by Contractor under the best and latest approved practices in the oil and gas industry. Health, Safety and Environment requirements and provisions shall be in accordance with the requirements of the Contract and shall fully comply with Company's policies/procedures.

Contractor shall also comply with the QA/QC, Safety, Planning and Scheduling requirements of the Contract throughout the execution of the Project. Unit / Area wise description / scope are given in the succeeding sections.

The contractor shall be responsible for the timely submission to the local or other authorities of such details of his proposals for the works as will be necessary to the comply with all relevant legislation and obtain all permission and approvals stipulated. The applications shall be made by the contractor, as agent of the OGDCL and allowance for all costs related to thereto, including any local or other authority charges, shall be deemed to be included in the contract price.

In addition, approval shall be obtained by the contractor from the local authority regarding safe means of escape and fire prevention measures before relevant construction work proceeds.

Providing detailed manpower and construction plant loading charts. Providing schedule and progress reporting in accordance with the requirements of the



Contract. Providing and implementing a quality assurance plan and developing and implementing quality control procedures.

Maintaining all temporary facilities required for the Works. Contractor is responsible to provide temporary access road to Site for use during construction period. Maintaining construction records such as QA/QC inspection records, test certificates, for final submission to OGDCL.

Protection of all adjacent properties, Pipelines and environment against damage due to construction and erection activities. Protection of materials and (partially) erected facilities/Pipeline against damage or deterioration due to construction activities or by meteorological conditions. Preparing and performing good housekeeping practices and procedures at all areas, including but not limited to the following:

- Prevention of undue waste build-up;
- Keeping areas tidy;
- Keeping roads clean and emergency exit clear;
- Containing dust-producing activities.

Verification of the existing facilities/Pipeline at the proposed and other locations associated with the Project. Contractor is responsible to protect the existing above ground and underground services and if the need arises.



5.0 SCOPE

- 1.1 This specification defines the minimum requirements for the various activities to be carried out by Contractor for the construction of Pipeline.
- 1.2 The various activities covered in this specification, SOW, BOQ, etc during pipeline construction.
- 1.3 Contractor shall submit detailed work procedures including drawings, calculations as required equipments, Machinery, Engineer, Supervisors, Skilled, unskilled manpower deployment details for the all pipeline activities, to Employers Engineer Incharge for approval. Entire work shall be carried out as per approved procedures and to the satisfaction of Employer Engineer Incharge.
- 1.4 Contractor shall mobilize required resources like man power / equipment's necessary consumables tools materials for temporary use and other facilities to complete the construction as per specifications & requirements of Employer / other authorities along the ROW at no extra cost to Employer.

6.0 REFERENCE CODES, STANDARDS AND SPECIFICATIONS

- 2.1 Reference has been made in this specification to the latest codes, standards and specifications
 - i) ASME B31.8 - Gas Transmission and Distribution piping systems
 - ii) ASME B31.4 - Pipeline transportation systems for liquid hydrocarbons and other liquids.
 - iii) API 1104 - Standard for Welding Pipelines and related facilities
 - iv) API 1105 - Bulletin on construction practices for oil and products pipelines
 - v) Part 192 - Transportation of natural and other gas by pipeline
Title 49 (U.S Department of Transportation – Pipeline safety standards)
 - vi) Part 195 - Transportation of liquids by pipeline (U.S department of Transportation – Pipeline safety standards)

7.0 HANDLING, HAULING, STRINGING AND STORING OF MATERIALS

7.1 GENERAL

Contractor shall be fully responsible for all materials and their identification until such time that the pipes and other materials are installed in permanent installation. Contractor shall be fully responsible for arranging and paying for stacking/storage areas for the pipeline materials, however, method of stacking/storage shall be approved by Employer.

7.2 LINE PIPES

The Contractor shall load, unload, transport and stockpile the bare/coated pipes using approved suitable means and in a manner to avoid damage to the pipe and coating. Contractor shall submit to Employer a complete procedure indicating the manner and arrangement used for handling, transportation and stacking of bare/coated pipes for Employer approval prior to commencement of handling operations.

Stacks shall consist of limited number of layers so that the pressure exercised by the pipes' own weight does not cause damage to the coating. Contractor shall submit the staking height calculations as per API RP 5L1 to Employer for approval. Stacks of different diameter, wall thickness and damaged, rejected pipe shall be separately segregated and identified properly. The pipes shall be stacked at a slope so that driving rain does not collect inside the pipe.

The ends of pipes during handling and stacking shall be protected with bevel protectors. Supports shall be provided for at least 10% of the pipeline length. These supports shall be lined with rubber protection. The second layer and subsequent layers shall be separated from each other by material such as straw in plastic covers or mineral wool strips or equivalent.

Materials excluding line pipes shall be stored in sheltered storages.



7.3 STRINGING OF PIPE

Pipes shall be unloaded from the stringing trucks/trailers and lowered to the ground by means of boom tractor or swinging crane or other suitable equipment using lifting devices. Dragging or sliding of pipe shall not be permitted. Special precaution shall be taken during stringing of corrosion coated pipe as per the special requirements of previous para. Stringing of pipe shall only be carried out in daylight and after clearing and grading operations have been completed. Pipe shall not be strung on the Right-of-use in rocky areas where blasting may be required, until all blasting is complete and the area cleared of all debris. Contractor shall submit to Employer for approval a complete procedure for stringing of line pipes.

Pipes shall be supported either by wooden skids or by a suitable material filled in the empty cement bags at a height of at least 500 mm above terrain level.

7.4 REPAIR OF DAMAGED PIPES

After the pipe has been strung on the Right-of-Way it shall be inspected by the Contractor and the Employer and all defective pipes and pipe ends shall be repaired. Defective pipe shall be repaired or rejected as the Employer may direct as per the requirements of specification.

7.5 IDENTIFICATION

For all pipes, numbers and lengths shall be identified and recorded properly. Before a pipe end is cut, the painted pipe number and cold die stamped pipe number shall be transferred by Contractor in presence of Employer to either side of the joint which is to be made by cutting.

8.0 BENDING

Contractor shall preferably provide for changes of vertical and horizontal alignment by making elastic bends. Contractor may provide cold field bends, at its option for change of direction and change of slope. Cold field bends shall be used for bends up to 18°. For bends more than 18° hot induction bends shall be used. Employer at its option may authorize hot bends for installation at points where in Employer's judgment the use of such bends is unavoidable.

Over bends shall be made in such a manner that the centre of the bend clears the high points of the trench bottom. Sag bends shall fit the bottom of the trench and side bends shall conform and leave specified clearance to the outside wall of the trench.

8.1 COLD FIELD BENDS

- 8.1.1 The minimum radius of cold field bends shall be 40 D where D is outside diameter of the pipe.

Contractor shall use a bending machine and mandrel and employ recognized and accepted methods of bending of coated pipe in accordance with good pipeline construction practice. However, bending machines shall be capable of making bends without wrinkles, buckles, stretching and with no damage to the coating.

- 8.1.2 Contractor shall, before the start of the work, submit and demonstrate to Employer a bending procedure, which shall conform to the recommendations of the bending machine manufacturer. The procedure shall include amongst other steps – lengths, maximum degree per pull and method and accuracy of measurement during pulling of the bend. This procedure and the equipment used shall be subject to Employer's approval.
- 8.1.3 For welded pipes, longitudinal seam shall be suitably placed as per approved procedure so that the weld seam shall not be overstressed. Care shall be taken to ensure that after positioning and welding the bend the seam shall be in upper quarter 335° to 45° of the pipeline (pipeline top shall be considered as Zero position).
- 8.1.4 The ends of each bend length shall be straight and not involved anyway in the bending. The length of the straight section shall permit easy joining. In no event shall the end of the bend be closer than 2m from the end of a pipe.
- 8.1.5 The ovality used on each pipe by bending shall be less than 2.5% of the nominal diameter at any point. Ovality is defined as the reduction or increase in the internal diameter of the pipe compared with the nominal internal diameter. A check shall be performed on all bends in the presence of Employer by passing a gauging pig / buckle detector consisting of two discs with a diameter equal to 97.5% of the nominal internal diameter of the pipe connected rigidly together at a distance equal to 300mm.



- 8.1.6 Cold bend pipes on site shall have the corrosion coating carefully checked with the aid of a holiday detector for cracks in the coating down to the pipe wall. It must also be checked whether the coating has disbonded from the pipe wall during bending by beating with a wooden mallet along the outer radius. Any defects or disbonding of the coating caused during bending shall be repaired at the Contractor's expense in accordance with Employer approved procedures.

8.2 MITER AND UNSATISFACTORY BENDS

All bends showing buckling, wrinkles, cracks or other visible defects or which are in any way in disagreement, in whole or in part, with this specification shall be rejected.

No miter bends shall be permitted in the construction of the pipeline. Cutting of factory made bends and cold field bends for any purpose are not permitted.

9.0 LINING UP

Each length of pipe shall be thoroughly examined internally and externally to make sure that it is free from visual defects, damage, severe corrosion (sea water pitting), dirt, animals or any other foreign objects. Each length of the pipe shall be adequately swabbed, either by use of canvas belt disc of proper diameter or by other methods approved by the Employer. Damaged/ corroded pipes shall be kept separate. Each length of pipe shall be pulled through just before being welded. Contractor shall submit a detail procedure for Lineup of line pipe to Employer for approval.

9.1 PIPE DEFECTS AND REPAIRS

- 9.1.1 Acceptability of defects in the pipe detected during inspection at the work site shall be determined in accordance with the project specification for Welded Linepipe or approved procedures or Code ASME B31.8/B31.4 whichever is more stringent.

- 9.1.2 Repair on line pipe shall be executed as specified in project specification for Welded Line pipe and specification for 3Layer Polyethylene Coating or Code ASME B31.4 whichever is more stringent.

Repair of damaged pipe ends by hammering and/or heating is not allowed. Contractor shall submit detailed procedure for pipe defects and repairs to Employer for approval

9.2 SKID SPACING

- 9.2.1 A strip of soft material shall be placed in between skid and pipe to protect the external coating of pipe from any damage.
- 9.2.2 The pipes shall be maintained at the minimum height of 500mm above ground and spacing between skids shall be 6.0 mtrs maximum.

9.3 NIGHT CAPS/TEMPORARY CAPS

After each day's work or when work is interrupted, the open ends of the welded strings of pipes shall be capped with a securely closed metal cap as approved by Employer.

10.0 WELDING OF PIPELINE

Refer the project specification for pipeline welding (2664-SP-001)

11.0 FIELD JOINT COATING

Refer the project specification for Field Joint Coating of pipeline (2664-SP-005)

12.0 LAYING

12.1 LOWERING IN TRENCH

- 12.1.1 Lowering shall follow as early as possible, after the completion of the field joint coating of the pipeline. In the case of parallel pipelines, laying shall be carried out by means of successive operations, if possible without interruption. Contractor shall submit a detail procedure for lowering of pipeline to Employer for approval. Contractor shall submit the pipe book with necessary data / backup, for the section to be lowered at least 2 days before the schedule of lowering to the Employer to have a complete check after signing by Contractor's Quality Team.
- 12.1.2 Before lowering in, a complete check by a full circle holiday detector for pipe coating and for field joint coating shall be carried out and all damages repaired as agreed by Employer at Contractor's cost. All the points on the pipeline where the coating has been in contact with either skids or with lifting equipment shall be properly checked. Where water is present in the trench, no laying shall be permitted until the ditch has been drained.



12.1.3 The pipeline shall be lifted and laid using, for all movements, necessary, suitable equipment of non-abrasive material having adequate width for the fragility of the coating. Care shall be exercised while removing the slings from around the coated pipe after it has been lowered into the trench. Any damage caused to the coating shall be promptly repaired. Lowering in utilizing standard pipe cradles shall be permitted if Contractor demonstrates that pipe coating is not damaged. No sling shall be put around field joint coating.

Roller cradles with proper outer lining can be used after approval of Employer in place of sling belts.

12.1.4 The portion of the pipeline between trench and bank shall be supported by as many side booms as required and approved by Employer for holding the line in gentle S-curve maintaining minimum elastic bend radius as specified in approved procedure. Lowering in and back filling shall preferably be carried out at the highest ambient temperature.

12.1.5 Over-head sections

- a) The following works shall be completed before proceeding with the assembly and laying of overhead pipelines:
- Construction of the pipe support structures or of mounts on supports.
 - Paints and/or coating of the pipe work, as indicated in the engineering specification.
- b) The erection of the supports shall be carried out taking care that the elevation and alignment is in accordance with the drawings.

In the case of metal work supports, pre-fabrication and/or assembly shall take into account the maximum allowed free span and the supports shall not interfere with the pipeline welds.

- c) In case roller supports are used, the rollers shall be lubricated, and then checked for smooth rotation and, in case of seizure, the defect shall be repaired or roller shall be replaced. In the case of overhead section where the pipeline is slanting, the alignment of the end supports shall be made after placing the pipeline in position. Before installation of the pipe section, all the rollers shall be perfectly centered acting on the seat of the support plates.

The above alignment operations shall be carried out before connecting the overhead section with the ends of the buried section.

- d) Lifting, moving and laying of the pipeline shall be carried out in accordance with the provisions of this specification.

An insulation sheet shall be installed to isolate the pipe from the support or support from the earth.

The sheet shall be hard polyethylene at least 8mm thick.

It shall extend at least to 25 mm outside the saddles or clamps.

- e) Moving supports, if any shall be centered on their support and allow for a movement of at least 300mm in both directions.
- f) A comprehensive report / method statement on the laying operation to be used shall be submitted to the Employer well in advance for approval. The report as a minimum shall include, but not limited to the following:
- Method of installation by lifting (as a preferred method).
 - Pulling method and related calculations, whenever lifting method cannot be used.
 - Pulling device and its characteristics.
 - Method of anchoring the pulling device
 - Characteristics of the pulling rope
 - Braking device, if any.
 - Pipeline assembly system.

13.0 PIPELINE TIE-IN

13.1 The unconnected sections of the pipeline at various locations have to be tied in after the sections are coated, lowered and backfilled. The sections to be connected shall have at the ends, sections of over lapping, uncovered pipe of sufficient length to absorb, without including excessive stresses in the steel, small displacements necessary for perfect alignment and connection of the ends.

13.2 If a pup end cannot be avoided for tie-in, the minimum length that shall be added is 2.5meters and two or more such pups shall not be welded together. All cut-off lengths greater than 2.5 meters shall be moved ahead in order to be welded into the pipeline at a suitable location. Tie-in with two or more pups may be used provided that they each have minimum length of 2.5meter and are separated by an entire length of pipe. In no case more than three

13.3 welds shall be permitted on a 10 meter length of pipeline.

14.0 CROSSINGS

Pipe line sections at all major crossings like State and National Highways, Railways, major canals and lined canal / distributaries shall be laid by boring with casing pipe complying with all other statutory requirements. All other crossings shall be executed by open cut method unless otherwise specified in the Contract or specified by statutory authorities.

Refer the project specifications for Pipeline Crossing Roads, Rail Roads and Minor Water Ways.

15.0 INSTALLATION OF INSULATING JOINTS

15.1 Insulating joints shall be installed at the locations shown in the drawings. Contractor shall obtain approval from the Employer before installation of the insulating joints.

15.2 Handling and installation of the insulating joints shall be carried out with all precautions required to avoid damage and excessive stresses and that the original pup length is not reduced.

15.3 The insulating joints and the welded joints shall be protected by external coating as per the relevant specifications issued for the purpose.

15.4 Before welding insulating joints in to pipeline, it shall be megger testes to check the integrity of insulation.

16.0 WORKING SPREAD LIMITATIONS

Contractor shall, in general, observe the following maximum distances between the working mainline spread.

Between Row grading, clearing and backfilling : 25Kms.

Between Backfilling and final clean up : 5Kms.

17.0 CLEAN-UP & RESTORATION OF RIGHT-OF-WAY

17.1 After all required tests have been concluded satisfactorily Contractor shall clean up the site as laid down in the specifications issued for the purpose. The site finish shall be graded in accordance with the approved drawings.



- 17.2** Contractor shall restore the ROW and all sites used for the construction of pipelines, water crossings and other structures in accordance with Employer instructions and deliver them to the satisfaction of Employer.

18.0 INSPECTION OF SITE

CONTRACTOR shall be deemed to have inspected and examined the SITE and to have full and complete knowledge of the conditions of the site and its surroundings on its own responsibility and satisfied itself before submission of BID PROPOSAL and to have taken into account any information in connection therewith, which may have been provided by or on behalf of COMPANY.

The CONTRACTOR and any of its personnel or agents will be granted permission by the COMPANY for site visit, upon the express condition that the CONTRACTOR, its personnel or agents will relieve and indemnify the Company from and against all liability in respect thereof including personal injury (whether fatal or otherwise), and any other loss, damage, costs and expenses, including kidnapping, murder of CONTRACTOR's personnel, or any disease etc.

Due to visa requirement in Pakistan, CONTRACTOR should initiate / complete all requirements/ formalities for obtaining Visa of their nominated personnel (if applicable) for site visit at the earliest.

COMPANY shall not accept any claim from CONTRACTOR by reason of any error, insufficiency or omission due to COMPANY'S information.

COMPANY must receive requests for site visit at least ten (10) calendar days before the BID CLOSING DATE. All personnel (including local as well foreign expats) security clearance / NOC (applicable for foreign expats) and arrangements shall be solely on Bidder's account.

19.0 MOBILIZATION / DEMOBILIZATION

Upon receiving the Provisional Acceptance of the Works by OGDCL, CONTRACTOR shall bring entire inventory dedicate or required for Project completion from Sinjhora Gas Field, OGDCL to the CONSTRUCTION site area. Upon completion of project CONTRACTOR shall remove all equipment and material within the CONSTRUCTION facilities to CONTRACTOR's own temporary facilities then back to

or directly bring it back to the designated place in Sinjhor Gas Field, OGDCL. This work shall include but not limited to:

- CONTRACTOR shall be responsible to develop all temporary facilities including site office, workshop, crane, heavy machineries, storage place, camp accommodation, utilities etc.
- CONTRACTOR shall be responsible to pave a road in order to transport equipments, parts and everything which they intend to use for Project purpose.
- Upon completion of work, CONTRACTOR shall be responsible for dismantling and removal of all temporary facilities (Site Office, Workshop, Stores, Camp accommodation etc.) and utility systems;
- Removal of all balance construction equipment, machinery, tools, cranes, scaffolding etc. from site;
- Removal of all surplus equipment and materials and hand over to OGDCL wherever applicable;
- Reinstatement of the areas of temporary facilities to a clean and tidy condition to the satisfaction of OGDCL;
- Re-export of construction equipment, machinery, cranes etc., if temporarily imported for sole purpose of construction of the Project under this Contract, in conformance and compliance to the applicable government laws, regulations and procedures;
- CONTRACTOR to keep the required facilities at Worksite during Warranty Maintenance period;
- To return to OGDCL surplus/ left over materials supplied by OGDCL (if any).

CONTRACTOR is required to keep and maintain required personnel, equipment and facilities namely site office and its facilities and accommodations etc. for OGDCL representatives and CONTRACTOR to perform the punch list clearing and Warranty work at SITE during Warranty Period.

20.0 QUALITY ASSURANCE AND QUALITY CONTROL

General

Contractor shall be responsible to plan, establish, implement and maintain a Quality system for the fabrication, installation; pre-commissioning, commission and



performance testing of the Wellhead Flow line as per ISO 9001 and requirements of project specification for Quality Assurances.

Contractor shall submit a copy of CONTRACTOR'S policy statement on their corporate quality manual and procedures, as a part of their bid, for review by OGDCL.

Contractor shall be responsible for all Quality Assurance and Quality Control functions and shall at all time s provides adequate, competent and qualified supervision and inspection personal, approved by OGDCL, to ensure that the quality of work is met and timely inspected.

Contractor shall supply all the relevant quality assurances requirements to its Subcontractors, suppliers etc. involved in the Project for compliance and shall be responsible of Overall Project Assurance and Quality Control.

Quality Control

Quality control activities for the Project shall include the following, as minimum:

- Development of inspection and test plans (ITPs) , procedures, schedules and reports for Procurement/Construction;
- Review, approval and monitoring of Vendor / Subcontractors inspection and & test plans;
- QA/QC requirements for Subcontracts / Vendors:
- QA/QC requirements for all site related activities (Field QA/QC plan);
- Design control:
- Quality control of procurement procedures;
- Document Control:
- Safety & Environment Control;
- Verification of all test certificates for compliance with OGDCL requirements.

To achieve the above objective, dedicated QC personnel are required for the work.

Quality Assurance Manual

The contents of Contractor's Quality Assurances Manual Shall Cover

- Civil / Structure Construction;
- Pipeline laying

- Piping fabrication / Manifolds;
- Valves, Check vales, Safety Valves; (if any)
- Pipes and fittings;
- Handling and lifting

21.0 INSPECTION, TESTING AND PRE-COMMISSIONING

Checking and Inspection

Mechanical Completion Inspection

The Contractor shall use the relevant drawings and documents to check that all pipe work, supports and connections are mechanically complete. Mechanical completion inspection shall include the checking of all connections to ensure that they have been made off in the correct manner and have been tightened in readiness for pressure testing.

Checking & Inspection after Installation

Checking and inspection after installation shall include the following:

- Visual inspection of installations shall be carried out to make sure that all connections and fixing are tight, all wiring, tubing, fittings are correct to the drawings and labels are correctly engraved.
- All defects or faults shall be corrected by the Contractor.
- Any faults in work performed by the Contractor shall be corrected by the Contractor at their own expenses.

Any faults in material or equipment or line segment furnished by others which are the result of careless, incompetent or improper handling or installation by the Contractor shall be corrected or replaced promptly by the Contractor at their own expenses.

Test Records

The Contractor shall keep records of the tests and upon completion, a test certificate for every installation, recording all results, shall be handed to the OGDCL / Engineering Consultant.

Provide Commissioning Support

Contractor shall provide all kinds of commissioning supports for instrumentation installation works (if applicable).



Third Party Inspection

The required inspection shall be performed by qualified Third Party Inspection Agency engaged & employed by duly approved by OGDCL.

22.0 MECHANICAL COMPLETION

Contractor shall provide experienced and qualified personnel to perform pre-commissioning activities and achieve Mechanical Completion.

Contractor shall note that Commissioning of the entire systems and or facility identified in the Contract shall not commence until Mechanical Completion of the systems has been achieved and a Mechanical Completion Certificate has been issued by OGDCL.

Contractor shall provide all necessary pre-commissioning equipment, tools, instruments and fluids such as fresh, clean, inhibited water, chemicals, temporary power, compressed air, nitrogen, lube oils, fuel, etc. Contractor shall also provide all necessary pre-commissioning spare parts.

Contractor shall execute all scheduling, planning and progress reporting including planning meetings. Contractor shall comply with the pre-commissioning requirements as defined hereinafter, in accordance with the specifications. Contractor shall provide all test equipment & site radios required for loop testing. Mechanical Completion shall be a systematic and progressive activity leading to issuance of a Mechanical Completion Certificate from OGDCL.

23.0 MECHANICAL COMPLETION CERTIFICATE

The Mechanical Completion date is considered as the date of the last pre-Commissioning satisfactory test and approval of the Mechanical Completion Certificate by OGDCL for the last portion or system of the Works.

Upon completion of all the pre-commissioning requirements related to each individual system (portion of the Works) and such system is ready for commissioning and to receive hydrocarbon, CONTRACTOR shall apply for a Mechanical Completion Certificate for this system and submit to OGDCL with the pre-commissioning results.

Subsequently, OGDCL representative shall carryout inspection of the subject system.

24.0 PRE – COMMISSIONING ACTIVITIES

Pipe Hydra Test

Contractor shall prepare and submit the Hydro test and flushing procedure, for OGDCL review and approval. The procedures shall highlight the system portion/ parts that must be isolated during the tests. The procedure shall highlight the valve and instruments or any unit that must be isolated during the test;

Contractor shall adhere to the Hydro test and Flushing Procedure prior to closing up the piping systems. Contractor shall ensure that no foreign materials are left in the pipes and which could not be flushed out during flushing;

Contractor is responsible to supply water for hydro test and leak test purpose. Hydro test water shall be analyzed for chemical composition for suitability of usage;

It is Contractor's duty to carry out any weld repairs; every repair shall undergo another hydraulic test under the same previous conditions;

Contractor shall utilize calibrated instruments. The satisfactory measurement readings shall be followed by the signature of OGDCL's Representative;

Contractor shall submit a programme for any testing works for OGDCL's approval not later than two (2) weeks prior to commencement of testing;

All pipe works are to be pressure tested in accordance with the procedures and specifications and the following requirements shall be fully complied with:

Contractor shall be responsible for properly preparing Works for pressure testing;

During the whole period of testing the Works, Contractor shall provide and install in accordance with the specifications and drawings, calibrated and accurate tests gauges and recorders and all other necessary materials and equipment required to perform pressure testing;

All welded joints may be painted with primer only in order to prevent initial corrosion until the completion of non-destructive and pressure testing before full coating is allowed;

After completion of hydrostatic test, a reinstatement test for each system shall be conducted at a test pressure 95% of the lowest rated relief valve setting in the system. When no relief valves are present, the system shall be reinstated at 110% of the system operating pressure.



Contractor shall prepare and submit the reinstatement procedure to OGDCL for review and approval 2 weeks in advance of any reinstatement works; Instrument air leak test shall be carried out by Contractor to all hydraulic signal lines. Leak test shall be done by using a bubble tester. The maximum allowable leakage rate shall not exceed 7 bubbles per minute. This test shall be witnessed and verified by Contractor quality control inspector and OGDCL Representative;

Upon completion of hydrostatic pressure testing, Contractor shall drain and dry to the satisfaction of OGDCL, the piping by suitable method approved by OGDCL;

Contractor shall remove all temporary facilities installed by Contractor once testing is completed to the satisfaction of OGDCL. Tests shall be witnessed by OGDCL and records of all tests shall be furnished to OGDCL within forty eight (48) hours of the test. Completion of final flushing of piping shall be after the reinstatement testing and acceptance by OGDCL. All pipe works shall be adequately flushed using a high pressure and high volume flow of fresh and clean water upon completion of installation. Flushing shall be carried out with all valves fully open. Contractor shall ensure that adequate fresh and clean water be made available to perform the above works. It is Contractor's responsibility to dispose of all cleaning water.

30.0 COMMISSIONING

Contractor shall be responsible to supply the feedstock at the new system boundary limits as required to perform the commissioning and Performance Tests.

Contractor shall execute all activities required for commissioning and start-up of the new facilities including necessary utilities supply.

At least three (3) weeks prior to the Commissioning and Performance Test, a Safety and Commissioning Start up Audit shall be conducted and attended by the Contractor, OGDCL Project Team and Production Team. Contractor is responsible to complete the activities identified as critical during the audit before proceeding with Commissioning and Performance Test.

Contractor shall note that Commissioning shall generally include the following activities and such activities are to be completed prior to Performance Test of the FACILITY: Operational testing of the equipment (at maximum operating pressure) and inerting as required. Operational and functional testing of instrumentation,



control, and safety systems, CONTRACTOR shall prepare a Pre-commissioning and Commissioning Procedure document.

COMMISSIONING RESPONSIBILITY

Provision of a team of suitably experienced and qualified personnel including management, supervision, labor, and the necessary assistance by SUBCONTRACTOR's /VENDOR's commissioning specialists, for commissioning as per approved plans, schedules and procedures, including the appointment of a Commissioning Manager; Preparation of interface and commissioning co-ordination procedures together with supporting documentation including "Highlighted and Red Line Mark-up" drawings. CONTRACTOR shall prepare and submit Commissioning Manual to OGDCL for approval, six (6) weeks in advance;

Preparation of safety audits and recording of all approved safety audit items to ensure the required safety;

Provision of all commissioning spare parts and consumables and ensuring their availability at Worksite at least four (4) weeks prior to commissioning of facility;

Provision of consumables including nitrogen, helium, water; Diesel, lube oil, grease, other consumables, etc for COMMISSIONING activity;

Provision of consumables including nitrogen, helium, water; Diesel, lube oil, grease, other consumables (if applicable), etc for first fill-up during start-up after COMMISSIONING.

Development of all required software items including programming /interfacing with existing operational controls;

Maintenance of all documentation and records of Commissioning Activities on microcomputer including execution and documentation of performance tests of commissioning systems;

Maintenance of records of all design changes for updating the operating manuals;

Provision of mechanical, electrical and instrumentation test and measuring equipment and special tools and accessories necessary to carry out calibration, testing, trouble shooting and repair to ensure timely completion of commissioning activities;



Preparation and issue of the Commissioning dossier of the individual systems;

Identification of commissioning activities including definition of piping, electrical and instrumentation test systems, definition of commissioning systems and definition of performance test program;

Provision of sufficient portable walkie-talkies sets for use during commissioning;

Ensuring adequate and timely operator involvement in the preparation of the commissioning activities, and close liaison and co-ordination with OGDCL's Operations, Maintenance and Safety;

Provision of a detailed commissioning plan, procedures, schedules and reports which shall be submitted to OGDCL for approval. Ensuring documented recording and reporting;

Submission of operating and maintenance manuals and Performance Test Procedures for OGDCL approval, six (6) weeks prior to Performance Test; Provision of spades /gaskets /bolts for tie-in works, as necessary; Obtaining and complying with the necessary permits and approvals.

26.0 CONSTRUCTION COMPLETION

Contractor shall prepare a construction completion procedure as part of the construction plan as developed under the execution plan.

The construction completion procedure shall include checklist forms, document flow, schedule, certification scheme and status monitoring method for attaining Construction Completion. Separate checklists for different systems and for different disciplines of engineering will be required.

All documents, checklist forms and procedures required for Construction Completion shall be compiled in a construction punch list, which itself forms a part of the documentation which has to be submitted and approved prior to the achievement of Construction Completion. All quality control data to support this documentation shall be filed in a separate quality control dossier for each Subsystem.



OIL & GAS DEVELOPMENT COMPANY LIMITED
Laying of pipelines from Pandhi # 1 to Baloch # 1 and Upto to Sinjhoru Plant
(37 KM Approx)
BOQ

PIPELINE WORKS

SR#	ITEM DESCRIPTION	UNIT	QTY.	UNIT RATE	TOTAL COST
				Inclusive of all applicable Taxes without PST/ICT	Inclusive of all applicable Taxes without PST/ICT
				(PKR)	(PKR)
1.1	PIPELINE WORKS				
a	Fabrication, Internal cleaning & welding of pipeline Dia. 8" Sch. 80, Works from Baloch # 1 to Sinjhoru Plant	RM	23000		-
b	Fabrication, Internal cleaning & welding of pipeline Dia. 4" Sch. 40, Works from Pandhi # 1 to Baloch # 1	R.M	14000		-
1.2	Well Head & Valve Assemblies				
	Fabrication, Welding & Intalltion of WHA and Valve assebbly at Pandhi will be constructed 6" dia Sch 120 6" Sch 80,4" dia Sch120 4" dia Sch 80 & 4" dia Sch40.	dia inch	400		-
1.3	HEAT SHRINKABLE SLEEVES				
a	Provision of Heat shrinkable sleeve (preferably Raychem HTLP 80) with patches & primer (compound A+B). Contractor is bound to provide legally procured and taxes paid invoices.	Nos.	3300		-
b	Installation of sleeves which includes shifting of sleeves from store to site, surface preperation, supply & application of primer (Compound A+B) with application KIT complete in all respect.	Nos	3300		-
1.4	HYDROSTATIC TESTING & COMMISSIONING				
	Hydrostatic testing of pipeline as per project specification and Client requirements. Contractor shall provide all material, tools, equipment, supply of water, tempory test plugs, couplings, flanges, nuts, bolts, recorder guage, cleaning ,flushing and all necessary arrangements required for hydrostatic testing would be responsibility of contractor and should be done as per relevant specifications, Codes & standards.	M	37000		-
1.5	PIGGING OF PIPELINE				
	Line shall be cleaned, flushed and made dry by using pigs as per specification, standard practice and to the satisfaction of the Engineer Incharge. Scope also include supply of brand new pigs, pigging of pipeline and all arrangements required for completion of work.	R.M	37000		-



OIL & GAS DEVELOPMENT COMPANY LIMITED
Laying of pipelines from Pandhi # 1 to Baloch # 1 and Upto to Sinjhora Plant
(37 KM Approx)
BOQ
PIPELINE WORKS

SR#	ITEM DESCRIPTION	UNIT	QTY.	UNIT RATE	TOTAL COST
				Inclusive of all applicable Taxes without PST/ICT	Inclusive of all applicable Taxes without PST/ICT
				(PKR)	(PKR)
1.6	CROSSING OF PIPELINE				
	Crossings along the route, including supply of all material, tools, construction of supports, any civil works, re-instatement, seals, insulators, vent, drains and insulation lining for pipeline as per relevant standard's & Code, drawing's and specifications. Crossings includes Roads, Water Courses, Nallah's, canals, Existing pipeline and other required crossings etc. (Note: Anytype of NOC is provided by OGDCL)	-----	-----	-----	-----
a	Thrust Boring	R.M	300		-
b	Horizontal Directional Drilling	R.M	500		-
Grand Total of items @ Sr # 1.1 to 1.6 Inclusive of All Applicable Taxes Exclusive of PST/ICT					
Rate and Amount of PST/ICT on above mentioned Services @%					
Grand Total Inclusive of All Applicable Taxes with PST/ICT					
The above quoted rates are inclusive of all the followings.					
i	Receiving from OGDCL warehouse, Loading, transportation, unloading of pipes, bends and all Allied material at site.				
ii	Stringing of Pipeline along with ROW on sand bags				
iii	Lowering in trench with proper arrangement as per standard.				
iv	Installation of Anchor Flanges & Insulation joints				
v	Installation of factory bends as per requirement.				
vi	Fabrication, Installation and testing of Field-cold bends as per site requirement.				
vii	Supply and placing of sand bags				
viii	Holiday testing and repair of damage coating				
ix	Identifying of already layed different pipelines, cables etc with proper instrument for safe operation				
x	Excavation of Test Pits where required for identification of any underground pipe / structure (Max distance should be 25m b/w each pipe).				
xi	All Cunsumables i-e welding rods "lincon", grinding discs, power brushes ets or any other required for completion				
xii	Area must be cleared and re-instated after completion of work				
xiii.	The bidder must submit complete tender document as available on website and having duly stamped and signed at the time of submission of bid otherwise OGDCL reserves the right ot reject the bid.				
xiv.	The bidder shall clearly mention if he is opting for reduced rate of PST/ICT and his bid shall be evaluated accordingly by adding reduced Sales Tax in their bid price, whereas, the bidder(s) who opt for full rate of PST/ICT, their bids shall be evaluated excluding PST/ICT. No change will be acceptable in the option of rate of PST/ICT after submission of the bid.				
xv.	The Contractor being registered with the respective revenue authority is entitled to charge applicable Sales Tax over and above its bid price (excluding Sales Tax) and will be responsible for the payment of such Sales Tax to the respective revenue authority as per prevailing laws. OGDCL shall reimburse the amount of Sales Tax to the concerned Contractor based on valid payment documents of respective revenue authority.				
xvi.	OGDCL shall withhold applicable Income Tax /PST/ICT as per prevailing withholding rules.				
xvii.	PST stands for Provincial Sales Tax, ICT stands for Islamabad Capital Territory Sales Tax & PKR stands for Pak Rupees.				
NOTES:					
i	OGDCL reserves the right to increase / decrease the quantum of work, after prior approval of Engineer Incharge. However payment will be made on actual work done.				
ii	Contractor to comply with Relevant codes & standards, specifications respectively.				
iii	All area must be cleared and reinstated after completion of work				
iv	In case of water logged area, Dewatering should be done by means of Pumps and its rate should be added as per requirement by the contractor.				
v	For Water logged area Buyoncy weights should be placed on Flowline as per requirement and its rate should be added by the contractor.				
vi	All crossings will be finalized as per site.				
vii	Mobilization / De-Mobilization, Equipment, Machinery, Tools, Manpower, Camping, utilities, etc required for completion of work.				
viii	Establishment of camp at nearist suitable location for execution of work at site shall be responsibility of contractor. Hoever Suitable Land/Area shall be provided by OGDCL.				
ix	Approval of Engineer Incharge should be taken by the contractor before undertaking any kind of construction and installation work at site.				
x	All SOPs of HSEQ should be fallowed throughout the work				

Contractor's Signature & Official Seal



OIL & GAS DEVELOPMENT COMPANY LTD

DRAWINGS

FOR

**LAYING OF PIPELINES FROM
PANDHI#1 TO BALOCH#1 TO SINJHORO PLANT
(APPROX 37 KM's)**

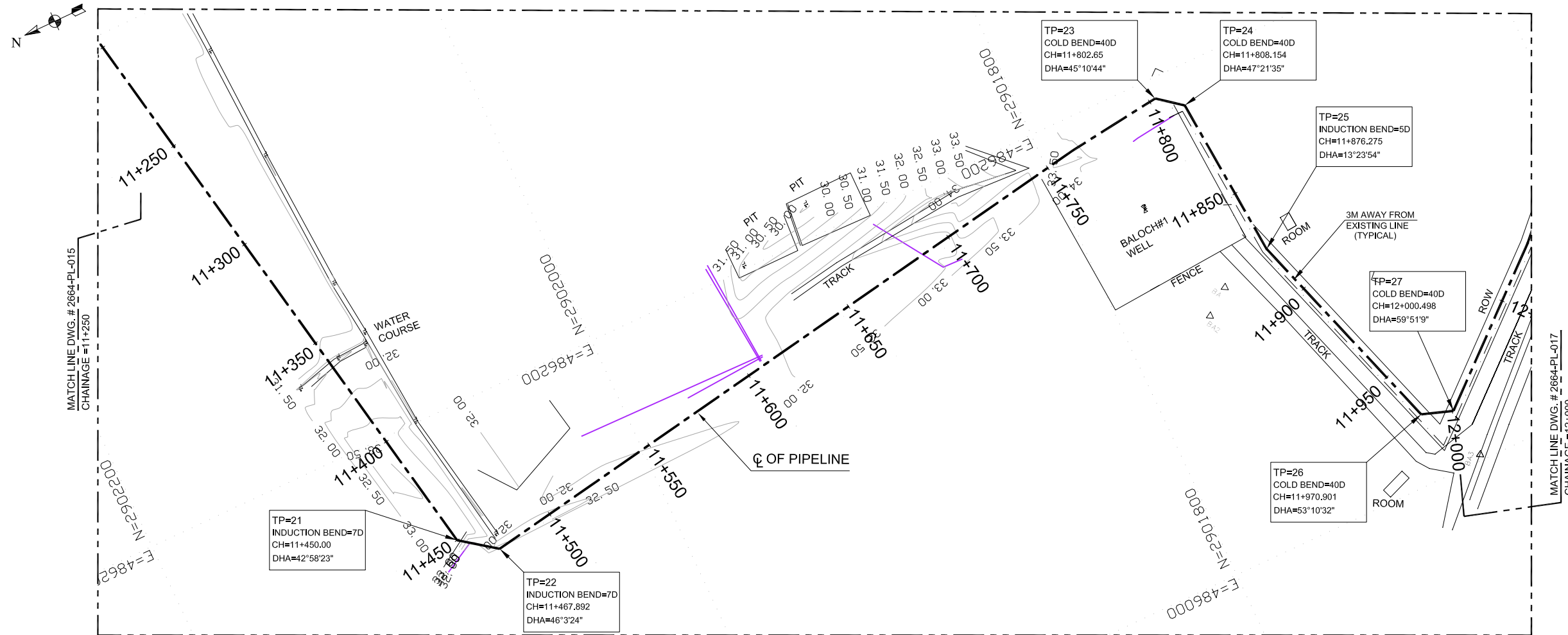

RE-ISSUED FOR CONSTRUCTION

STATION	11+250	11+275	11+300	11+325	11+350	11+375	11+400	11+425	11+450	11+467.89	11+475	11+500	11+525	11+550	11+575	11+600	11+625	11+650	11+675	11+700	11+725	11+750	11+775	11+800	11+806.781	11+821.383	11+825	11+850	11+875	11+900	11+925	11+950	11+975	11+978.653	11+986.538	12+000			
NATURAL GROUND ELEVATION	31.222	31.246	31.321	31.398	31.487	32.476	33.393	33.484	33.345	33.081	31.983	32.569	32.268	31.967	31.87	31.868	32.086	32.244	32.406	32.307	33.12	33.633	34.188	34.306	34.300	34.292	34.351	34.56	34.616	34.653	34.689	34.725	34.762	34.762	34.778	34.759			
PIPELINE ELEVATION(T.O.P)	30.002		30.101		30.267		32.173		32.125			31.349		30.747		30.648		31.024		31.087		32.413		33.086		33.36		33.433		33.505		33.539							
CHAINAGE	11+250	11+275	11+300	11+325	11+350	11+375	11+400	11+425	11+450	11+467.89	11+475	11+500	11+525	11+550	11+575	11+600	11+625	11+650	11+675	11+700	11+725	11+750	11+775	11+800	11+806.781	11+821.383	11+825	11+850	11+875	11+900	11+925	11+950	11+975	11+978.653	11+986.538	12+000			
CROSSING ITEM OF DETAIL					WATER COURSE																																		PIPELINE CROSSING
VEGETATION	COTTON CROP	MUNG BEAN CROP		BARREN LAND		MUNG BEAN CROP										BARREN LAND																							

CONTROL:

SECONDARY SURVEY STATION (GPS)

TP TURNING POINT

LINE PIPE	8 INCH DIA, Sch. 80, CS, API 5L GR.X52.
LINE PIPE INSULATION	THREE LAYER POLYETHYLENE COATED
SPECIFICATION / CLASS	-
FLANGE RATING	CLASS 900# , RF
SERVICE LIMIT	-25 TO 150°F
HYDRO TEST PRESSURE	2250 PSIG.
SOIL COVER MIN.	4 ft

LEGEND :

RIVER / CANAL / DITCH		GROUND PROFILE	
SURFACED ROAD		TREE (NON FRUIT)	
UNSURFACED ROAD		MAJOR CONTOUR	
TRACK / PLATFORM		MINOR CONTOUR	
BANCH MARK		TOP OF HILL	
WALL		TOE OF HILL	
FENCE		VALVE	
PIPELINE PROFILE		WATER LINE	
ELECTRIC LINE		FILLING AREA	
CUTTING AREA			

ABBREVIATIONS:

AT RADIO ANTENNA	PL PIPELINE MARKER
CTM BOUNDARY MARKER	PY ELECTRICITY PYLON
BP CATHODIC MARKER	RL RUNWAY LIGHTS
EP ELECTRICITY POLE	RM RAILWAY MARKERS
FL FLARE	SG SIGNAL
KM KILOMETER MARKER	SH SEISMIC SHOT HOLE
LP LAMP POST	SN SIGN POST
LPM LAND PARCEL MARKER	ST SETTING OUT MARKER
MS MAST	TP TELEPHONE POLE
NV NAVIGATION BEACON	WT WATER STAND PIPE

NOTES :

- ALL DIMENSIONS ARE IN METER UNLESS OTHERWISE STATED.
- HORIZONTAL AND VERTICAL CURVATURE OF SUCH ELASTIC BENDS SHOULD IDEALLY NOT BE LESS THAN A RADIUS OF 500M. WHERE THIS CANNOT BE OBTAINED, THE CURVATURE OF THE CONSTRUCTED FLOWLINE SHALL NOT BE LESS THAN 200M, UNLESS COST-SET ARE USE.
- COLD-SET BENDS SHALL BE OF UNIFORM RADIUS, AND MINIMUM RADIUS OF CURVATURE SHALL BE 40X LINE PIPE DIAMETER.
- ALL COLD-SET BENDS SHALL BE TESTED BY THE CONTRACTOR AND WITNESS BY THE COMPANY, WITH A CALLIPER OF 97.5% OF THE NOMINAL INTERNAL DIAMETER PRIOR TO INSTALLATION.
- IF A LONGITUDINAL WELD IS PRESENT IN THE FLOWLINE PIPE, THE LONGITUDINAL WELD SHALL BE IN THE NEUTRAL ZONE, LOCATED AT AN ANGLE OF APPROXIMATELY 10 DEG TO THE CENTERLINE OF THE PIPE, PERPENDICULAR TO THE PLANE OF BENDING, AND AWAY FROM THE CENTER POINT OF THE RADIUS.
- COLD-SET BENDS SHALL NOT BE MADE CLOSER THAN 2000mm FROM A CIRCUMFERENTIAL WELD. THE END OF EACH BEND SHALL BE STRAIGHT FOR AT LEAST 2000mm. THE CONTRACTOR SHALL LAYOUT AND MEASURE THE FLOWLINE PIPE FOR BENDING, TO KEEP THE LENGTH OF CUT-OFF TO A MINIMUM.
- ALL DIMENSIONS, ELEVATIONS AND ORIENTATIONS TO BE VERIFIED BY THE CONTRACTOR BEFORE UNDERTAKING ANY KIND OF FABRICATION, CONSTRUCTION AND INSTALLATION WORK AT SITE.
- FOR COLD BENDS DETAIL SEE DRAWING # 2664-DT-001.
- FOR RISERS DETAIL SEE DRAWING # 2664-DT-002 & 2664-DT-003.

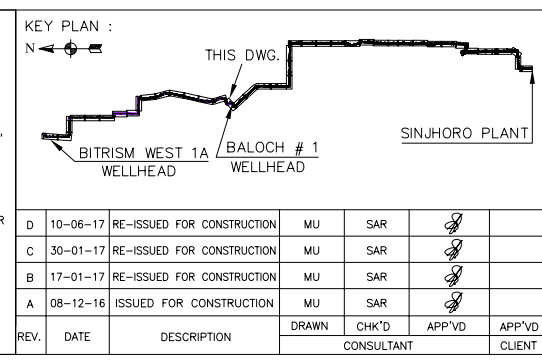

PC PETROCHEMICAL ENGINEERING CONSULTANTS
 C-2, BLOCK NO. 17, GULSHAN-E-IGDAL, NEAR NATIONAL STADIUM, KARACHI-75300, PAKISTAN.
 TEL: +92 (21) 34827780, 34961088, FAX: +92 21 34961089, E-Mail: contact@pec.com.pk web site: www.pec.com.pk

CLIENT: **OIL & GAS DEVELOPMENT COMPANY LTD.**

PROJECT: **DEVELOPMENT OF BITRISM WEST 1A**

TITLE: **PIPELINE ALIGNMENT DRAWING (11+250 TO 12+000)**

D	10-06-17	RE-ISSUED FOR CONSTRUCTION	MU	SAR	
C	30-01-17	RE-ISSUED FOR CONSTRUCTION	MU	SAR	
B	17-01-17	RE-ISSUED FOR CONSTRUCTION	MU	SAR	
A	08-12-16	ISSUED FOR CONSTRUCTION	MU	SAR	

REV.	DATE	DESCRIPTION	DRAWN	CHK'D	APP'VD	APP'VD
			CONSULTANT			CLIENT

DRAWING NO. **2664-PL-016** SCALE **H. SCALE:1/2000** SHEET **1 OF 1**
 V. SCALE:1/1000 A3

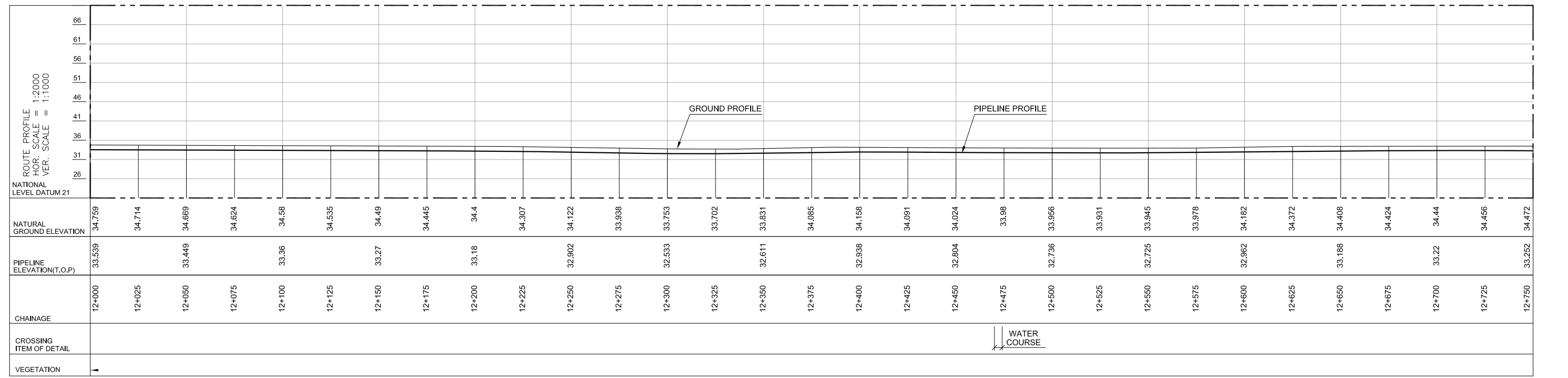
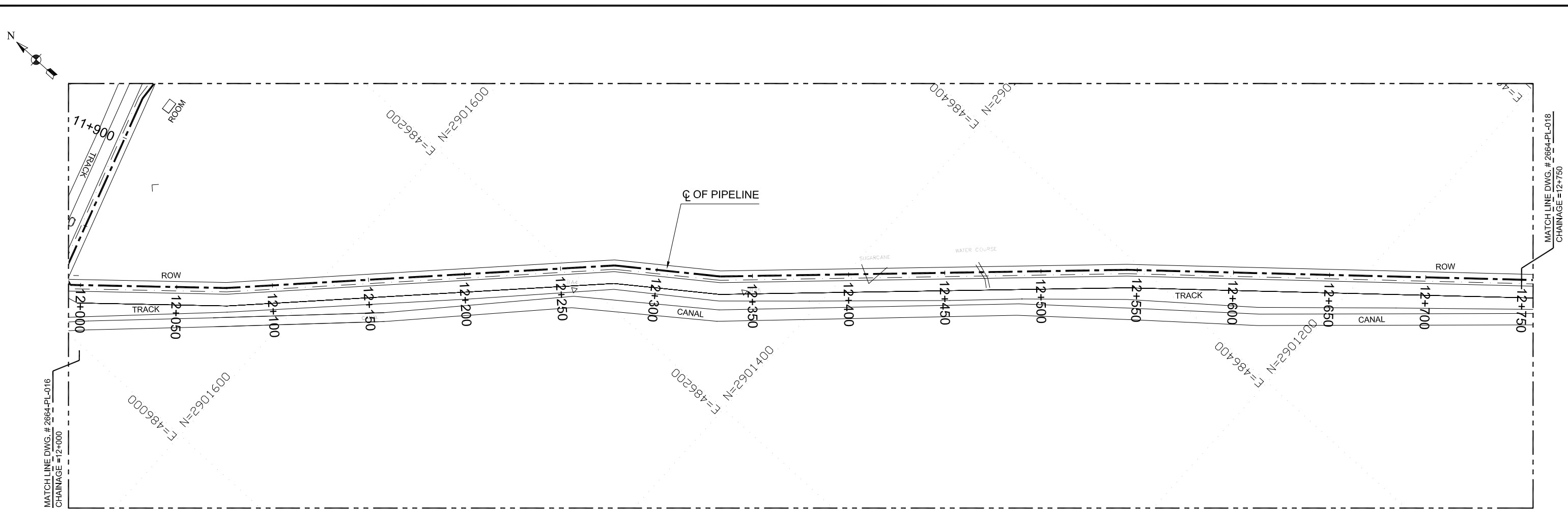

CONTROL:

SECONDARY SURVEY STATION (GPS)

TP TURNING POINT

LINE PIPE	8 INCH DIA, Sch. 80, CS, API 5L GR.X52.
LINE PIPE INSULATION	THREE LAYER POLYETHYLENE COATED
SPECIFICATION / CLASS	-
FLANGE RATING	CLASS 900# , RF
SERVICE LIMIT	-25 TO 150°F
HYDRO TEST PRESSURE	2250 PSIG.
SOIL COVER MIN.	4 ft

LEGEND :

RIVER / CANAL / DITCH	---
SURFACED ROAD	---
UNSURFACED ROAD	---
TRACK / PLATFORM	---
BANCH MARK	●
WALL	---
FENCE	---
PIPELINE PROFILE	---
ELECTRIC LINE	---
CUTTING AREA	▨

GROUND PROFILE	---
TREE (NON FRUIT)	⊙
MAJOR CONTOUR	---
MINOR CONTOUR	---
TOP OF HILL	▲
TOE OF HILL	▼
VALVE	⊕
WATER LINE	---
FILLING AREA	▨

ABBREVIATIONS:

AT	RADIO ANTENNA	PL	PIPELINE MARKER
CTM	BOUNDARY MARKER	PY	ELECTRICITY PYLON
BP	CATHODIC MARKER	RL	RUNWAY LIGHTS
EP	ELECTRICITY POLE	RM	RAILWAY MARKERS
FL	FLARE	SG	SIGNAL
KM	KILOMETER MARKER	SH	SEISMIC SHOT HOLE
LP	LAMP POST	SN	SIGN POST
LPM	LAND PARCEL MARKER	ST	SETTING OUT MARKER
MS	MAST	TP	TELEPHONE POLE
NV	NAVIGATION BEACON	WT	WATER STAND PIPE

NOTES :

- ALL DIMENSIONS ARE IN METER UNLESS OTHERWISE STATED.
- HORIZONTAL AND VERTICAL CURVATURE OF SUCH ELASTIC BENDS SHOULD IDEALLY NOT BE LESS THAN A RADIUS OF 500M. WHERE THIS CANNOT BE OBTAINED, THE CURVATURE OF THE CONSTRUCTED FLOWLINE SHALL NOT BE LESS THAN 200M, UNLESS COST-SET ARE USE.
- IF A LONGITUDINAL WELD IS PRESENT IN THE FLOWLINE PIPE, THE LONGITUDINAL WELD SHALL BE IN THE NEUTRAL ZONE, LOCATED AT AN ANGLE OF APPROXIMATELY 10 DEG TO THE CENTERLINE OF THE PIPE PERPENDICULAR TO THE PLANE OF BENDING, AND AWAY FROM THE CENTER POINT OF THE RADIUS.
- ALL DIMENSIONS, ELEVATIONS AND ORIENTATIONS TO BE VERIFIED BY THE CONTRACTOR BEFORE UNDERTAKING ANY KIND OF FABRICATION, CONSTRUCTION AND INSTALLATION WORK AT SITE.
- FOR RISERS DETAIL SEE DRAWING # 2664-DT-002 & 2664-DT-003.

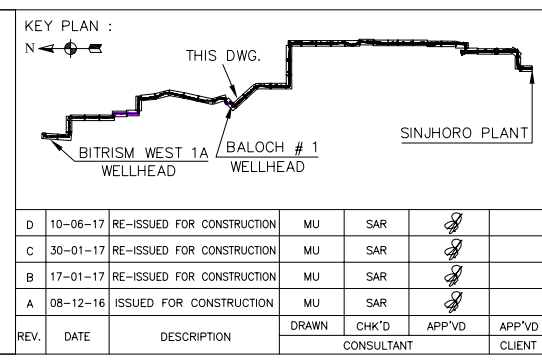

PC PETROCHEMICAL ENGINEERING CONSULTANTS
 C-2, BLOCK NO. 17, GULSHAN-E-IOBAN, NEAR NATIONAL STADIUM, KARACHI-75300, PAKISTAN.
 TEL: +92 (21) 34827780, 34961088, FAX: +92 21 34961089, E-Mail: contact@pec.com.pk web site: www.pec.com.pk

CLIENT: **OIL & GAS DEVELOPMENT COMPANY LTD.**

PROJECT: **DEVELOPMENT OF BITRISM WEST 1A**

TITLE: **PIPELINE ALIGNMENT DRAWING (12+000 TO 12+750)**

DRAWING NO. **2664-PL-017** SCALE: **1:2000** SHEET: **1 OF 1**

V. SCALE: **1:1000** SHEET: **A3**

RE-ISSUED FOR CONSTRUCTION

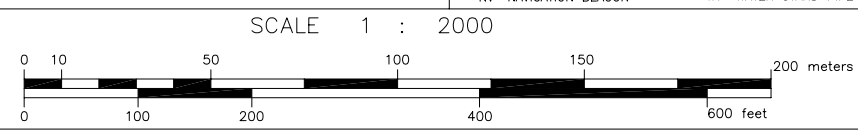

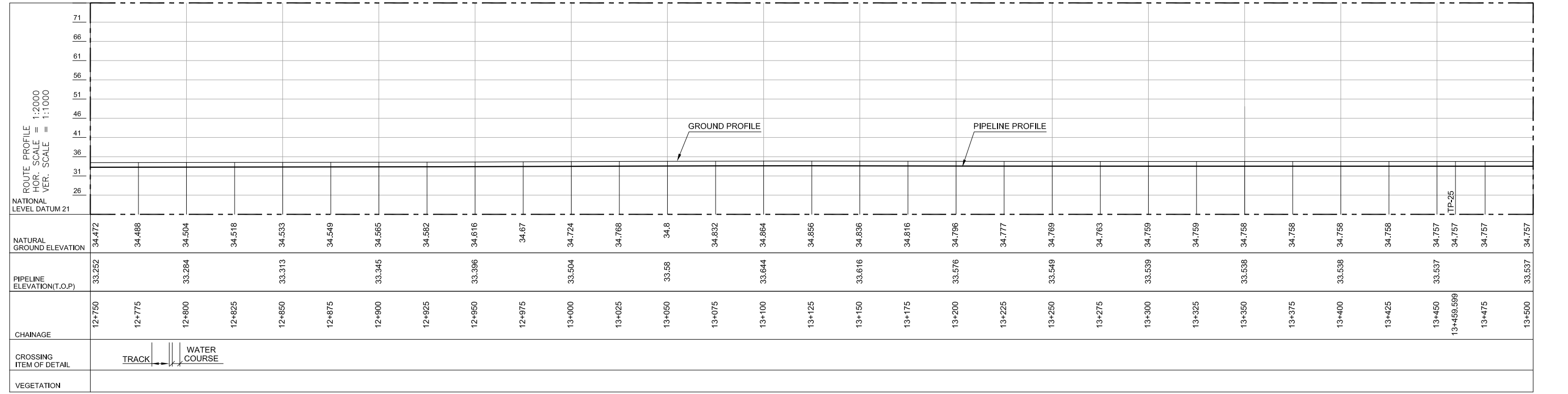
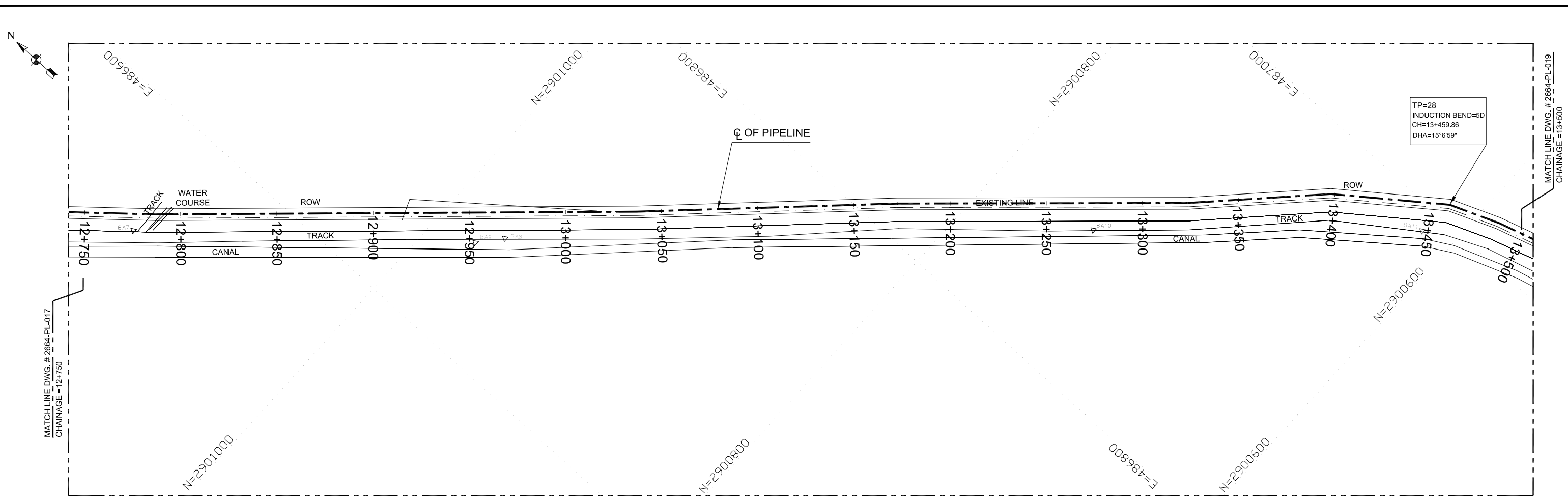

CONTROL:

SECONDARY SURVEY STATION (GPS)

TP TURNING POINT

LINE PIPE	8 INCH DIA, Sch. 80, CS, API 5L GR.X52.
LINE PIPE INSULATION	THREE LAYER POLYETHYLENE COATED
SPECIFICATION / CLASS	-
FLANGE RATING	CLASS 900# , RF
SERVICE LIMIT	-25 TO 150°F
HYDRO TEST PRESSURE	2250 PSIG.
SOIL COVER MIN.	4 ft

LEGEND :

RIVER / CANAL / DITCH	---
SURFACED ROAD	---
UNSURFACED ROAD	---
TRACK / PLATFORM	---
BANCH MARK	●
FENCE	---
PIPELINE PROFILE	---
ELECTRIC LINE	---
CUTTING AREA	---
GROUND PROFILE	---
TREE (NON FRUIT)	⊙
MAJOR CONTOUR	---
MINOR CONTOUR	---
TOP OF HILL	---
TOE OF HILL	---
VALVE	---
WATER LINE	---
FILLING AREA	---

ABBREVIATIONS:

AT	RADIO ANTENNA	PL	PIPELINE MARKER
CTM	BOUNDARY MARKER	PY	ELECTRICITY PYLON
BP	CATHODIC MARKER	RL	RUNWAY LIGHTS
EP	ELECTRICITY POLE	RM	RAILWAY MARKERS
FL	FLARE	SG	SIGNAL
KM	KILOMETER MARKER	SH	SEISMIC SHOT HOLE
LP	LAMP POST	SN	SIGN POST
LPM	LAND PARCEL MARKER	ST	SETTING OUT MARKER
MS	MAST	TP	TELEPHONE POLE
NV	NAVIGATION BEACON	WT	WATER STAND PIPE

NOTES :

- ALL DIMENSIONS ARE IN METER UNLESS OTHERWISE STATED.
- HORIZONTAL AND VERTICAL CURVATURE OF SUCH ELASTIC BENDS SHOULD IDEALLY NOT BE LESS THAN A RADIUS OF 500M. WHERE THIS CANNOT BE OBTAINED, THE CURVATURE OF THE CONSTRUCTED FLOWLINE SHALL NOT BE LESS THAN 200M, UNLESS COST-SET ARE USE.
- IF A LONGITUDINAL WELD IS PRESENT IN THE FLOWLINE PIPE, THE LONGITUDINAL WELD SHALL BE IN THE NEUTRAL ZONE, LOCATED AT AN ANGLE OF APPROXIMATELY 10 DEG TO THE CENTERLINE OF THE PIPE PERPENDICULAR TO THE PLANE OF BENDING, AND AWAY FROM THE CENTER POINT OF THE RADIUS.
- ALL DIMENSIONS, ELEVATIONS AND ORIENTATIONS TO BE VERIFIED BY THE CONTRACTOR BEFORE UNDERTAKING ANY KIND OF FABRICATION, CONSTRUCTION AND INSTALLATION WORK AT SITE.
- FOR RISERS DETAIL SEE DRAWING # 2664-DT-002 & 2664-DT-003.

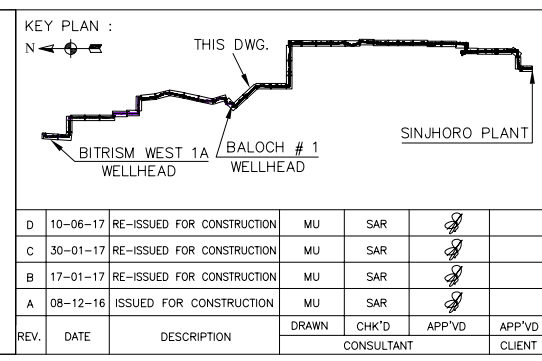

PC PETROCHEMICAL ENGINEERING CONSULTANTS
 C-2, BLOCK NO. 17, GULSHAN-E-IOQBAL, NEAR NATIONAL STADIUM, KARACHI-75300, PAKISTAN.
 TEL: +92 (21) 34827780, 34961088, FAX: +92 21 34961089, E-Mail: contact@pec.com.pk web site: www.pec.com.pk

CLIENT OIL & GAS DEVELOPMENT COMPANY LTD.

PROJECT DEVELOPMENT OF BITRISM WEST 1A

TITLE PIPELINE ALIGNMENT DRAWING (12+750 TO 13+500)

D	10-06-17	RE-ISSUED FOR CONSTRUCTION	MU	SAR		
C	30-01-17	RE-ISSUED FOR CONSTRUCTION	MU	SAR		
B	17-01-17	RE-ISSUED FOR CONSTRUCTION	MU	SAR		
A	08-12-16	ISSUED FOR CONSTRUCTION	MU	SAR		

REV.	DATE	DESCRIPTION	DRAWN	CHK'D	APP'VD	APP'VD
					CONSULTANT	CLIENT

DRAWING NO. 2664-PL-018

SCALE H. SCALE:1/2000 V. SCALE:1/1000

SHEET 1 OF 1 A3

RE-ISSUED FOR CONSTRUCTION

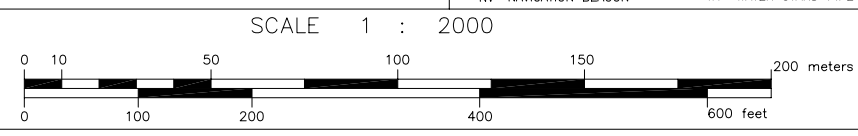

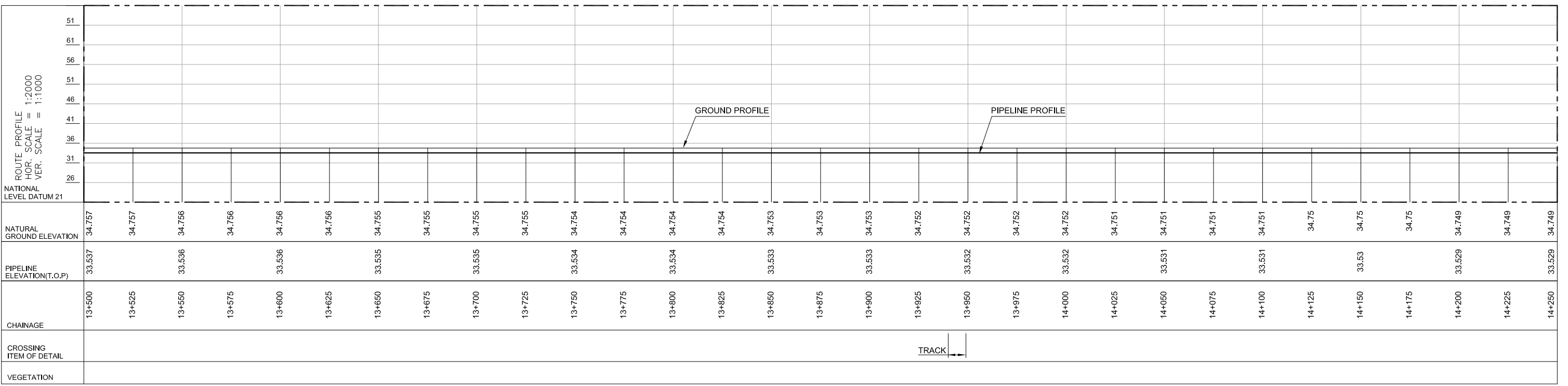
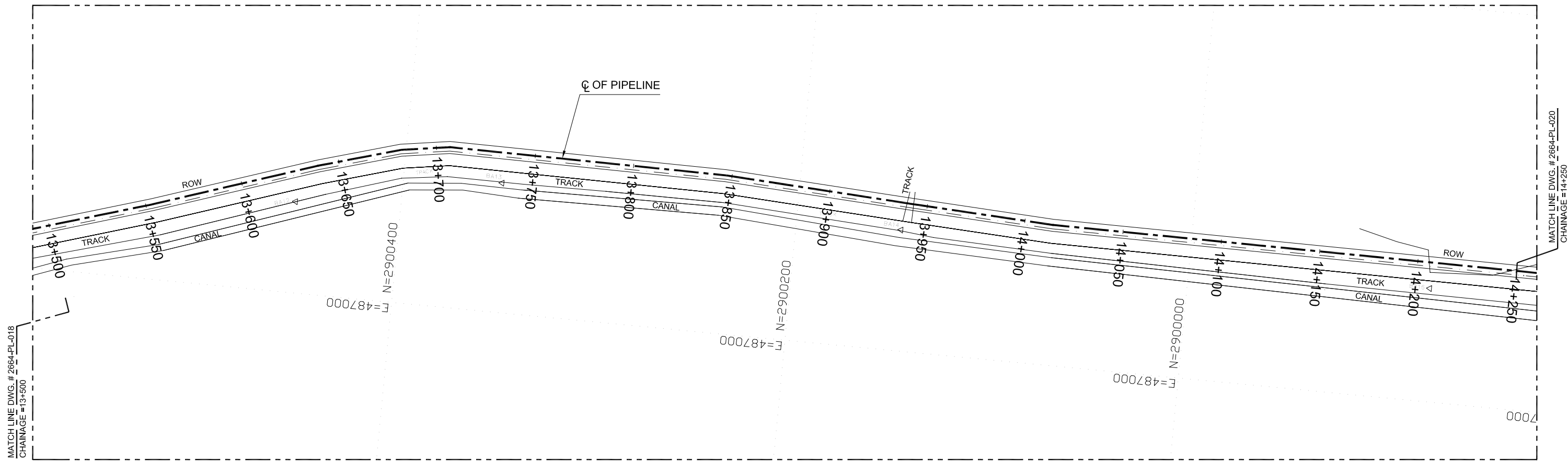

CONTROL:

SECONDARY SURVEY STATION (GPS)

TP TURNING POINT

LINE PIPE	8 INCH DIA, Sch. 80, CS, API 5L GR.X52.
LINE PIPE INSULATION	THREE LAYER POLYETHYLENE COATED
SPECIFICATION / CLASS	-
FLANGE RATING	CLASS 900# , RF
SERVICE LIMIT	-25 TO 150°F
HYDRO TEST PRESSURE	2250 PSIG.
SOIL COVER MIN.	4 ft

LEGEND :

RIVER / CANAL / DITCH	---
SURFACED ROAD	---
UNSURFACED ROAD	---
TRACK / PLATFORM	---
BANCH MARK	○
WALL	▬
FENCE	▬
PIPELINE PROFILE	---
ELECTRIC LINE	---
CUTTING AREA	▨

GROUND PROFILE	---
TREE (NON FRUIT)	⊙
MAJOR CONTOUR	---
MINOR CONTOUR	---
TOP OF HILL	▲
TOE OF HILL	▼
VALVE	▽
WATER LINE	---
FILLING AREA	▨

ABBREVIATIONS:

AT	RADIO ANTENNA	PL	PIPELINE MARKER
CTM	BOUNDARY MARKER	PY	ELECTRICITY PYLON
BP	CATHODIC MARKER	RL	RUNWAY LIGHTS
EP	ELECTRICITY POLE	RM	RAILWAY MARKERS
FL	FLARE	SG	SIGNAL
KM	KILOMETER MARKER	SH	SEISMIC SHOT HOLE
LP	LAMP POST	SN	SIGN POST
LPM	LAND PARCEL MARKER	ST	SETTING OUT MARKER
MS	MAST	TP	TELEPHONE POLE
NV	NAVIGATION BEACON	WT	WATER STAND PIPE

NOTES :

- ALL DIMENSIONS ARE IN METER UNLESS OTHERWISE STATED.
- HORIZONTAL AND VERTICAL CURVATURE OF SUCH ELASTIC BENDS SHOULD IDEALLY NOT BE LESS THAN A RADIUS OF 500M. WHERE THIS CANNOT BE OBTAINED, THE CURVATURE OF THE CONSTRUCTED FLOWLINE SHALL NOT BE LESS THAN 200M, UNLESS COST-SET ARE USE.
- IF A LONGITUDINAL WELD IS PRESENT IN THE FLOWLINE PIPE, THE LONGITUDINAL WELD SHALL BE IN THE NEUTRAL ZONE, LOCATED AT AN ANGLE OF APPROXIMATELY 10 DEG TO THE CENTERLINE OF THE PIPE PERPENDICULAR TO THE PLANE OF BENDING, AND AWAY FROM THE CENTER POINT OF THE RADIUS.
- ALL DIMENSIONS, ELEVATIONS AND ORIENTATIONS TO BE VERIFIED BY THE CONTRACTOR BEFORE UNDERTAKING ANY KIND OF FABRICATION, CONSTRUCTION AND INSTALLATION WORK AT SITE.
- FOR RISERS DETAIL SEE DRAWING # 2664-DT-002 & 2664-DT-003.

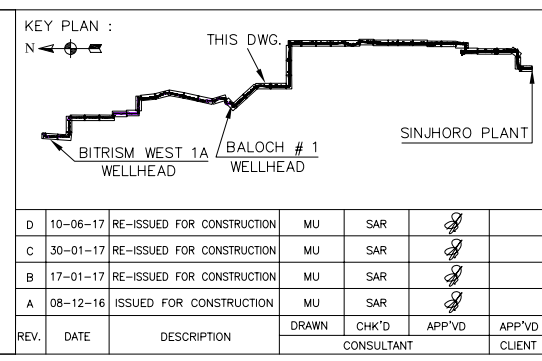

PC PETROCHEMICAL ENGINEERING CONSULTANTS
 C-2, BLOCK NO. 17, GULSHAN-E-IOBAL, NEAR NATIONAL STADIUM, KARACHI-75300, PAKISTAN.
 TEL: +92 (21) 34827780, 34961088, FAX: +92 21 34961089, E-Mail: contact@pec.com.pk web site: www.pec.com.pk

CLIENT OIL & GAS DEVELOPMENT COMPANY LTD.

PROJECT DEVELOPMENT OF BITRISM WEST 1A

TITLE PIPELINE ALIGNMENT DRAWING (13+500 TO 14+250)

DRAWING NO. 2664-PL-019

SCALE H. SCALE:1/2000 V. SCALE:1/1000

SHEET 1 OF 1 A3

RE-ISSUED FOR CONSTRUCTION

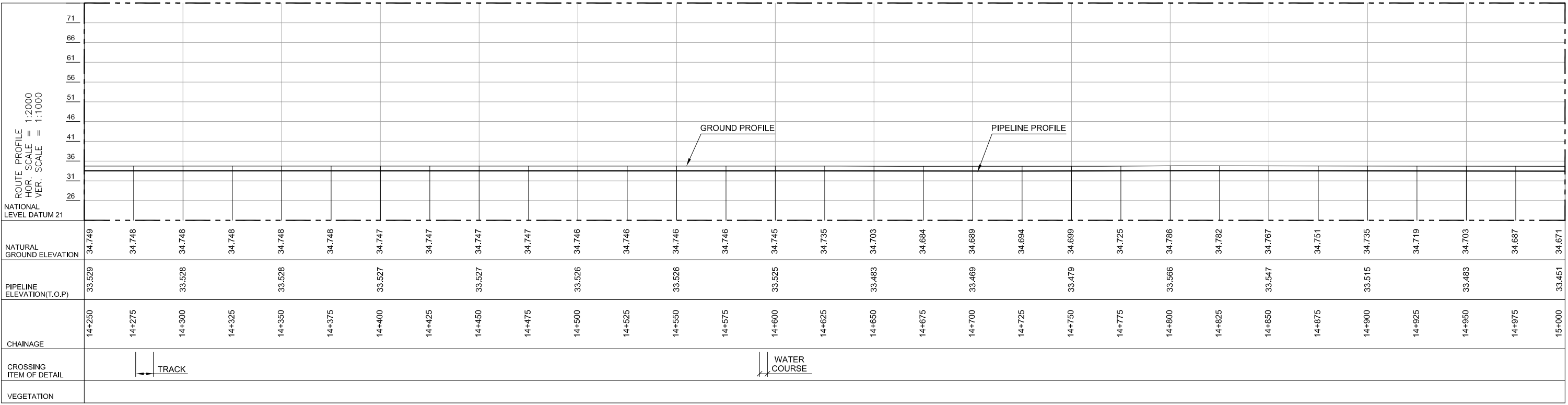
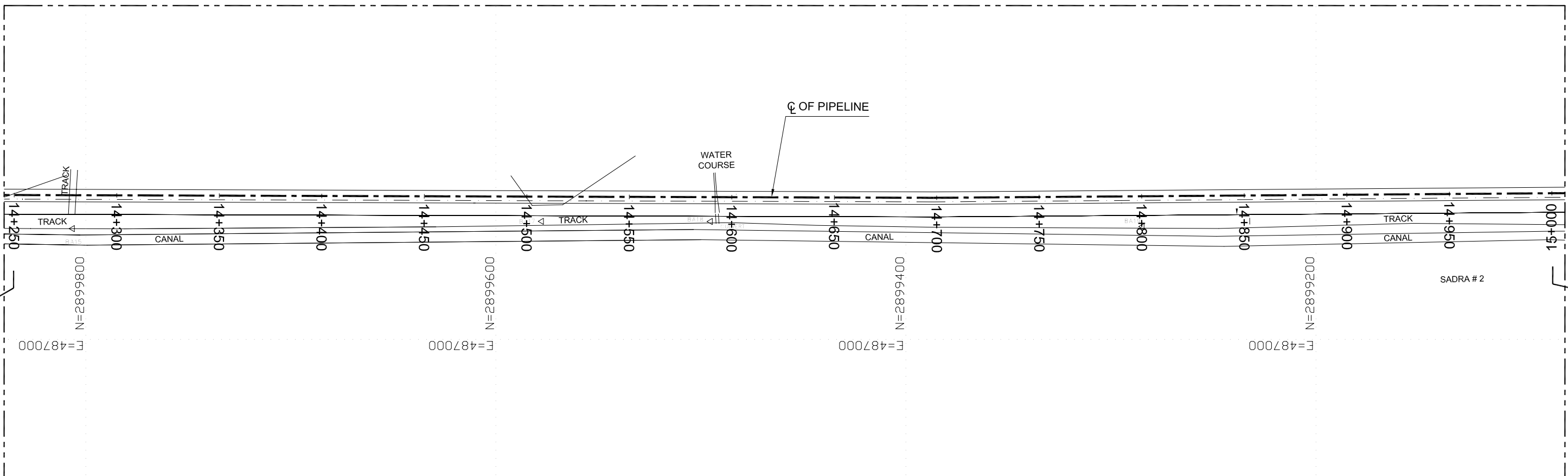
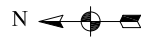

CONTROL:

SECONDARY SURVEY STATION (GPS)

TP TURNING POINT

LINE PIPE	8 INCH DIA, Sch. 80, CS, API 5L GR.X52.
LINE PIPE INSULATION	THREE LAYER POLYETHYLENE COATED
SPECIFICATION / CLASS	-
FLANGE RATING	CLASS 900# , RF
SERVICE LIMIT	-25 TO 150°F
HYDRO TEST PRESSURE	1800 PSIG.
SOIL COVER MIN.	4 ft

LEGEND :

RIVER / CANAL / DITCH	---
SURFACED ROAD	---
UNSURFACED ROAD	---
TRACK / PLATFORM	---
BENCH MARK	●
WALL	---
FENCE	---
PIPELINE PROFILE	---
ELECTRIC LINE	---
CUTTING AREA	▨

GROUND PROFILE

TREE (NON FRUIT)	⊙
MAJOR CONTOUR	~
MINOR CONTOUR	~
TOP OF HILL	▲
TOE OF HILL	▼
VALVE	⊠
WATER LINE	---
FILLING AREA	▨

ABBREVIATIONS:

AT	RADIO ANTENNA	PL	PIPELINE MARKER
CTM	BOUNDARY MARKER	PY	ELECTRICITY PYLON
BP	CATHODIC MARKER	RL	RUNWAY LIGHTS
EP	ELECTRICITY POLE	RM	RAILWAY MARKERS
FL	FLARE	SG	SIGNAL
KM	KILOMETER MARKER	SH	SEISMIC SHOT HOLE
LP	LAMP POST	SN	SIGN POST
LPM	LAND PARCEL MARKER	ST	SETTING OUT MARKER
MS	MAST	TP	TELEPHONE POLE
NV	NAVIGATION BEACON	WT	WATER STAND PIPE

NOTES :

- ALL DIMENSIONS ARE IN METER UNLESS OTHERWISE STATED.
- HORIZONTAL AND VERTICAL CURVATURE OF SUCH ELASTIC BENDS SHOULD IDEALLY NOT BE LESS THAN A RADIUS OF 500M. WHERE THIS CANNOT BE OBTAINED, THE CURVATURE OF THE CONSTRUCTED FLOWLINE SHALL NOT BE LESS THAN 200M, UNLESS OTHERWISE STATED.
- IF A LONGITUDINAL WELD IS PRESENT IN THE FLOWLINE PIPE, THE LONGITUDINAL WELD SHALL BE IN THE NEUTRAL ZONE, LOCATED AT AN ANGLE OF APPROXIMATELY 10 DEG TO THE CENTERLINE OF THE PIPE PERPENDICULAR TO THE PLANE OF BENDING, AND AWAY FROM THE CENTER POINT OF THE RADIUS.
- ALL DIMENSIONS, ELEVATIONS AND ORIENTATIONS TO BE VERIFIED BY THE CONTRACTOR BEFORE UNDERTAKING ANY KIND OF FABRICATION, CONSTRUCTION AND INSTALLATION WORK AT SITE.
- FOR RISERS DETAIL SEE DRAWING # 2664-DT-002 & 2664-DT-003.

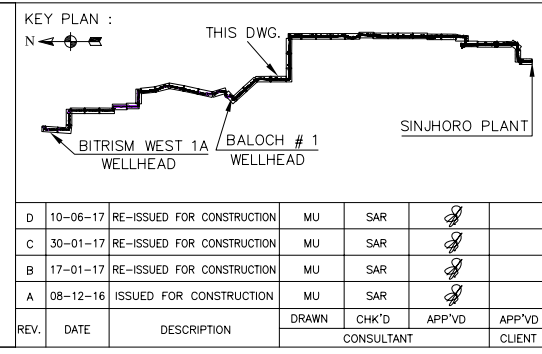

PC PETROCHEMICAL ENGINEERING CONSULTANTS
 C-2, BLOCK NO. 17, GULSHAN-E-IOBAL, NEAR NATIONAL STADIUM, KARACHI-75300, PAKISTAN.
 TEL: +92 (21) 34827780, 34961088, FAX: +92 21 34961089, E-Mail: contact@pec.com.pk web site: www.pec.com.pk

CLIENT OIL & GAS DEVELOPMENT COMPANY LTD.

PROJECT DEVELOPMENT OF BITRISM WEST 1A

TITLE PIPELINE ALIGNMENT DRAWING (14+250 TO 15+000)

DRAWING NO. 2664-PL-020

SCALE H. SCALE:1/2000
V. SCALE:1/1000

SHEET 1 OF 1
A3

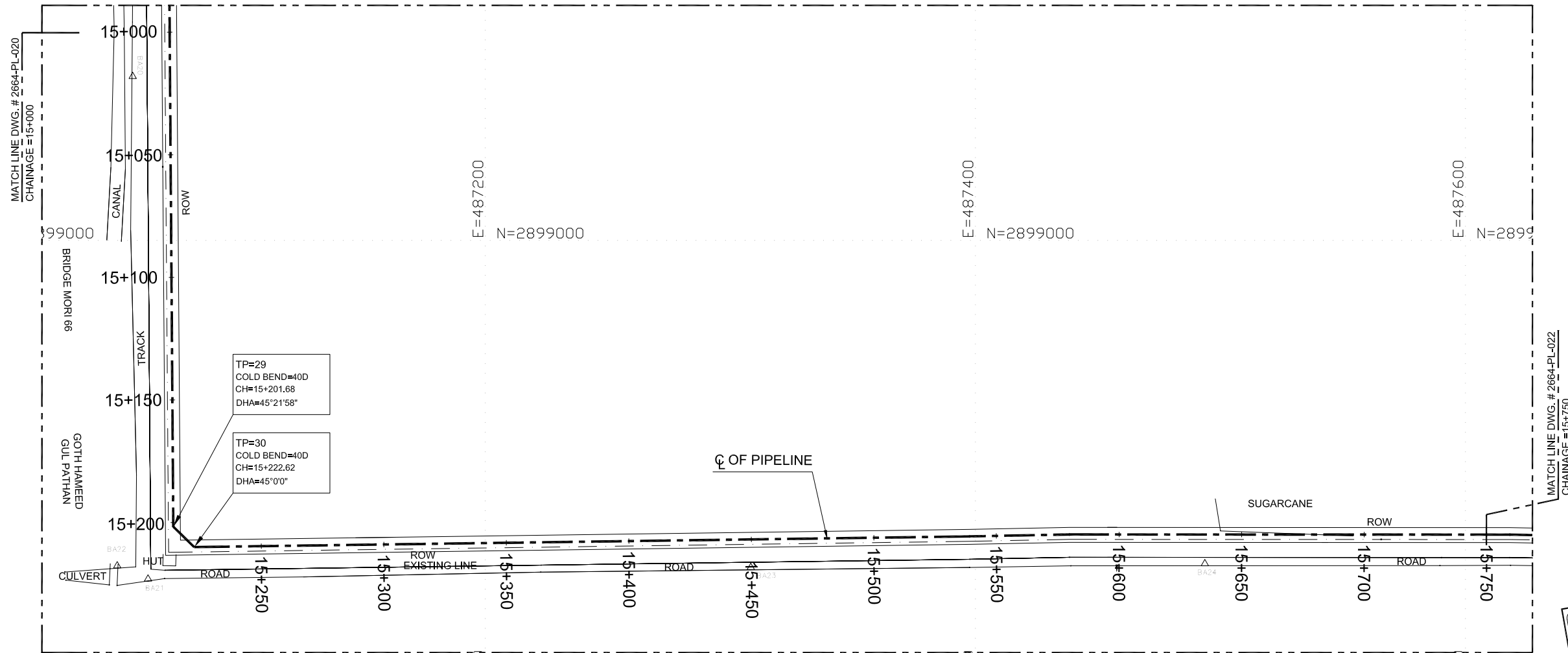

RE-ISSUED FOR CONSTRUCTION

NATIONAL LEVEL DATUM 21	ROUTE PROFILE HOR. SCALE = 1:2000 VER. SCALE = 1:1000																																		
	GROUND PROFILE	PIPELINE PROFILE																																	
NATURAL GROUND ELEVATION	34.671	34.655	34.639	34.636	34.663	34.691	34.718	34.746	34.752	34.748	34.713	34.711	34.67	34.631	34.594	34.601	34.62	34.599	34.608	34.607	34.52	34.461	34.492	34.523	34.554	34.597	34.664	34.661	34.659	34.656	34.653	34.651	34.648		
PIPELINE ELEVATION(T.O.P)	33.171		33.139		33.163		33.218		33.252		33.17		33.094		33.12		33.108		33.02		32.992		33.064		33.164		33.159		33.153		33.148				
CHAINAGE	15+000	15+025	15+050	15+075	15+100	15+125	15+150	15+175	15+200	15+202.31	15+223.54	15+225	15+250	15+275	15+300	15+325	15+350	15+375	15+400	15+425	15+450	15+475	15+500	15+525	15+550	15+575	15+600	15+625	15+650	15+675	15+700	15+725	15+750		
CROSSING ITEM OF DETAIL																																			
VEGETATION																																			

CONTROL:	
SECONDARY SURVEY STATION (GPS)	
TP TURNING POINT	
LINE PIPE	8 INCH DIA, Sch. 80, CS, API 5L GR.X52
LINE PIPE INSULATION	THREE LAYER POLYETHYLENE COATED
SPECIFICATION / CLASS	-
FLANGE RATING	CLASS 900# , RF
SERVICE LIMIT	-25 TO 150°F
HYDRO TEST PRESSURE	2250 PSIG.
SOIL COVER MIN.	4 ft

LEGEND :	
RIVER / CANAL / DITCH	
SURFACED ROAD	
UNSURFACED ROAD	
TRACK / PLATFORM	
BENCH MARK	
WALL	
FENCE	
PIPELINE PROFILE	
ELECTRIC LINE	
CUTTING AREA	
GROUND PROFILE	
TREE (NON FRUIT)	
MAJOR CONTOUR	
MINOR CONTOUR	
TOP OF HILL	
TOE OF HILL	
VALVE	
WATER LINE	
FILLING AREA	

ABBREVIATIONS:	
AT RADIO ANTENNA	PL PIPELINE MARKER
CTM BOUNDARY MARKER	PY ELECTRICITY PYLON
BP CATHODIC MARKER	RL RUNWAY LIGHTS
EP ELECTRICITY POLE	RM RAILWAY MARKERS
FL FLARE	SG SIGNAL
KM KILOMETER MARKER	SH SEISMIC SHOT HOLE
LP LAMP POST	SN SIGN POST
LPM LAND PARCEL MARKER	ST SETTING OUT MARKER
MS MAST	TP TELEPHONE POLE
NV NAVIGATION BEACON	WT WATER STAND PIPE

NOTES :

- ALL DIMENSIONS ARE IN METER UNLESS OTHERWISE STATED.
- HORIZONTAL AND VERTICAL CURVATURE OF SUCH ELASTIC BENDS SHOULD IDEALLY NOT BE LESS THAN A RADIUS OF 500M. WHERE THIS CANNOT BE OBTAINED, THE CURVATURE OF THE CONSTRUCTED FLOWLINE SHALL NOT BE LESS THAN 200M, UNLESS COST-SET ARE USE.
- COLD-SET BENDS SHALL BE OF UNIFORM RADIUS, AND MINIMUM RADIUS OF CURVATURE SHALL BE 40X LINE PIPE DIAMETER.
- ALL COLD-SET BENDS SHALL BE TESTED BY THE CONTRACTOR AND WITNESS BY THE COMPANY, WITH A CALLIPER OF 97.5% OF THE NOMINAL INTERNAL DIAMETER PRIOR TO INSTALLATION.
- IF A LONGITUDINAL WELD IS PRESENT IN THE FLOWLINE PIPE, THE LONGITUDINAL WELD SHALL BE IN THE NEUTRAL ZONE, LOCATED AT AN ANGLE OF APPROXIMATELY 10 DEG TO THE CENTERLINE OF THE PIPE PERPENDICULAR TO THE PLANE OF BENDING, AND AWAY FROM THE CENTER POINT OF THE RADIUS.
- COLD-SET BENDS SHALL NOT BE MADE CLOSER THAN 2000mm FROM A CIRCUMFERENTIAL WELD. THE END OF EACH BEND SHALL BE STRAIGHT FOR AT LEAST 2000mm. THE CONTRACTOR SHALL LAYOUT AND MEASURE THE FLOWLINE PIPE FOR BENDING, TO KEEP THE LENGTH OF CUT-OFF TO A MINIMUM.
- ALL DIMENSIONS, ELEVATIONS AND ORIENTATIONS TO BE VERIFIED BY THE CONTRACTOR BEFORE UNDERTAKING ANY KIND OF FABRICATION, CONSTRUCTION AND INSTALLATION WORK AT SITE.
- FOR COLD BENDS DETAIL SEE DRAWING # 2664-DT-001.
- FOR RISERS DETAIL SEE DRAWING # 2664-DT-002 & 2664-DT-003.

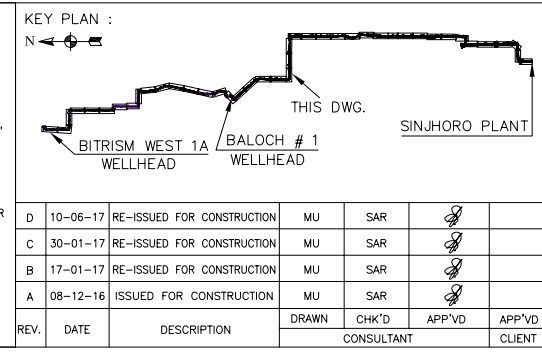

PC PETROCHEMICAL ENGINEERING CONSULTANTS
 C-2, BLOCK NO. 17, GULSHAN-E-IOBAL, NEAR NATIONAL STADIUM, KARACHI-75300, PAKISTAN.
 TEL: +92 (21) 34827780, 34961088, FAX: +92 21 34961089, E-Mail: contact@pec.com.pk web site: www.pec.com.pk

CLIENT
 OIL & GAS DEVELOPMENT COMPANY LTD.

PROJECT
 DEVELOPMENT OF BITRISM WEST 1A

TITLE
 PIPELINE ALIGNMENT DRAWING
 (15+000 TO 15+750)

DRAWING NO.	SCALE	SHEET
2664-PL-021	H. SCALE:1/2000 V. SCALE:1/1000	1 OF 1 A3

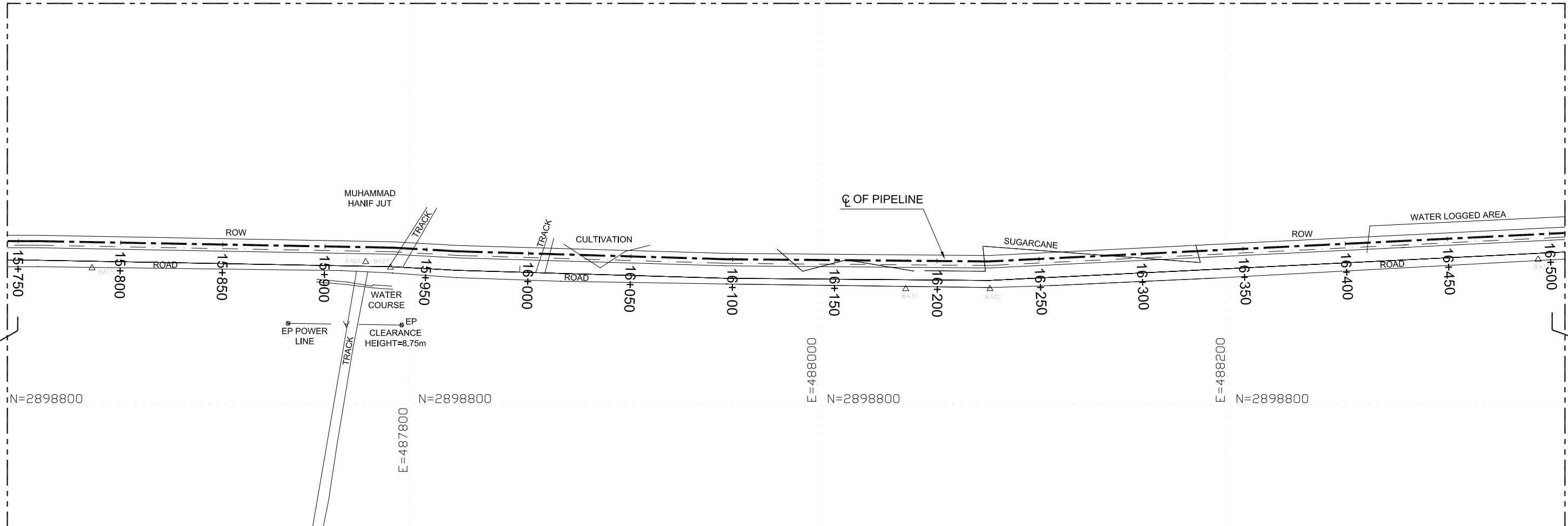

NATIONAL LEVEL DATUM 21	ROUTE PROFILE HOR. SCALE = 1:2000 VER. SCALE = 1:1000																														
	GROUND PROFILE	PIPELINE PROFILE																													
NATURAL GROUND ELEVATION	34.648	34.694	34.766	34.738	34.778	34.886	34.867	34.832	34.761	34.614	34.467	34.334	34.26	34.08	33.921	33.916	33.912	33.907	33.903	33.899	33.894	33.89	33.885	33.881	33.876	33.872	33.867	33.863	33.858	33.854	33.849
PIPELINE ELEVATION(T.O.P)	33.428	33.546	33.558	33.647	33.541	33.247	33.04	32.701	32.692	32.683	32.674	32.665	32.656	32.647	32.638	32.629															
CHAINAGE	15+750	15+775	15+800	15+825	15+850	15+875	15+900	15+925	15+950	15+975	16+000	16+025	16+050	16+075	16+100	16+125	16+150	16+175	16+200	16+225	16+250	16+275	16+300	16+325	16+350	16+375	16+400	16+425	16+450	16+475	16+500
CROSSING ITEM OF DETAIL	TRACK																														
VEGETATION																															

CONTROL:

SECONDARY SURVEY STATION (GPS)

TP TURNING POINT

LINE PIPE	8 INCH DIA, Sch. 80, CS, API 5L GR.X52.
LINE PIPE INSULATION	THREE LAYER POLYETHYLENE COATED
SPECIFICATION / CLASS	-
FLANGE RATING	CLASS 900# , RF
SERVICE LIMIT	-25 TO 150°F
HYDRO TEST PRESSURE	2250 PSIG.
SOIL COVER MIN.	4 ft

LEGEND :

RIVER / CANAL / DITCH		GROUND PROFILE	
SURFACED ROAD		TREE (NON FRUIT)	
UNSURFACED ROAD		MAJOR CONTOUR	
TRACK / PLATFORM		MINOR CONTOUR	
BENCH MARK		TOP OF HILL	
WALL		TOE OF HILL	
FENCE		VALVE	
PIPELINE PROFILE		WATER LINE	
ELECTRIC LINE		FILLING AREA	
CUTTING AREA			

ABBREVIATIONS:

AT	RADIO ANTENNA	PL	PIPELINE MARKER
CTM	BOUNDARY MARKER	PY	ELECTRICITY PYLON
BP	CATHODIC MARKER	RM	RUNWAY LIGHTS
EP	ELECTRICITY POLE	RL	RAILWAY MARKERS
FL	FLARE	SG	SIGNAL
KM	KILOMETER MARKER	SH	SEISMIC SHOT HOLE
LP	LAMP POST	SN	SIGN POST
LPM	LAND PARCEL MARKER	ST	SETTING OUT MARKER
MS	MAST	TP	TELEPHONE POLE
NV	NAVIGATION BEACON	WT	WATER STAND PIPE

NOTES :

- ALL DIMENSIONS ARE IN METER UNLESS OTHERWISE STATED.
- HORIZONTAL AND VERTICAL CURVATURE OF SUCH ELASTIC BENDS SHOULD IDEALLY NOT BE LESS THAN A RADIUS OF 500M. WHERE THIS CANNOT BE OBTAINED, THE CURVATURE OF THE CONSTRUCTED FLOWLINE SHALL NOT BE LESS THAN 200M, UNLESS COST-SET ARE USE.
- IF A LONGITUDINAL WELD IS PRESENT IN THE FLOWLINE PIPE, THE LONGITUDINAL WELD SHALL BE IN THE NEUTRAL ZONE, LOCATED AT AN ANGLE OF APPROXIMATELY 10 DEG TO THE CENTERLINE OF THE PIPE PERPENDICULAR TO THE PLANE OF BENDING, AND AWAY FROM THE CENTER POINT OF THE RADIUS.
- ALL DIMENSIONS, ELEVATIONS AND ORIENTATIONS TO BE VERIFIED BY THE CONTRACTOR BEFORE UNDERTAKING ANY KIND OF FABRICATION, CONSTRUCTION AND INSTALLATION WORK AT SITE.
- FOR RISERS DETAIL SEE DRAWING # 2664-DT-002 & 2664-DT-003.

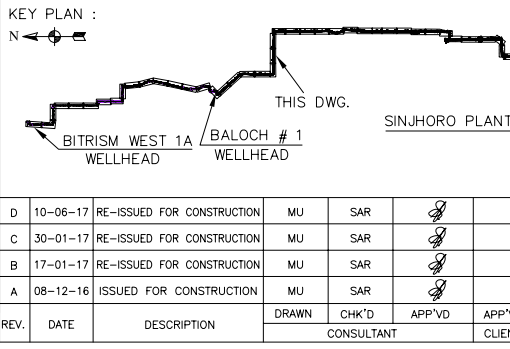

PC PETROCHEMICAL ENGINEERING CONSULTANTS
 C-2, BLOCK NO. 17, GULSHAN-E-IOBAL, NEAR NATIONAL STADIUM, KARACHI-75300, PAKISTAN.
 TEL: +92 (21) 34827780, 34961088, FAX: +92 21 34961089, E-Mail: contact@pec.com.pk web site: www.pec.com.pk

CLIENT
 OIL & GAS DEVELOPMENT COMPANY LTD.

PROJECT
 DEVELOPMENT OF BITRISM WEST 1A

TITLE
 PIPELINE ALIGNMENT DRAWING
 (15+750 TO 16+500)

D	10-06-17	RE-ISSUED FOR CONSTRUCTION	MU	SAR			
C	30-01-17	RE-ISSUED FOR CONSTRUCTION	MU	SAR			
B	17-01-17	RE-ISSUED FOR CONSTRUCTION	MU	SAR			
A	08-12-16	ISSUED FOR CONSTRUCTION	MU	SAR			
REV.	DATE	DESCRIPTION	DRAWN	CHK'D	APP'VD	APP'VD	
					CONSULTANT	CLIENT	

DRAWING NO. 2664-PL-022

SCALE H. SCALE:1/2000
V. SCALE:1/1000

SHEET 1 OF 1
A3

RE-ISSUED FOR CONSTRUCTION

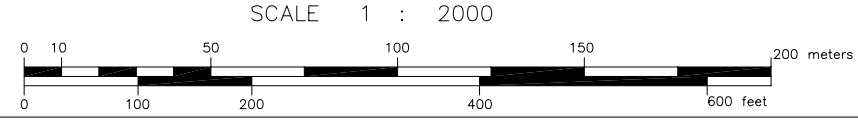

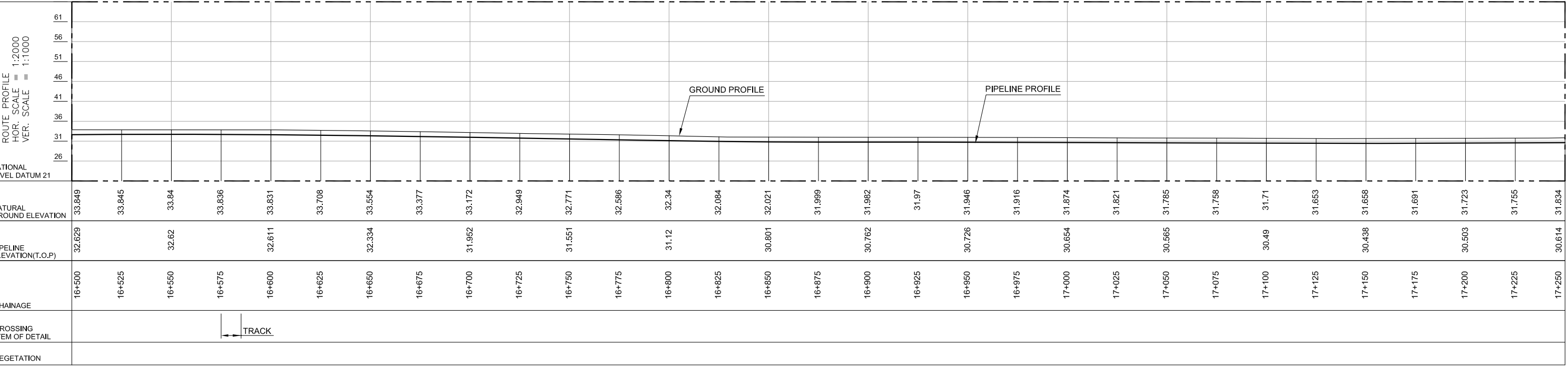
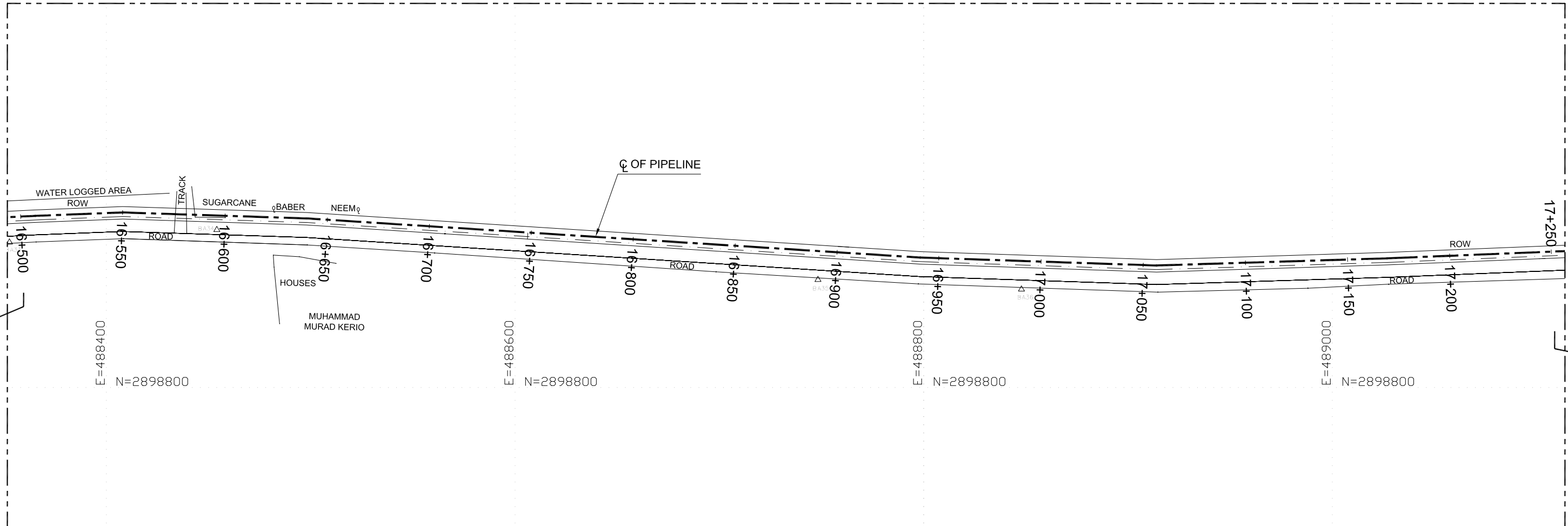

CONTROL:

SECONDARY SURVEY STATION (GPS)

TP TURNING POINT

LINE PIPE	8 INCH DIA, Sch. 80, CS, API 5L GR.X52.
LINE PIPE INSULATION	THREE LAYER POLYETHYLENE COATED
SPECIFICATION / CLASS	-
FLANGE RATING	CLASS 900# , RF
SERVICE LIMIT	-25 TO 150°F
HYDRO TEST PRESSURE	2250 PSIG.
SOIL COVER MIN.	4 ft

LEGEND :

RIVER / CANAL / DITCH	---
SURFACED ROAD	---
UNSURFACED ROAD	---
TRACK / PLATFORM	---
BANCH MARK	●
WALL	---
FENCE	---
PIPELINE PROFILE	---
ELECTRIC LINE	---
CUTTING AREA	---
GROUND PROFILE	---
TREE (NON FRUIT)	⊙
MAJOR CONTOUR	---
MINOR CONTOUR	---
TOP OF HILL	▲
TOE OF HILL	▼
VALVE	△
WATER LINE	---
FILLING AREA	---

ABBREVIATIONS:

AT	RADIO ANTENNA	PL	PIPELINE MARKER
CTM	BOUNDARY MARKER	PY	ELECTRICITY PYLON
BP	CATHODIC MARKER	RM	RUNWAY LIGHTS
EP	ELECTRICITY POLE	RL	RAILWAY MARKERS
FL	FLARE	SG	SIGNAL
KM	KILOMETER MARKER	SH	SEISMIC SHOT HOLE
LP	LAMP POST	SN	SIGN POST
LPM	LAND PARCEL MARKER	ST	SETTING OUT MARKER
MS	MAST	TP	TELEPHONE POLE
NV	NAVIGATION BEACON	WT	WATER STAND PIPE

NOTES :

- ALL DIMENSIONS ARE IN METER UNLESS OTHERWISE STATED.
- HORIZONTAL AND VERTICAL CURVATURE OF SUCH ELASTIC BENDS SHOULD IDEALLY NOT BE LESS THAN A RADIUS OF 500M. WHERE THIS CANNOT BE OBTAINED, THE CURVATURE OF THE CONSTRUCTED FLOWLINE SHALL NOT BE LESS THAN 200M, UNLESS COST-SET ARE USE.
- IF A LONGITUDINAL WELD IS PRESENT IN THE FLOWLINE PIPE, THE LONGITUDINAL WELD SHALL BE IN THE NEUTRAL ZONE, LOCATED AT AN ANGLE OF APPROXIMATELY 10 DEG TO THE CENTERLINE OF THE PIPE PERPENDICULAR TO THE PLANE OF BENDING, AND AWAY FROM THE CENTER POINT OF THE RADIUS.
- ALL DIMENSIONS, ELEVATIONS AND ORIENTATIONS TO BE VERIFIED BY THE CONTRACTOR BEFORE UNDERTAKING ANY KIND OF FABRICATION, CONSTRUCTION AND INSTALLATION WORK AT SITE.
- FOR RISERS DETAIL SEE DRAWING # 2664-DT-002 & 2664-DT-003.

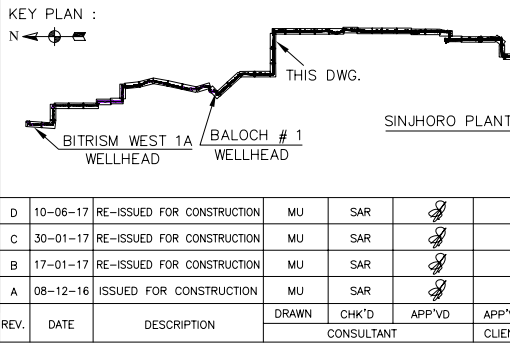

PC PETROCHEMICAL ENGINEERING CONSULTANTS
 C-2, BLOCK NO. 17, GULSHAN-E-IOBAL, NEAR NATIONAL STADIUM, KARACHI-75300, PAKISTAN.
 TEL: +92 (21) 34827780, 34961088, FAX: +92 21 34961089, E-Mail: contact@pec.com.pk web site: www.pec.com.pk

CLIENT
 OIL & GAS DEVELOPMENT COMPANY LTD.

PROJECT
 DEVELOPMENT OF BITRISM WEST 1A

TITLE
 PIPELINE ALIGNMENT DRAWING
 (16+500 TO 17+250)

D	10-06-17	RE-ISSUED FOR CONSTRUCTION	MU	SAR		
C	30-01-17	RE-ISSUED FOR CONSTRUCTION	MU	SAR		
B	17-01-17	RE-ISSUED FOR CONSTRUCTION	MU	SAR		
A	08-12-16	ISSUED FOR CONSTRUCTION	MU	SAR		

REV.	DATE	DESCRIPTION	DRAWN	CHK'D	APP'VD	APP'VD
					CONSULTANT	CLIENT

DRAWING NO. 2664-PL-023

SCALE: H. SCALE:1/2000 V. SCALE:1/1000

SHEET 1 OF 1 A3

RE-ISSUED FOR CONSTRUCTION

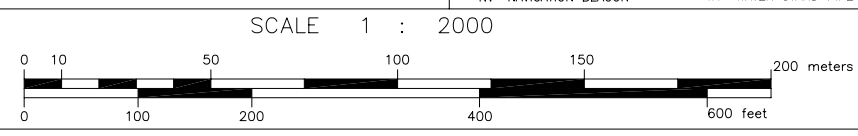

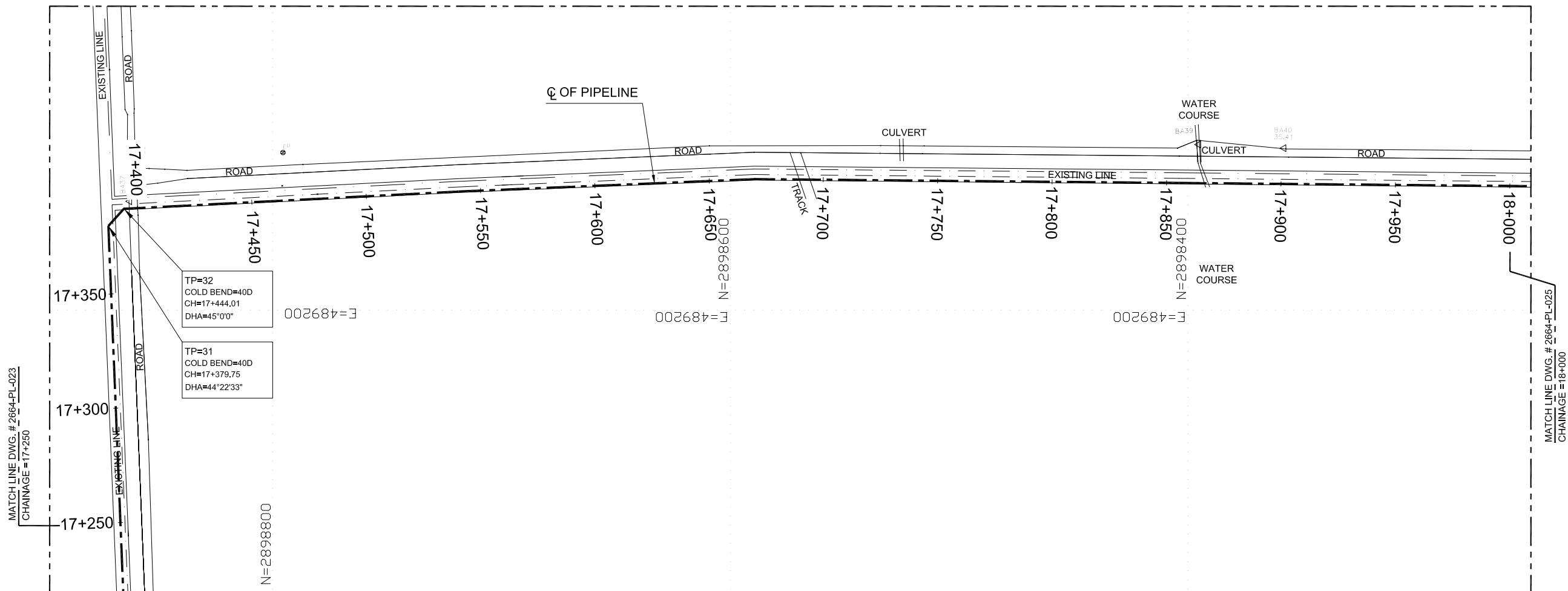

RE-ISSUED FOR CONSTRUCTION

NATIONAL LEVEL DATUM 21	ROUTE PROFILE HOR. SCALE = 1:2000 VER. SCALE = 1:1000	
	GROUND PROFILE	PIPELINE PROFILE
NATURAL GROUND ELEVATION	31.834	31.998
PIPELINE ELEVATION(T.O.P)	30.614	30.785
CHAINAGE	17+250	17+275
CROSSING ITEM OF DETAIL	ROAD	TRACK
VEGETATION		

CONTROL:

SECONDARY SURVEY STATION (GPS)

TP TURNING POINT

LINE PIPE	8 INCH DIA, Sch. 80, CS, API 5L GR.X52
LINE PIPE INSULATION	THREE LAYER POLYETHYLENE COATED
SPECIFICATION / CLASS	-
FLANGE RATING	CLASS 900# , RF
SERVICE LIMIT	-25 TO 150°F
HYDRO TEST PRESSURE	2250 PSIG.
SOIL COVER MIN.	4 ft

LEGEND :

RIVER / CANAL / DITCH	---
SURFACED ROAD	---
UNSURFACED ROAD	---
TRACK / PLATFORM	---
BENCH MARK	●
WALL	▬
FENCE	▬
PIPELINE PROFILE	---
ELECTRIC LINE	---
CUTTING AREA	▨

ABBREVIATIONS:

AT	RADIO ANTENNA	PL	PIPELINE MARKER
CTM	BOUNDARY MARKER	PY	ELECTRICITY PYLON
BP	CATHODIC MARKER	RL	RUNWAY LIGHTS
EP	ELECTRICITY POLE	RM	RAILWAY MARKERS
FL	FLARE	SG	SIGNAL
KM	KILOMETER MARKER	SH	SEISMIC SHOT HOLE
LP	LAMP POST	SN	SIGN POST
LPM	LAND PARCEL MARKER	ST	SETTING OUT MARKER
MS	MAST	TP	TELEPHONE POLE
NV	NAVIGATION BEACON	WT	WATER STAND PIPE

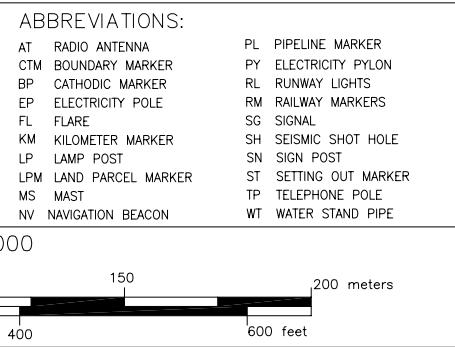

- NOTES :**
- ALL DIMENSIONS ARE IN METER UNLESS OTHERWISE STATED.
 - HORIZONTAL AND VERTICAL CURVATURE OF SUCH ELASTIC BENDS SHOULD IDEALLY NOT BE LESS THAN A RADIUS OF 500M. WHERE THIS CANNOT BE OBTAINED, THE CURVATURE OF THE CONSTRUCTED FLOWLINE SHALL NOT BE LESS THAN 200M, UNLESS COLD-SET ARE USE.
 - COLD-SET BENDS SHALL BE OF UNIFORM RADIUS, AND MINIMUM RADIUS OF CURVATURE SHALL BE 40xLINE PIPE DIAMETER.
 - ALL COLD-SET BENDS SHALL BE TESTED BY THE CONTRACTOR AND WITNESS BY THE COMPANY, WITH A CALLIPER OF 97.5% OF THE NOMINAL INTERNAL DIAMETER PRIOR TO INSTALLATION.
 - IF A LONGITUDINAL WELD IS PRESENT IN THE FLOWLINE PIPE, THE LONGITUDINAL WELD SHALL BE IN THE NEUTRAL ZONE, LOCATED AT AN ANGLE OF APPROXIMATELY 10 DEG TO THE CENTERLINE OF THE PIPE, PERPENDICULAR TO THE PLANE OF BENDING, AND AWAY FROM THE CENTER POINT OF THE RADIUS.
 - COLD-SET BENDS SHALL NOT BE MADE CLOSER THAN 2000mm FROM A CIRCUMFERENTIAL WELD. THE END OF EACH BEND SHALL BE STRAIGHT FOR AT LEAST 2000mm. THE CONTRACTOR SHALL LAYOUT AND MEASURE THE FLOWLINE PIPE FOR BENDING, TO KEEP THE LENGTH OF CUT-OFF TO A MINIMUM.
 - ALL DIMENSIONS, ELEVATIONS AND ORIENTATIONS TO BE VERIFIED BY THE CONTRACTOR BEFORE UNDERTAKING ANY KIND OF FABRICATION, CONSTRUCTION AND INSTALLATION WORK AT SITE.
 - FOR COLD BENDS DETAIL SEE DRAWING # 2664-DT-001.
 - FOR RISERS DETAIL SEE DRAWING # 2664-DT-002 & 2664-DT-003.

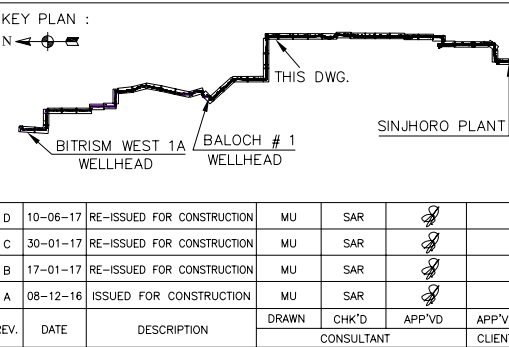

PC PETROCHEMICAL ENGINEERING CONSULTANTS
C-2, BLOCK NO. 17, GULSHAN-E-IOBAL, NEAR NATIONAL STADIUM, KARACHI-75300, PAKISTAN.
TEL: +92 (21) 34827780, 34961088, FAX: +92 21 34961089, E-Mail: contact@pec.com.pk web site: www.pec.com.pk

CLIENT: **OIL & GAS DEVELOPMENT COMPANY LTD.**

PROJECT: **DEVELOPMENT OF BITRISM WEST 1A**

TITLE: **PIPELINE ALIGNMENT DRAWING (17+250 TO 18+000)**

D	10-06-17	RE-ISSUED FOR CONSTRUCTION	MU	SAR	
C	30-01-17	RE-ISSUED FOR CONSTRUCTION	MU	SAR	
B	17-01-17	RE-ISSUED FOR CONSTRUCTION	MU	SAR	
A	08-12-16	ISSUED FOR CONSTRUCTION	MU	SAR	

REV.	DATE	DESCRIPTION	DRAWN	CHK'D	APP'VD	APP'VD
					CONSULTANT	CLIENT

DRAWING NO. **2664-PL-024** SCALE **H. SCALE:1/2000** SHEET **1 OF 1**
V. SCALE:1/1000 A3

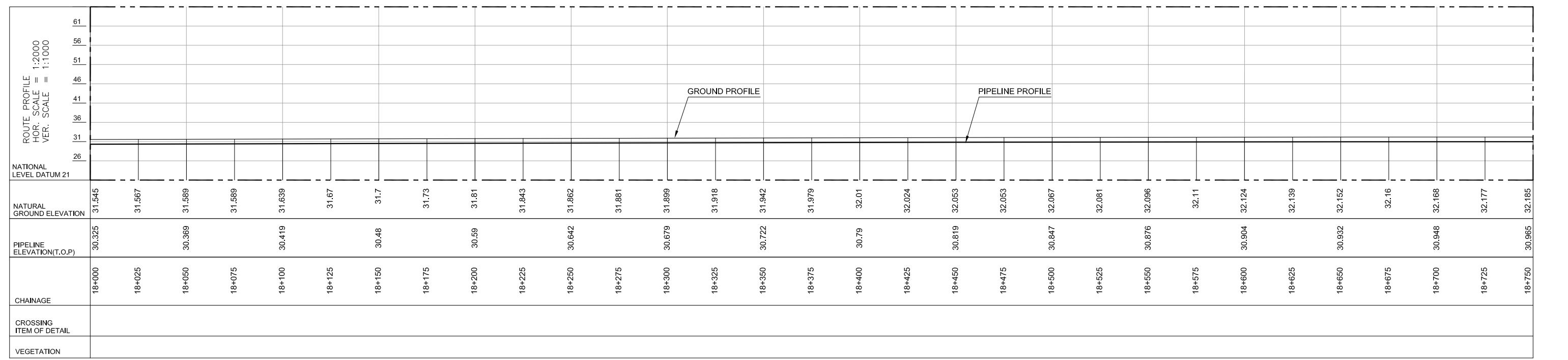
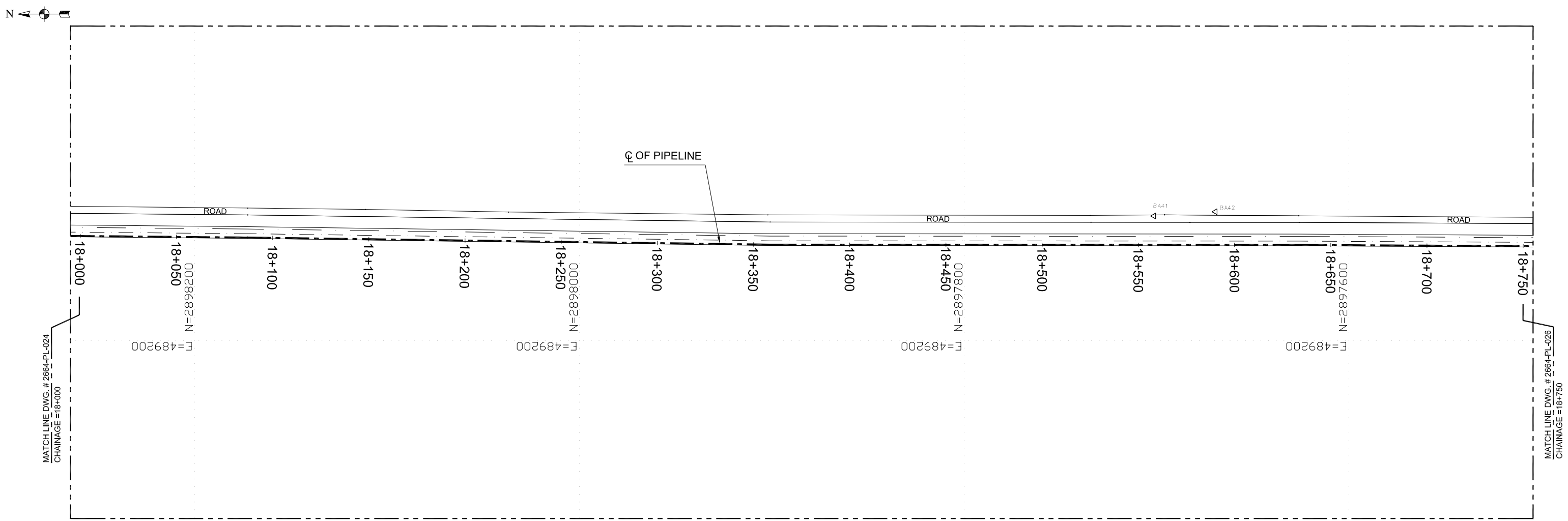

CONTROL:

SECONDARY SURVEY STATION (GPS)

TP TURNING POINT

LINE PIPE	8 INCH DIA, Sch. 80, CS, API 5L GR.X52.
LINE PIPE INSULATION	THREE LAYER POLYETHYLENE COATED
SPECIFICATION / CLASS	-
FLANGE RATING	CLASS 900# , RF
SERVICE LIMIT	-25 TO 150°F
HYDRO TEST PRESSURE	2250 PSIG.
SOIL COVER MIN.	4 ft

LEGEND :

RIVER / CANAL / DITCH

SURFACED ROAD

UNSURFACED ROAD

TRACK / PLATFORM

BENCH MARK

WALL

FENCE

PIPELINE PROFILE

ELECTRIC LINE

CUTTING AREA

GROUND PROFILE

TREE (NON FRUIT)

MAJOR CONTOUR

MINOR CONTOUR

TOP OF HILL

TOE OF HILL

VALVE

WATER LINE

FILLING AREA

ABBREVIATIONS:

AT	RADIO ANTENNA	PL	PIPELINE MARKER
CTM	BOUNDARY MARKER	PY	ELECTRICITY PYLON
BP	CATHODIC MARKER	RM	RUNWAY MARKERS
EP	ELECTRICITY POLE	SG	SIGNAL
FL	FLARE	SH	SEISMIC SHOT HOLE
KM	KILOMETER MARKER	SN	SIGN POST
LP	LAMP POST	ST	SETTING OUT MARKER
LPM	LAND PARCEL MARKER	TP	TELEPHONE POLE
MS	MAST	WT	WATER STAND PIPE
NV	NAVIGATION BEACON		

NOTES :

- ALL DIMENSIONS ARE IN METER UNLESS OTHERWISE STATED.
- HORIZONTAL AND VERTICAL CURVATURE OF SUCH ELASTIC BENDS SHOULD IDEALLY NOT BE LESS THAN A RADIUS OF 500M. WHERE THIS CANNOT BE OBTAINED, THE CURVATURE OF THE CONSTRUCTED FLOWLINE SHALL NOT BE LESS THAN 200M, UNLESS COST-SET ARE USE.
- IF A LONGITUDINAL WELD IS PRESENT IN THE FLOWLINE PIPE, THE LONGITUDINAL WELD SHALL BE IN THE NEUTRAL ZONE, LOCATED AT AN ANGLE OF APPROXIMATELY 10 DEG TO THE CENTERLINE OF THE PIPE PERPENDICULAR TO THE PLANE OF BENDING, AND AWAY FROM THE CENTER POINT OF THE RADIUS.
- ALL DIMENSIONS, ELEVATIONS AND ORIENTATIONS TO BE VERIFIED BY THE CONTRACTOR BEFORE UNDERTAKING ANY KIND OF FABRICATION, CONSTRUCTION AND INSTALLATION WORK AT SITE.
- FOR RISERS DETAIL SEE DRAWING # 2664-DT-002 & 2664-DT-003.

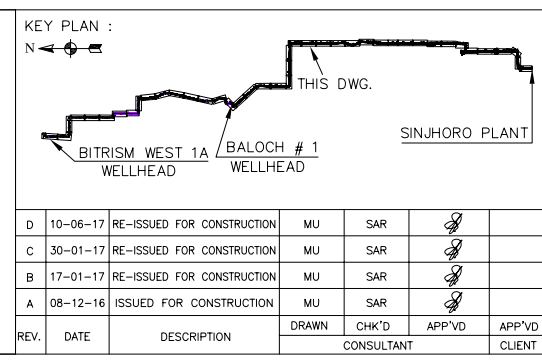

PC PETROCHEMICAL ENGINEERING CONSULTANTS
 C-2, BLOCK NO. 17, GULSHAN-E-IOBAL, NEAR NATIONAL STADIUM, KARACHI-75300, PAKISTAN.
 TEL: +92 (21) 34827780, 34961088, FAX: +92 21 34961089, E-Mail: contact@pec.com.pk web site: www.pec.com.pk

CLIENT OIL & GAS DEVELOPMENT COMPANY LTD.

PROJECT DEVELOPMENT OF BITRISM WEST 1A

TITLE PIPELINE ALIGNMENT DRAWING (18+000 TO 18+750)

DRAWING NO.	SCALE	SHEET
2664-PL-025	H. SCALE:1/2000 V. SCALE:1/1000	1 OF 1 A3

RE-ISSUED FOR CONSTRUCTION

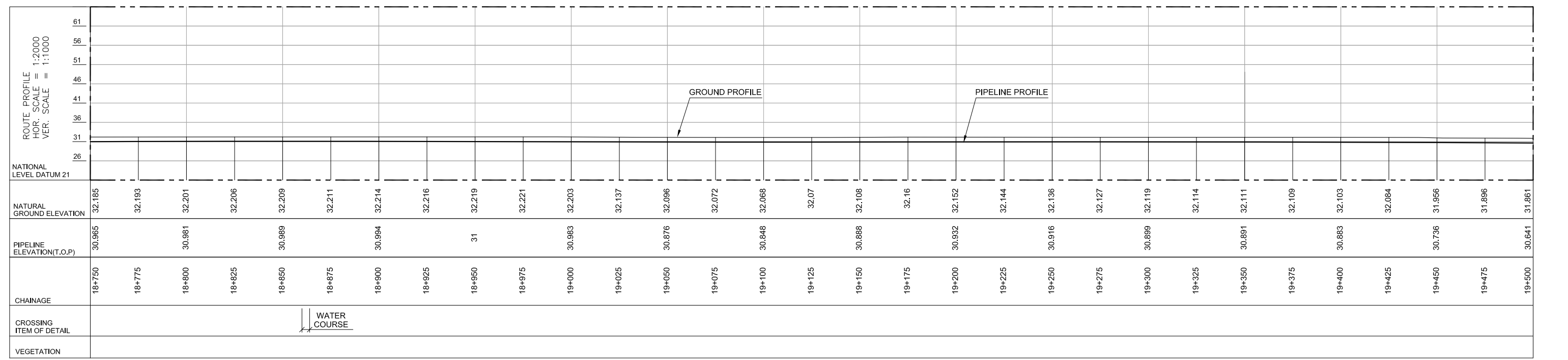
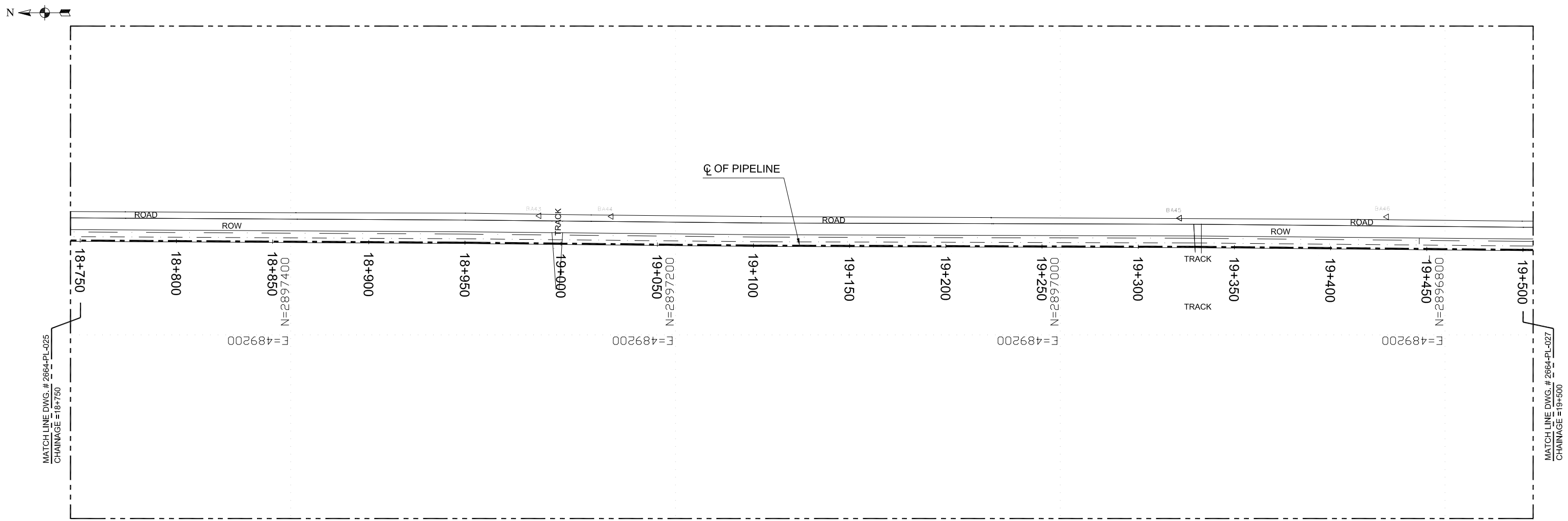

CONTROL:

SECONDARY SURVEY STATION (GPS)

TP TURNING POINT

LINE PIPE	8 INCH DIA, Sch. 80, CS, API 5L GR.X52.
LINE PIPE INSULATION	THREE LAYER POLYETHYLENE COATED
SPECIFICATION / CLASS	-
FLANGE RATING	CLASS 900# , RF
SERVICE LIMIT	-25 TO 150°F
HYDRO TEST PRESSURE	2250 PSIG.
SOIL COVER MIN.	4 ft

LEGEND :

RIVER / CANAL / DITCH	---
SURFACED ROAD	---
UNSURFACED ROAD	---
TRACK / PLATFORM	---
BENCH MARK	●
WALL	---
FENCE	---
PIPELINE PROFILE	---
ELECTRIC LINE	---
CUTTING AREA	---

GROUND PROFILE	---
TREE (NON FRUIT)	⊙
MAJOR CONTOUR	---
MINOR CONTOUR	---
TOP OF HILL	---
TOE OF HILL	---
VALVE	---
WATER LINE	---
FILLING AREA	---

ABBREVIATIONS:

AT	RADIO ANTENNA	PL	PIPELINE MARKER
CTM	BOUNDARY MARKER	PY	ELECTRICITY PYLON
BP	CATHODIC MARKER	RL	RUNWAY LIGHTS
EP	ELECTRICITY POLE	RM	RAILWAY MARKERS
FL	FLARE	SG	SIGNAL
KM	KILOMETER MARKER	SH	SEISMIC SHOT HOLE
LP	LAMP POST	SN	SIGN POST
LPM	LAND PARCEL MARKER	ST	SETTING OUT MARKER
MS	MAST	TP	TELEPHONE POLE
NV	NAVIGATION BEACON	WT	WATER STAND PIPE

NOTES :

- ALL DIMENSIONS ARE IN METER UNLESS OTHERWISE STATED.
- HORIZONTAL AND VERTICAL CURVATURE OF SUCH ELASTIC BENDS SHOULD IDEALLY NOT BE LESS THAN A RADIUS OF 500M. WHERE THIS CANNOT BE OBTAINED, THE CURVATURE OF THE CONSTRUCTED FLOWLINE SHALL NOT BE LESS THAN 200M, UNLESS OTHERWISE STATED.
- IF A LONGITUDINAL WELD IS PRESENT IN THE FLOWLINE PIPE, THE LONGITUDINAL WELD SHALL BE IN THE NEUTRAL ZONE, LOCATED AT AN ANGLE OF APPROXIMATELY 10 DEG TO THE CENTERLINE OF THE PIPE PERPENDICULAR TO THE PLANE OF BENDING, AND AWAY FROM THE CENTER POINT OF THE RADIUS.
- ALL DIMENSIONS, ELEVATIONS AND ORIENTATIONS TO BE VERIFIED BY THE CONTRACTOR BEFORE UNDERTAKING ANY KIND OF FABRICATION, CONSTRUCTION AND INSTALLATION WORK AT SITE.
- FOR RISERS DETAIL SEE DRAWING # 2664-DT-002 & 2664-DT-003.

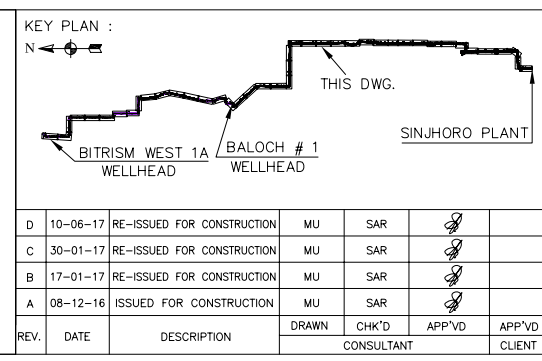

PC PETROCHEMICAL ENGINEERING CONSULTANTS
 C-2, BLOCK NO. 17, GULSHAN-E-IOBAL, NEAR NATIONAL STADIUM, KARACHI-75300, PAKISTAN.
 TEL: +92 (21) 34827780, 34961088, FAX: +92 21 34961089, E-Mail: contact@pec.com.pk web site: www.pec.com.pk

CLIENT: **OIL & GAS DEVELOPMENT COMPANY LTD.**

PROJECT: **DEVELOPMENT OF BITRISM WEST 1A**

TITLE: **PIPELINE ALIGNMENT DRAWING (18+750 TO 19+500)**

DRAWING NO. **2664-PL-026** SCALE: **1:2000** SHEET: **1 OF 1**

H. SCALE: 1/2000 V. SCALE: 1/1000 A3

RE-ISSUED FOR CONSTRUCTION

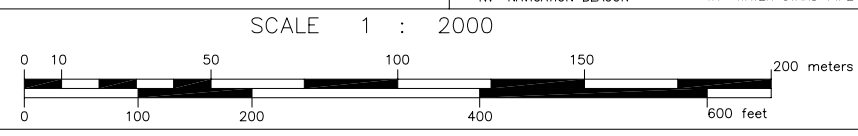

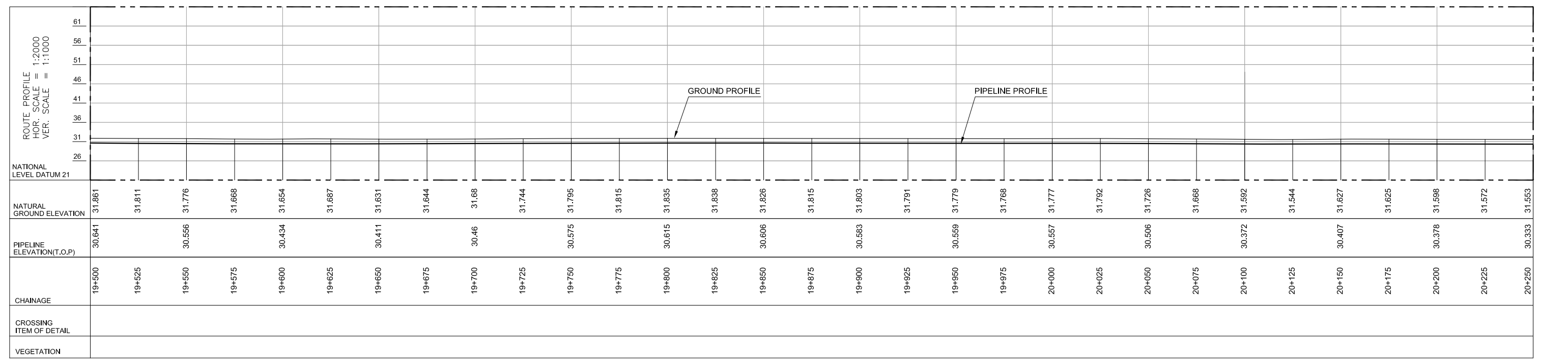
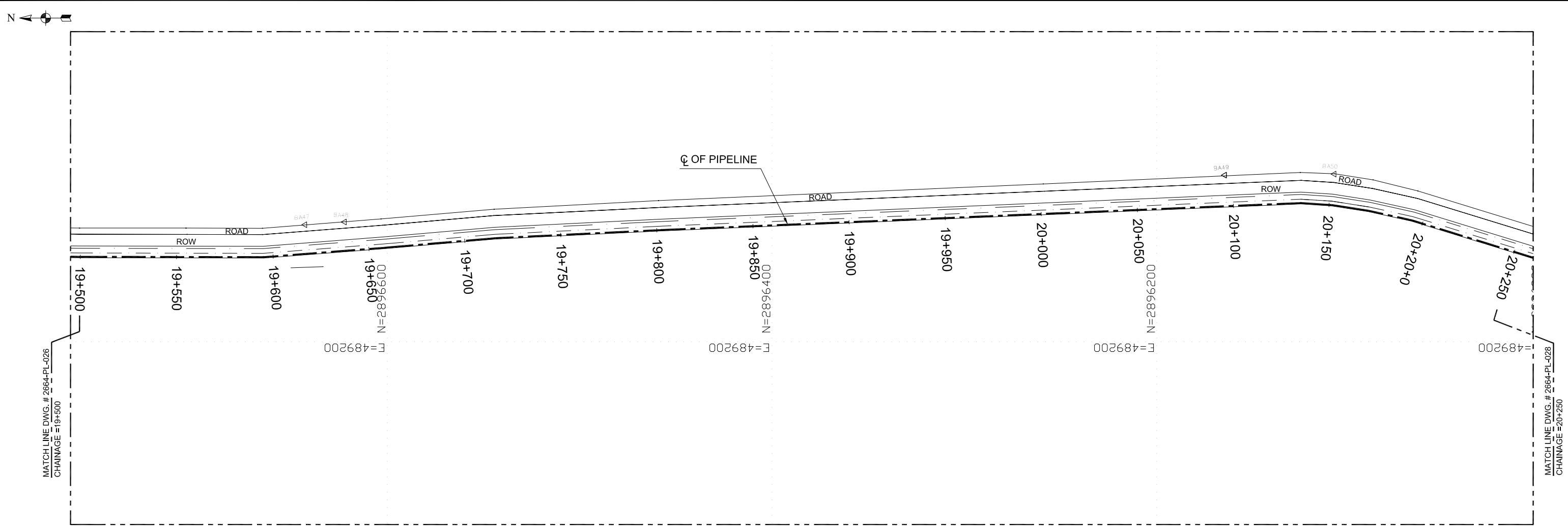

CONTROL:

SECONDARY SURVEY STATION (GPS)

TP TURNING POINT

LINE PIPE	8 INCH DIA, Sch. 80, CS, API 5L GR.X52.
LINE PIPE INSULATION	THREE LAYER POLYETHYLENE COATED
SPECIFICATION / CLASS	-
FLANGE RATING	CLASS 900# , RF
SERVICE LIMIT	-25 TO 150°F
HYDRO TEST PRESSURE	2250 PSIG.
SOIL COVER MIN.	4 ft

LEGEND :

RIVER / CANAL / DITCH	---
SURFACED ROAD	---
UNSURFACED ROAD	---
TRACK / PLATFORM	---
BENCH MARK	●
WALL	---
FENCE	---
PIPELINE PROFILE	---
ELECTRIC LINE	---
CUTTING AREA	▨

GROUND PROFILE

TREE (NON FRUIT)	⊙
MAJOR CONTOUR	~
MINOR CONTOUR	~
TOP OF HILL	▲
TOE OF HILL	▼
VALVE	⊠
WATER LINE	---
FILLING AREA	▨

ABBREVIATIONS:

AT	RADIO ANTENNA	PL	PIPELINE MARKER
CTM	BOUNDARY MARKER	PY	ELECTRICITY PYLON
BP	CATHODIC MARKER	RL	RUNWAY LIGHTS
EP	ELECTRICITY POLE	RM	RAILWAY MARKERS
FL	FLARE	SG	SIGNAL
KM	KILOMETER MARKER	SH	SEISMIC SHOT HOLE
LP	LAMP POST	SN	SIGN POST
LPM	LAND PARCEL MARKER	ST	SETTING OUT MARKER
MS	MAST	TP	TELEPHONE POLE
NV	NAVIGATION BEACON	WT	WATER STAND PIPE

NOTES :

- ALL DIMENSIONS ARE IN METER UNLESS OTHERWISE STATED.
- HORIZONTAL AND VERTICAL CURVATURE OF SUCH ELASTIC BENDS SHOULD IDEALLY NOT BE LESS THAN A RADIUS OF 500M. WHERE THIS CANNOT BE OBTAINED, THE CURVATURE OF THE CONSTRUCTED FLOWLINE SHALL NOT BE LESS THAN 200M, UNLESS COST-SET ARE USE.
- IF A LONGITUDINAL WELD IS PRESENT IN THE FLOWLINE PIPE, THE LONGITUDINAL WELD SHALL BE IN THE NEUTRAL ZONE, LOCATED AT AN ANGLE OF APPROXIMATELY 10 DEG TO THE CENTERLINE OF THE PIPE PERPENDICULAR TO THE PLANE OF BENDING, AND AWAY FROM THE CENTER POINT OF THE RADIUS.
- ALL DIMENSIONS, ELEVATIONS AND ORIENTATIONS TO BE VERIFIED BY THE CONTRACTOR BEFORE UNDERTAKING ANY KIND OF FABRICATION, CONSTRUCTION AND INSTALLATION WORK AT SITE.
- FOR RISERS DETAIL SEE DRAWING # 2664-DT-002 & 2664-DT-003.

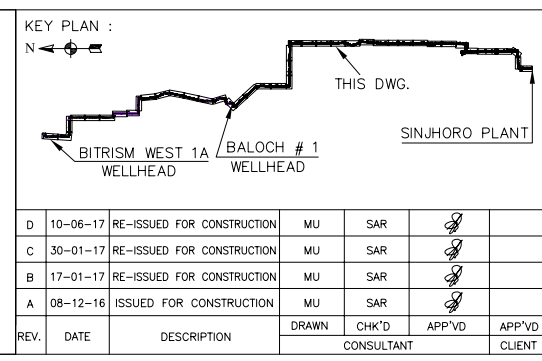

PC PETROCHEMICAL ENGINEERING CONSULTANTS
 C-2, BLOCK NO. 17, GULSHAN-E-IOBAL, NEAR NATIONAL STADIUM, KARACHI-75300, PAKISTAN.
 TEL: +92 (21) 34827780, 34961088, FAX: +92 21 34961089, E-Mail: contact@pec.com.pk web site: www.pec.com.pk

CLIENT
 OIL & GAS DEVELOPMENT COMPANY LTD.

PROJECT
 DEVELOPMENT OF BITRISM WEST 1A

TITLE
 PIPELINE ALIGNMENT DRAWING
 (19+500 TO 20+250)

DRAWING NO.	SCALE	SHEET
2664-PL-027	H. SCALE:1/2000 V. SCALE:1/1000	1 OF 1 A3

RE-ISSUED FOR CONSTRUCTION

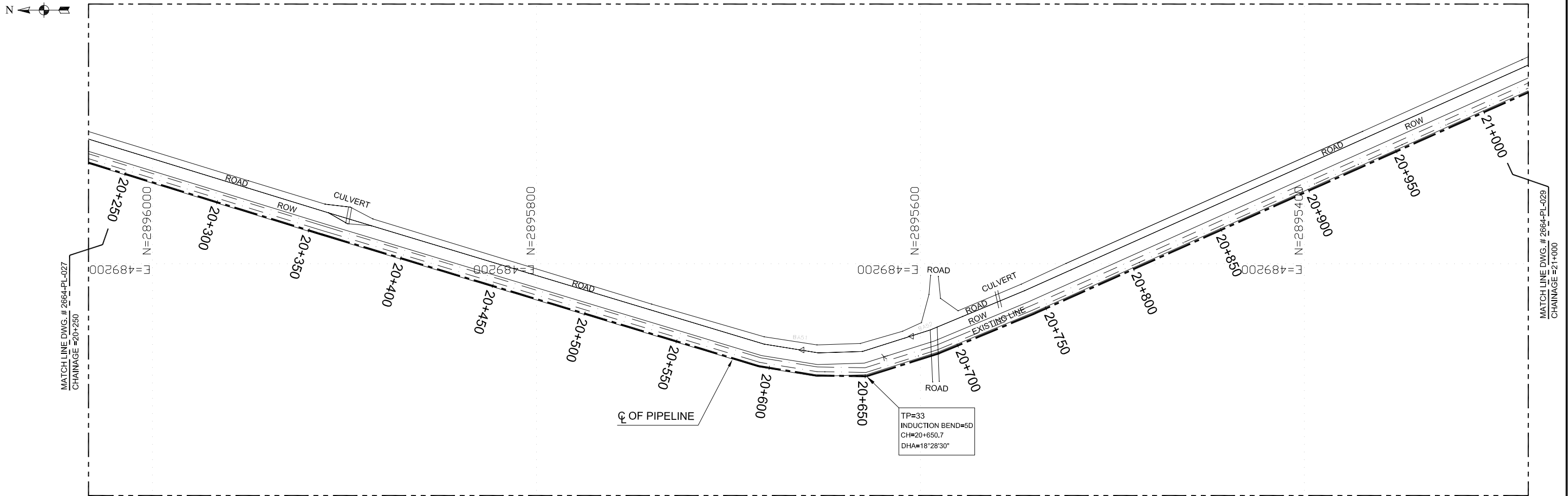

ROUTE PROFILE HOR. SCALE = 1:2000 VER. SCALE = 1:1000	61		56		51		46		41		36		31		26																		
	GROUND PROFILE		PIPELINE PROFILE																														
NATIONAL LEVEL DATUM 21	31.553	31.523	31.432	31.339	31.288	31.259	31.23	31.253	31.331	31.375	31.389	31.4	31.386	31.369	31.352	31.336	31.328	31.328	31.329	31.33	31.331	31.331	31.332	31.333	31.334	31.334	31.335	31.336	31.344	31.363	31.386	31.343	
NATURAL GROUND ELEVATION	30.333		30.212		30.088		30.01		30.111		30.169		30.166		30.132		30.108	30.108	30.11		30.111		30.113		30.114		30.116		30.143		30.123		
PIPELINE ELEVATION(T.O.P)	20+250	20+275	20+300	20+325	20+350	20+375	20+400	20+425	20+450	20+475	20+500	20+525	20+550	20+575	20+600	20+625	20+650	20+650.369	20+675	20+700	20+725	20+750	20+775	20+800	20+825	20+850	20+875	20+900	20+925	20+950	20+975	21+000	
CHAINAGE																																	
CROSSING ITEM OF DETAIL																																	
VEGETATION																																	

CONTROL:	
SECONDARY SURVEY STATION (GPS)	
TP TURNING POINT	
LINE PIPE	8 INCH DIA, Sch. 80, CS, API 5L GR.X52.
LINE PIPE INSULATION	THREE LAYER POLYETHYLENE COATED
SPECIFICATION / CLASS	-
FLANGE RATING	CLASS 900#, RF
SERVICE LIMIT	-25 TO 150°F
HYDRO TEST PRESSURE	2250 PSIG.
SOIL COVER MIN.	4 ft

LEGEND :	
RIVER / CANAL / DITCH	
SURFACED ROAD	
UNSURFACED ROAD	
TRACK / PLATFORM	
BENCH MARK	
WALL	
FENCE	
PIPELINE PROFILE	
ELECTRIC LINE	
CUTTING AREA	
GROUND PROFILE	
TREE (NON FRUIT)	
MAJOR CONTOUR	
MINOR CONTOUR	
TOP OF HILL	
TOE OF HILL	
VALVE	
WATER LINE	
FILLING AREA	

ABBREVIATIONS:	
AT RADIO ANTENNA	PL PIPELINE MARKER
CTM BOUNDARY MARKER	PY ELECTRICITY PYLON
BP CATHODIC MARKER	RL RUNWAY LIGHTS
EP ELECTRICITY POLE	RM RAILWAY MARKERS
FL FLARE	SG SIGNAL
KM KILOMETER MARKER	SH SEISMIC SHOT HOLE
LP LAMP POST	SN SIGN POST
LPM LAND PARCEL MARKER	ST SETTING OUT MARKER
MS MAST	TP TELEPHONE POLE
NV NAVIGATION BEACON	WT WATER STAND PIPE

NOTES :

- ALL DIMENSIONS ARE IN METER UNLESS OTHERWISE STATED.
- HORIZONTAL AND VERTICAL CURVATURE OF SUCH ELASTIC BENDS SHOULD IDEALLY NOT BE LESS THAN A RADIUS OF 500M. WHERE THIS CANNOT BE OBTAINED, THE CURVATURE OF THE CONSTRUCTED FLOWLINE SHALL NOT BE LESS THAN 200M, UNLESS COST-SET ARE USE.
- IF A LONGITUDINAL WELD IS PRESENT IN THE FLOWLINE PIPE, THE LONGITUDINAL WELD SHALL BE IN THE NEUTRAL ZONE, LOCATED AT AN ANGLE OF APPROXIMATELY 10 DEG TO THE CENTERLINE OF THE PIPE PERPENDICULAR TO THE PLANE OF BENDING, AND AWAY FROM THE CENTER POINT OF THE RADIUS.
- ALL DIMENSIONS, ELEVATIONS AND ORIENTATIONS TO BE VERIFIED BY THE CONTRACTOR BEFORE UNDERTAKING ANY KIND OF FABRICATION, CONSTRUCTION AND INSTALLATION WORK AT SITE.
- FOR RISERS DETAIL SEE DRAWING # 2664-DT-002 & 2664-DT-003.

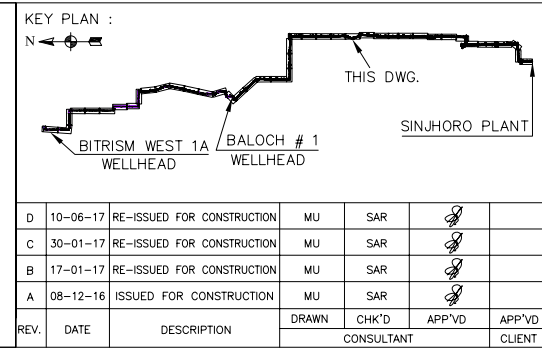

PC PETROCHEMICAL ENGINEERING CONSULTANTS
 C-2, BLOCK NO. 17, GULSHAN-E-IOBAL, NEAR NATIONAL STADIUM, KARACHI-75300, PAKISTAN.
 TEL: +92 (21) 34827780, 34961088, FAX: +92 21 34961089, E-Mail: contact@pec.com.pk web site: www.pec.com.pk

CLIENT: **OIL & GAS DEVELOPMENT COMPANY LTD.**

PROJECT: **DEVELOPMENT OF BITRISM WEST 1A**

TITLE: **PIPELINE ALIGNMENT DRAWING (20+250 TO 21+000)**

D	10-06-17	RE-ISSUED FOR CONSTRUCTION	MU	SAR		
C	30-01-17	RE-ISSUED FOR CONSTRUCTION	MU	SAR		
B	17-01-17	RE-ISSUED FOR CONSTRUCTION	MU	SAR		
A	08-12-16	ISSUED FOR CONSTRUCTION	MU	SAR		

REV.	DATE	DESCRIPTION	DRAWN	CHK'D	APP'VD	APP'VD
					CONSULTANT	CLIENT

DRAWING NO. **2664-PL-028** SCALE **1:2000** SHEET **1 OF 1**
 H. SCALE:1/2000 V. SCALE:1/1000 A3

RE-ISSUED FOR CONSTRUCTION

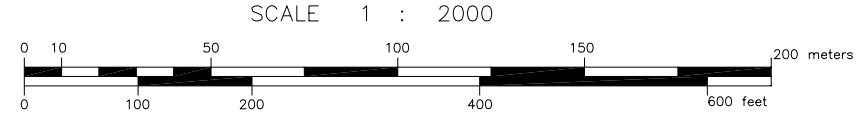

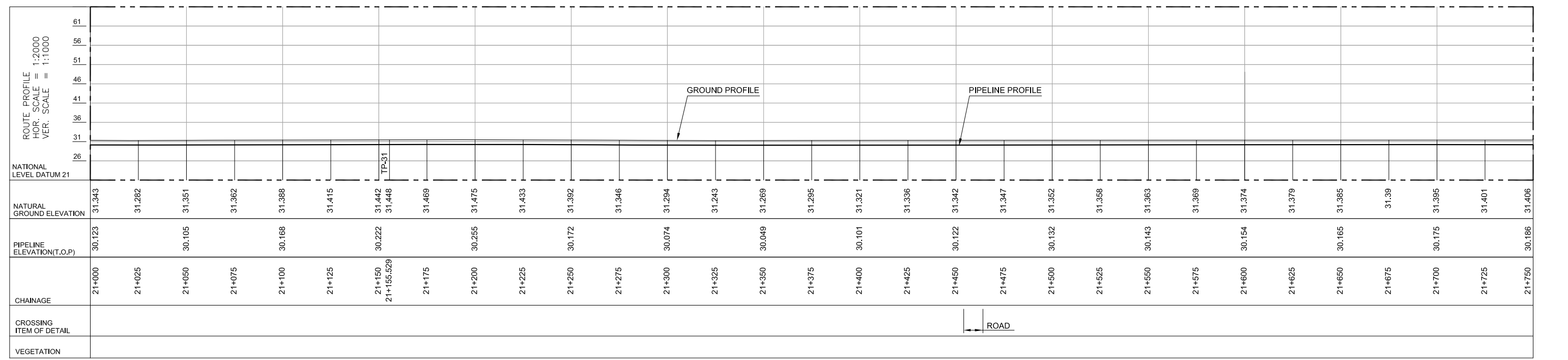
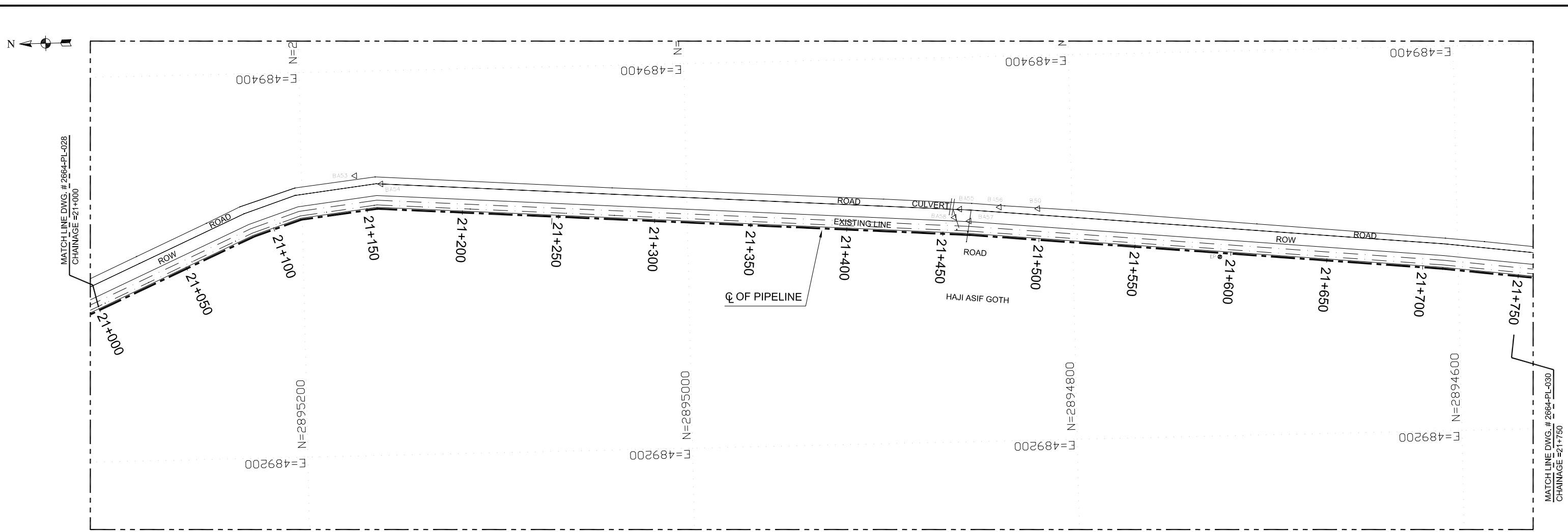

CONTROL:

SECONDARY SURVEY STATION (GPS)

TP TURNING POINT

LINE PIPE	8 INCH DIA, Sch. 80, CS, API 5L GR.X52
LINE PIPE INSULATION	THREE LAYER POLYETHYLENE COATED
SPECIFICATION / CLASS	-
FLANGE RATING	CLASS 900# , RF
SERVICE LIMIT	-25 TO 150°F
HYDRO TEST PRESSURE	2250 PSIG.
SOIL COVER MIN.	4 ft

LEGEND :

RIVER / CANAL / DITCH	---
SURFACED ROAD	---
UNSURFACED ROAD	---
TRACK / PLATFORM	---
BENCH MARK	●
WALL	---
FENCE	---
PIPELINE PROFILE	---
ELECTRIC LINE	---
CUTTING AREA	▨

GROUND PROFILE	---
TREE (NON FRUIT)	⊙
MAJOR CONTOUR	---
MINOR CONTOUR	---
TOP OF HILL	▲
TOE OF HILL	▽
VALVE	⊕
WATER LINE	---
FILLING AREA	▨

ABBREVIATIONS:

AT	RADIO ANTENNA	PL	PIPELINE MARKER
CTM	BOUNDARY MARKER	PY	ELECTRICITY PYLON
BP	CATHODIC MARKER	RL	RUNWAY LIGHTS
EP	ELECTRICITY POLE	RM	RAILWAY MARKERS
FL	FLARE	SG	SIGNAL
KM	KILOMETER MARKER	SH	SEISMIC SHOT HOLE
LP	LAMP POST	SN	SIGN POST
LPM	LAND PARCEL MARKER	ST	SETTING OUT MARKER
MS	MAST	TP	TELEPHONE POLE
NV	NAVIGATION BEACON	WT	WATER STAND PIPE

NOTES :

- ALL DIMENSIONS ARE IN METER UNLESS OTHERWISE STATED.
- HORIZONTAL AND VERTICAL CURVATURE OF SUCH ELASTIC BENDS SHOULD IDEALLY NOT BE LESS THAN A RADIUS OF 500M. WHERE THIS CANNOT BE OBTAINED, THE CURVATURE OF THE CONSTRUCTED FLOWLINE SHALL NOT BE LESS THAN 200M, UNLESS COST-SET ARE USE.
- IF A LONGITUDINAL WELD IS PRESENT IN THE FLOWLINE PIPE, THE LONGITUDINAL WELD SHALL BE IN THE NEUTRAL ZONE, LOCATED AT AN ANGLE OF APPROXIMATELY 10 DEG TO THE CENTERLINE OF THE PIPE PERPENDICULAR TO THE PLANE OF BENDING, AND AWAY FROM THE CENTER POINT OF THE RADIUS.
- ALL DIMENSIONS, ELEVATIONS AND ORIENTATIONS TO BE VERIFIED BY THE CONTRACTOR BEFORE UNDERTAKING ANY KIND OF FABRICATION, CONSTRUCTION AND INSTALLATION WORK AT SITE.
- FOR RISERS DETAIL SEE DRAWING # 2664-DT-002 & 2664-DT-003.

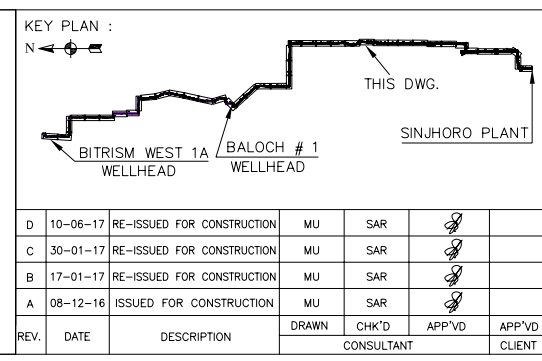

PC PETROCHEMICAL ENGINEERING CONSULTANTS
 C-2, BLOCK NO. 17, GULSHAN-E-IOBAL, NEAR NATIONAL STADIUM, KARACHI-75300, PAKISTAN.
 TEL: +92 (21) 34827780, 34961088, FAX: +92 21 34961089, E-Mail: contact@pec.com.pk web site: www.pec.com.pk

CLIENT OIL & GAS DEVELOPMENT COMPANY LTD.

PROJECT DEVELOPMENT OF BITRISM WEST 1A

TITLE PIPELINE ALIGNMENT DRAWING (21+000 TO 21+750)

DRAWING NO. 2664-PL-029

SCALE H. SCALE:1/2000
V. SCALE:1/1000

SHEET 1 OF 1
A3

RE-ISSUED FOR CONSTRUCTION

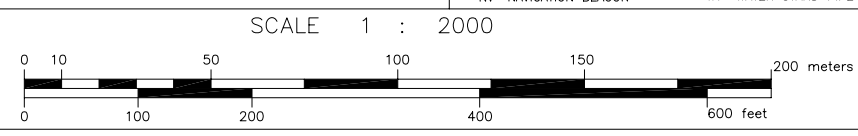

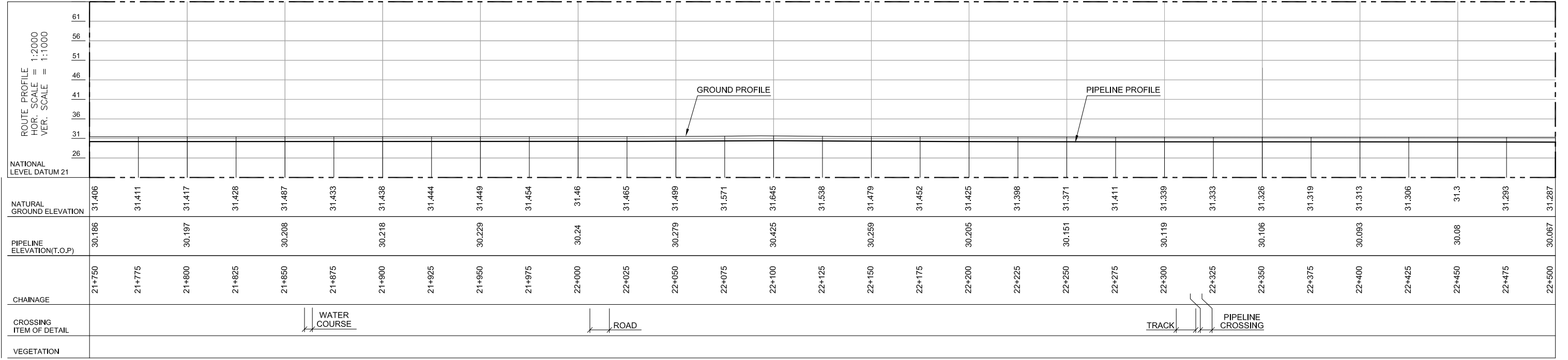
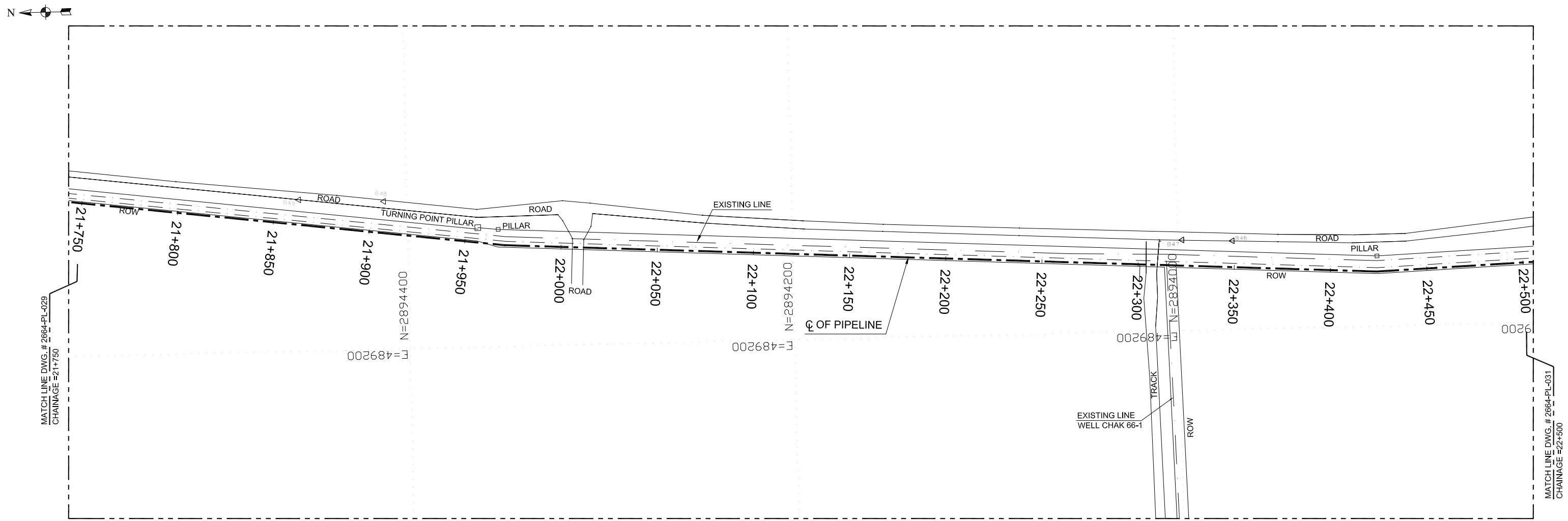

CONTROL:

SECONDARY SURVEY STATION (GPS)

TP TURNING POINT

LINE PIPE	8 INCH DIA, Sch. 80, CS, API 5L GR. X52.
LINE PIPE INSULATION	THREE LAYER POLYETHYLENE COATED
SPECIFICATION / CLASS	-
FLANGE RATING	CLASS 900# , RF
SERVICE LIMIT	-25 TO 150°F
HYDRO TEST PRESSURE	2250 PSIG.
SOIL COVER MIN.	4 ft

LEGEND :

RIVER / CANAL / DITCH	---
SURFACED ROAD	---
UNSURFACED ROAD	---
TRACK / PLATFORM	---
BANCH MARK	●
WALL	---
FENCE	---
PIPELINE PROFILE	---
ELECTRIC LINE	---
CUTTING AREA	---

GROUND PROFILE	---
TREE (NON FRUIT)	⊙
MAJOR CONTOUR	---
MINOR CONTOUR	---
TOP OF HILL	---
TOE OF HILL	---
VALVE	---
WATER LINE	---
FILLING AREA	---

ABBREVIATIONS:

AT	RADIO ANTENNA	PL	PIPELINE MARKER
CTM	BOUNDARY MARKER	PY	ELECTRICITY PYLON
BP	CATHODIC MARKER	RL	RUNWAY LIGHTS
EP	ELECTRICITY POLE	RM	RAILWAY MARKERS
FL	FLARE	SG	SIGNAL
KM	KILOMETER MARKER	SH	SEISMIC SHOT HOLE
LP	LAMP POST	SN	SIGN POST
LPM	LAND PARCEL MARKER	ST	SETTING OUT MARKER
MS	MAST	TP	TELEPHONE POLE
NV	NAVIGATION BEACON	WT	WATER STAND PIPE

NOTES :

- ALL DIMENSIONS ARE IN METER UNLESS OTHERWISE STATED.
- HORIZONTAL AND VERTICAL CURVATURE OF SUCH ELASTIC BENDS SHOULD IDEALLY NOT BE LESS THAN A RADIUS OF 500M. WHERE THIS CANNOT BE OBTAINED, THE CURVATURE OF THE CONSTRUCTED FLOWLINE SHALL NOT BE LESS THAN 200M, UNLESS COST-SET ARE USE.
- IF A LONGITUDINAL WELD IS PRESENT IN THE FLOWLINE PIPE, THE LONGITUDINAL WELD SHALL BE IN THE NEUTRAL ZONE, LOCATED AT AN ANGLE OF APPROXIMATELY 10 DEG TO THE CENTERLINE OF THE PIPE PERPENDICULAR TO THE PLANE OF BENDING, AND AWAY FROM THE CENTER POINT OF THE RADIUS.
- ALL DIMENSIONS, ELEVATIONS AND ORIENTATIONS TO BE VERIFIED BY THE CONTRACTOR BEFORE UNDERTAKING ANY KIND OF FABRICATION, CONSTRUCTION AND INSTALLATION WORK AT SITE.
- FOR RISERS DETAIL SEE DRAWING # 2664-DT-002 & 2664-DT-003.

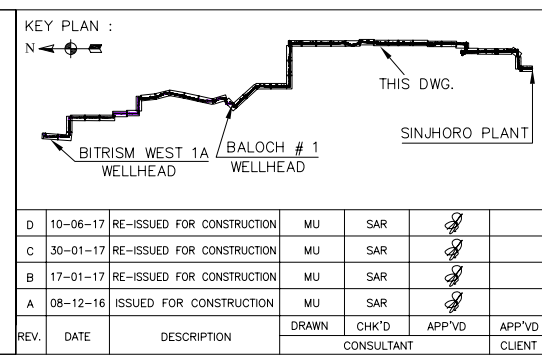

PC PETROCHEMICAL ENGINEERING CONSULTANTS
 C-2, BLOCK NO. 17, GULSHAN-E-IOBAL, NEAR NATIONAL STADIUM, KARACHI-75300, PAKISTAN.
 TEL: +92 (21) 34827780, 34961088, FAX: +92 21 34961089, E-Mail: contact@pec.com.pk web site: www.pec.com.pk

CLIENT
 OIL & GAS DEVELOPMENT COMPANY LTD.

PROJECT
 DEVELOPMENT OF BITRISM WEST 1A

TITLE
 PIPELINE ALIGNMENT DRAWING
 (21+750 TO 22+500)

DRAWING NO.
 2664-PL-030

SCALE
 H. SCALE: 1/2000
 V. SCALE: 1/1000

SHEET
 1 OF 1
 A3

RE-ISSUED FOR CONSTRUCTION

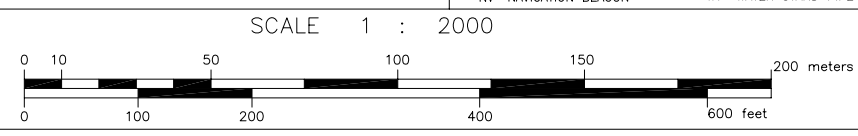

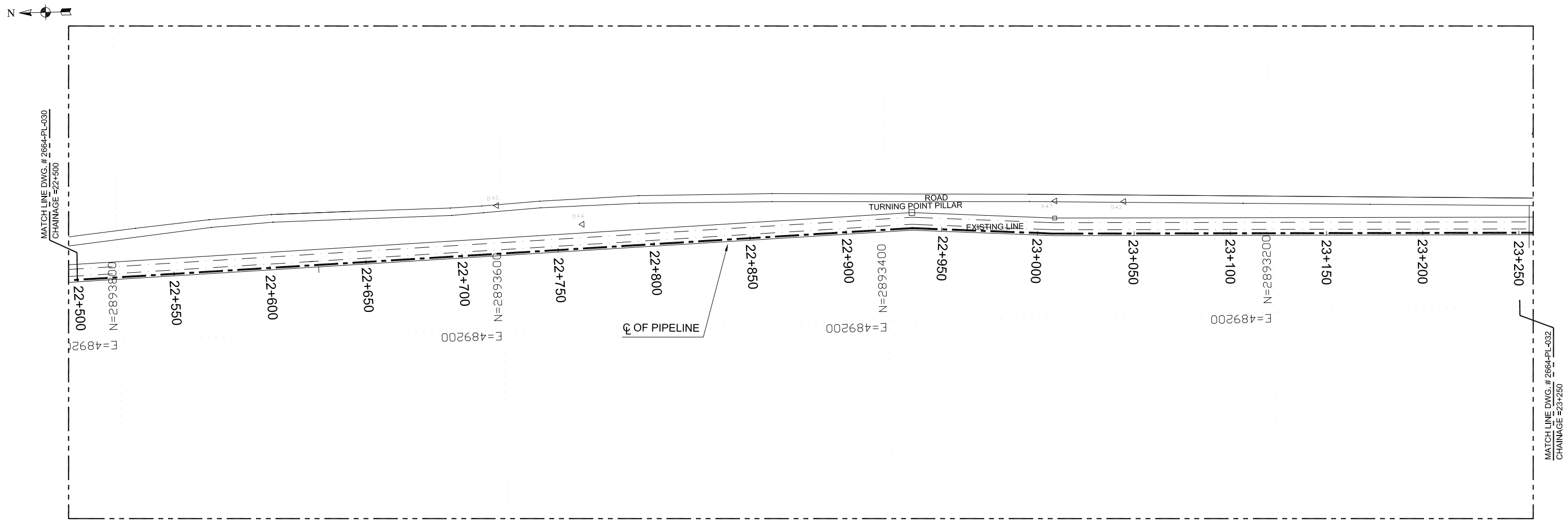

NATIONAL LEVEL DATUM 21	ROUTE PROFILE HOR. SCALE = 1:2000 VER. SCALE = 1:1000	
	GROUND PROFILE	PIPELINE PROFILE
NATURAL GROUND ELEVATION	31.287, 31.244, 31.232, 31.25, 31.258, 31.256, 31.255, 31.253, 31.252, 31.25, 31.249, 31.248, 31.246, 31.245, 31.243, 31.242, 31.238, 31.155, 31.122, 31.101, 31.092, 31.077, 31.062, 31.047, 31.032, 30.982, 30.938, 30.934, 30.929, 30.925, 30.921	30.067, 30.067, 30.038, 30.038, 30.038, 30.038, 30.032, 30.029, 30.026, 30.023, 30.018, 29.962, 29.872, 29.842, 29.812, 29.718, 29.709, 29.701
CHAINAGE	22+500, 22+525, 22+550, 22+575, 22+600, 22+625, 22+650, 22+675, 22+700, 22+725, 22+750, 22+775, 22+800, 22+825, 22+850, 22+875, 22+900, 22+925, 22+950, 22+975, 23+000, 23+025, 23+050, 23+075, 23+100, 23+125, 23+150, 23+175, 23+200, 23+225, 23+250	
CROSSING ITEM OF DETAIL		
VEGETATION		

CONTROL:

SECONDARY SURVEY STATION (GPS)

TP TURNING POINT

LINE PIPE	8 INCH DIA, Sch. 80, CS, API 5L GR.X52.
LINE PIPE INSULATION	THREE LAYER POLYETHYLENE COATED
SPECIFICATION / CLASS	-
FLANGE RATING	CLASS 900#, RF
SERVICE LIMIT	-25 TO 150°F
HYDRO TEST PRESSURE	2250 PSIG.
SOIL COVER MIN.	4 ft

LEGEND :

RIVER / CANAL / DITCH	---	GROUND PROFILE	—
SURFACED ROAD	—	TREE (NON FRUIT)	⊙
UNSURFACED ROAD	---	MAJOR CONTOUR	~
TRACK / PLATFORM	—	MINOR CONTOUR	~
BENCH MARK	⊙	TOP OF HILL	▲
WALL	—	TOE OF HILL	▽
FENCE	—	VALVE	⊕
PIPELINE PROFILE	—	WATER LINE	—
ELECTRIC LINE	—	FILLING AREA	▨
CUTTING AREA	▨		

ABBREVIATIONS:

AT	RADIO ANTENNA	PL	PIPELINE MARKER
CTM	BOUNDARY MARKER	PY	ELECTRICITY PYLON
BP	CATHODIC MARKER	RL	RUNWAY LIGHTS
EP	ELECTRICITY POLE	RM	RAILWAY MARKERS
FL	FLARE	SG	SIGNAL
KM	KILOMETER MARKER	SH	SEISMIC SHOT HOLE
LP	LAMP POST	SN	SIGN POST
LPM	LAND PARCEL MARKER	ST	SETTING OUT MARKER
MS	MAST	TP	TELEPHONE POLE
NV	NAVIGATION BEACON	WT	WATER STAND PIPE

NOTES :

- ALL DIMENSIONS ARE IN METER UNLESS OTHERWISE STATED.
- HORIZONTAL AND VERTICAL CURVATURE OF SUCH ELASTIC BENDS SHOULD IDEALLY NOT BE LESS THAN A RADIUS OF 500M. WHERE THIS CANNOT BE OBTAINED, THE CURVATURE OF THE CONSTRUCTED FLOWLINE SHALL NOT BE LESS THAN 200M, UNLESS COST-SET ARE USE.
- IF A LONGITUDINAL WELD IS PRESENT IN THE FLOWLINE PIPE, THE LONGITUDINAL WELD SHALL BE IN THE NEUTRAL ZONE, LOCATED AT AN ANGLE OF APPROXIMATELY 10 DEG TO THE CENTERLINE OF THE PIPE PERPENDICULAR TO THE PLANE OF BENDING, AND AWAY FROM THE CENTER POINT OF THE RADIUS.
- ALL DIMENSIONS, ELEVATIONS AND ORIENTATIONS TO BE VERIFIED BY THE CONTRACTOR BEFORE UNDERTAKING ANY KIND OF FABRICATION, CONSTRUCTION AND INSTALLATION WORK AT SITE.
- FOR RISERS DETAIL SEE DRAWING # 2664-DT-002 & 2664-DT-003.

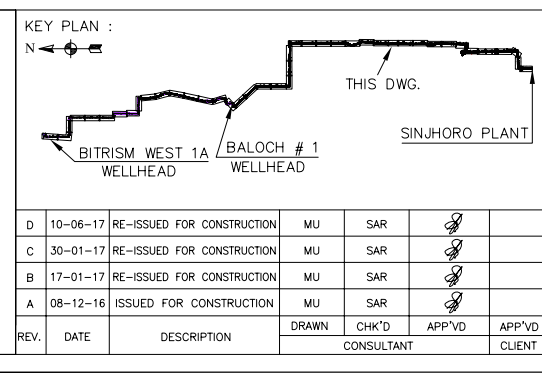

PC PETROCHEMICAL ENGINEERING CONSULTANTS
 C-2, BLOCK NO. 17, GULSHAN-E-IOQBAL, NEAR NATIONAL STADIUM, KARACHI-75300, PAKISTAN.
 TEL: +92 (21) 34827780, 34961088, FAX: +92 21 34961089, E-Mail: contact@pec.com.pk web site: www.pec.com.pk

CLIENT
 OIL & GAS DEVELOPMENT COMPANY LTD.

PROJECT
 DEVELOPMENT OF BITRISM WEST 1A

TITLE
 PIPELINE ALIGNMENT DRAWING
 (22+500 TO 23+250)

D	10-06-17	RE-ISSUED FOR CONSTRUCTION	MU	SAR		
C	30-01-17	RE-ISSUED FOR CONSTRUCTION	MU	SAR		
B	17-01-17	RE-ISSUED FOR CONSTRUCTION	MU	SAR		
A	08-12-16	ISSUED FOR CONSTRUCTION	MU	SAR		

REV.	DATE	DESCRIPTION	DRAWN	CHK'D	APP'VD	APP'VD
					CONSULTANT	CLIENT

DRAWING NO. 2664-PL-031

SCALE H. SCALE:1/2000 V. SCALE:1/1000

SHEET 1 OF 1 A3

RE-ISSUED FOR CONSTRUCTION

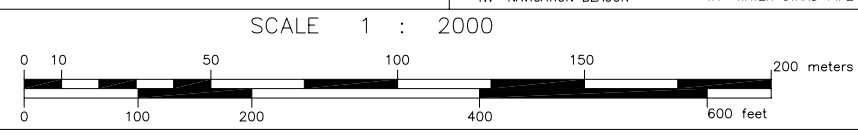

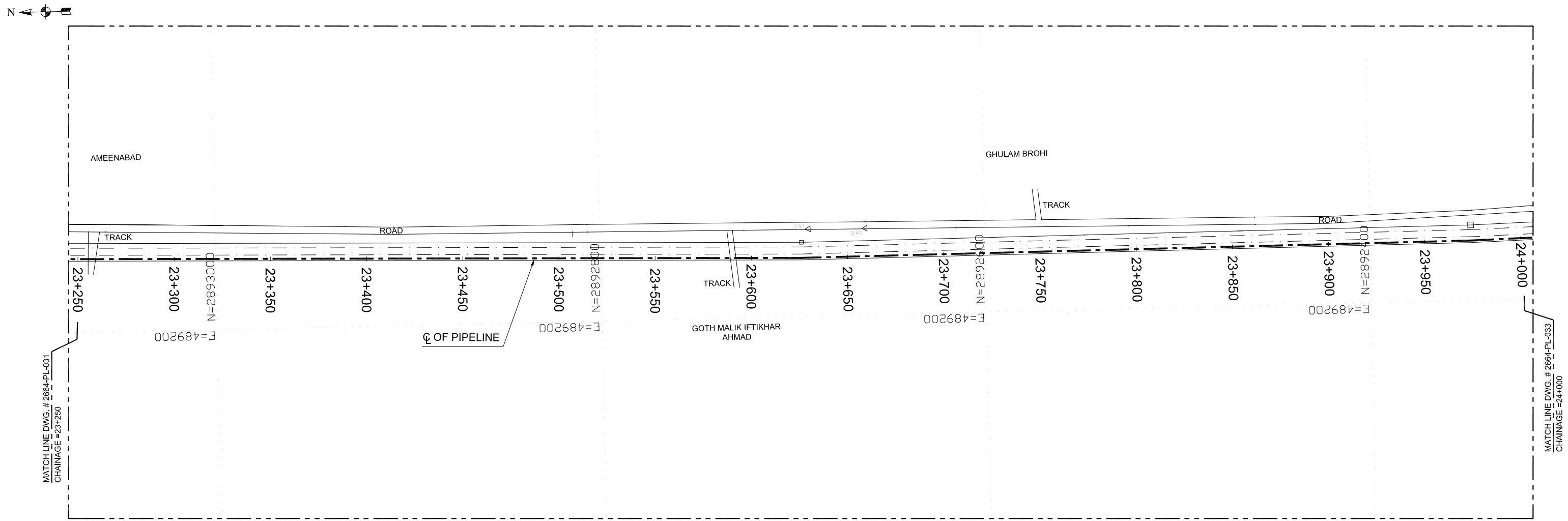

NATIONAL LEVEL DATUM 21	ROUTE PROFILE HOR. SCALE = 1:1000 VER. SCALE = 1:2000	
	GROUND PROFILE	PIPELINE PROFILE
NATURAL GROUND ELEVATION	30.921, 30.917, 30.912, 30.908, 30.903, 30.899, 30.895, 30.89, 30.889, 30.801, 30.75, 30.708, 30.697, 30.683, 30.654, 30.614, 30.564, 30.504, 30.470, 30.456, 30.44, 30.424, 30.408, 30.392, 30.368, 30.356, 30.372, 30.285, 30.285, 30.301, 30.379	29.701, 29.692, 29.693, 29.675, 29.639, 29.53, 29.472, 29.434, 29.344, 29.252, 29.22, 29.188, 29.148, 29.152, 29.029, 29.159
CHAINAGE	23+250, 23+275, 23+300, 23+325, 23+350, 23+375, 23+400, 23+425, 23+450, 23+475, 23+500, 23+525, 23+550, 23+575, 23+600, 23+625, 23+650, 23+675, 23+700, 23+725, 23+750, 23+775, 23+800, 23+825, 23+850, 23+875, 23+900, 23+925, 23+950, 23+975, 24+000	
CROSSING ITEM OF DETAIL	TRACK	TRACK
VEGETATION		

CONTROL:

SECONDARY SURVEY STATION (GPS)

TP TURNING POINT

LINE PIPE	8 INCH DIA, Sch. 80, CS, API 5L GR.X52.
LINE PIPE INSULATION	THREE LAYER POLYETHYLENE COATED
SPECIFICATION / CLASS	-
FLANGE RATING	CLASS 900# , RF
SERVICE LIMIT	-25 TO 150°F
HYDRO TEST PRESSURE	2250 PSIG.
SOIL COVER MIN.	4 ft

LEGEND :

RIVER / CANAL / DITCH	---	GROUND PROFILE	---
SURFACED ROAD	---	TREE (NON FRUIT)	⊙
UNSURFACED ROAD	---	MAJOR CONTOUR	~
TRACK / PLATFORM	---	MINOR CONTOUR	~
BENCH MARK	⊙	TOP OF HILL	▲
WALL	▬	TOE OF HILL	▽
FENCE	▬	VALVE	⊕
PIPELINE PROFILE	---	WATER LINE	---
ELECTRIC LINE	---	FILLING AREA	▨
CUTTING AREA	▨		

ABBREVIATIONS:

AT RADIO ANTENNA	PL PIPELINE MARKER
CTM BOUNDARY MARKER	PY ELECTRICITY PYLON
BP CATHODIC MARKER	RL RUNWAY LIGHTS
EP ELECTRICITY POLE	RM RAILWAY MARKERS
FL FLARE	SG SIGNAL
KM KILOMETER MARKER	SH SEISMIC SHOT HOLE
LP LAMP POST	SN SIGN POST
LPM LAND PARCEL MARKER	ST SETTING OUT MARKER
MS MAST	TP TELEPHONE POLE
NV NAVIGATION BEACON	WT WATER STAND PIPE

NOTES :

- ALL DIMENSIONS ARE IN METER UNLESS OTHERWISE STATED.
- HORIZONTAL AND VERTICAL CURVATURE OF SUCH ELASTIC BENDS SHOULD IDEALLY NOT BE LESS THAN A RADIUS OF 500M. WHERE THIS CANNOT BE OBTAINED, THE CURVATURE OF THE CONSTRUCTED FLOWLINE SHALL NOT BE LESS THAN 200M, UNLESS COST-SAVE ARE USE.
- IF A LONGITUDINAL WELD IS PRESENT IN THE FLOWLINE PIPE, THE LONGITUDINAL WELD SHALL BE IN THE NEUTRAL ZONE, LOCATED AT AN ANGLE OF APPROXIMATELY 10 DEG TO THE CENTERLINE OF THE PIPE PERPENDICULAR TO THE PLANE OF BENDING, AND AWAY FROM THE CENTER POINT OF THE RADIUS.
- ALL DIMENSIONS, ELEVATIONS AND ORIENTATIONS TO BE VERIFIED BY THE CONTRACTOR BEFORE UNDERTAKING ANY KIND OF FABRICATION, CONSTRUCTION AND INSTALLATION WORK AT SITE.
- FOR RISERS DETAIL SEE DRAWING # 2664-DT-002 & 2664-DT-003.

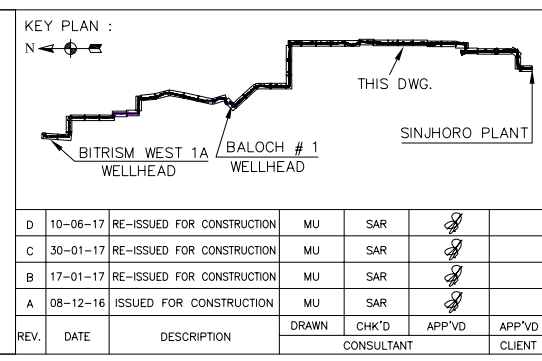

PC PETROCHEMICAL ENGINEERING CONSULTANTS
 C-2, BLOCK NO. 17, GULSHAN-E-IOBAL, NEAR NATIONAL STADIUM, KARACHI-75300, PAKISTAN.
 TEL: +92 (21) 34827780, 34961088, FAX: +92 21 34961089, E-Mail: contact@pec.com.pk web site: www.pec.com.pk

CLIENT: **OIL & GAS DEVELOPMENT COMPANY LTD.**

PROJECT: **DEVELOPMENT OF BITRISM WEST 1A**

TITLE: **PIPELINE ALIGNMENT DRAWING (23+250 TO 24+000)**

D	10-06-17	RE-ISSUED FOR CONSTRUCTION	MU	SAR		
C	30-01-17	RE-ISSUED FOR CONSTRUCTION	MU	SAR		
B	17-01-17	RE-ISSUED FOR CONSTRUCTION	MU	SAR		
A	08-12-16	ISSUED FOR CONSTRUCTION	MU	SAR		

REV.	DATE	DESCRIPTION	DRAWN	CHK'D	APP'VD	APP'VD
					CONSULTANT	CLIENT

DRAWING NO. **2664-PL-032**

SCALE: **H. SCALE:1/2000**
V. SCALE:1/1000

SHEET: **1 OF 1**
A3

RE-ISSUED FOR CONSTRUCTION

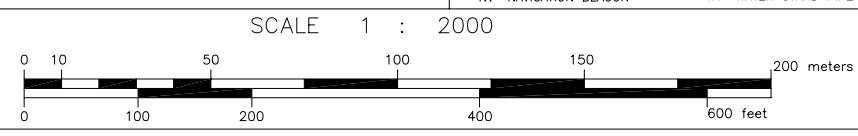

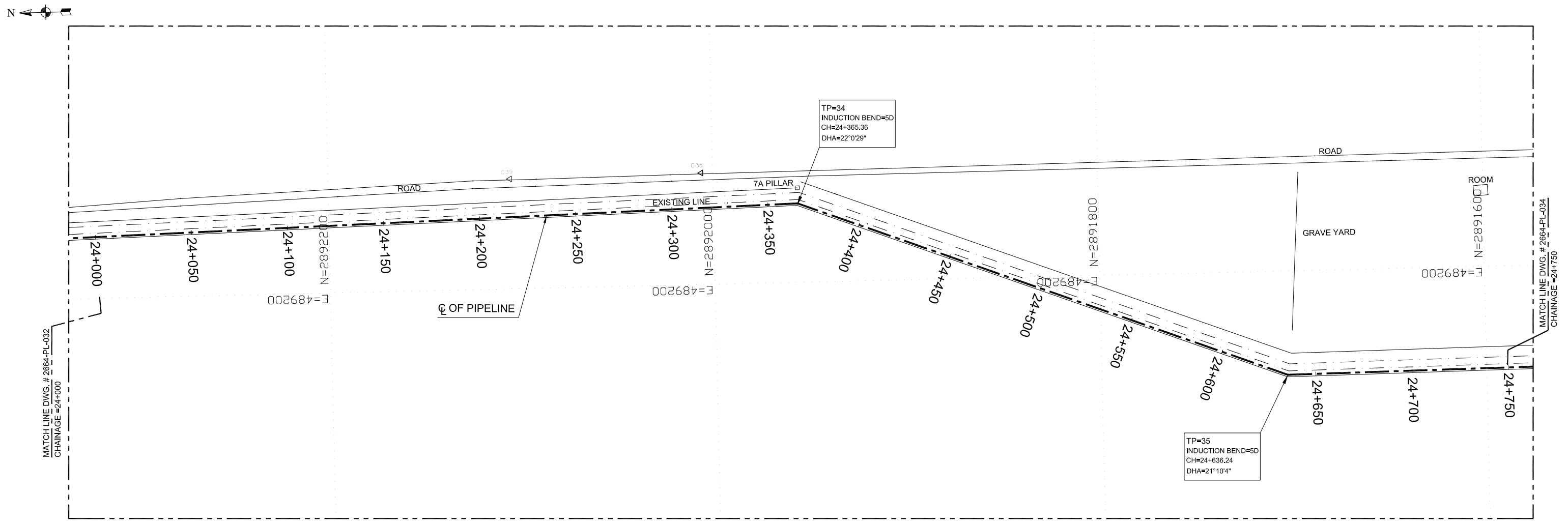

CHAINAGE	NATURAL GROUND ELEVATION	PIPELINE ELEVATION(T.O.P)
24+000	30.379	29.159
24+025	30.447	29.339
24+050	30.559	29.415
24+075	30.625	29.399
24+100	30.635	29.435
24+125	30.619	29.469
24+150	30.619	29.507
24+175	30.612	29.579
24+200	30.655	30.815
24+225	30.678	30.824
24+250	30.689	30.85
24+275	30.697	30.875
24+300	30.727	30.904
24+325	30.766	30.946
24+350	30.799	31.061
24+365.751	30.815	31.115
24+375	30.824	31.159
24+400	30.85	31.179
24+425	30.875	31.17
24+450	30.904	31.158
24+475	30.946	31.152
24+500	31.061	31.14
24+525	31.115	31.115
24+550	31.159	31.087
24+575	31.179	31.058
24+600	31.17	31.033
24+625	31.158	
24+635.862	31.152	
24+650	31.14	
24+675	31.115	
24+700	31.087	
24+725	31.058	
24+750	31.033	

CONTROL:	
SECONDARY SURVEY STATION (GPS)	
TP TURNING POINT	
LINE PIPE	8 INCH DIA, Sch. 80, CS, API 5L GR.X52
LINE PIPE INSULATION	THREE LAYER POLYETHYLENE COATED
SPECIFICATION / CLASS	-
FLANGE RATING	CLASS 900#, RF
SERVICE LIMIT	-25 TO 150°F
HYDRO TEST PRESSURE	2250 PSIG.
SOIL COVER MIN.	4 ft

LEGEND :	
RIVER / CANAL / DITCH	
SURFACED ROAD	
UNSURFACED ROAD	
TRACK / PLATFORM	
BENCH MARK	
WALL	
FENCE	
PIPELINE PROFILE	
ELECTRIC LINE	
CUTTING AREA	
GROUND PROFILE	
TREE (NON FRUIT)	
MAJOR CONTOUR	
MINOR CONTOUR	
TOP OF HILL	
TOE OF HILL	
VALVE	
WATER LINE	
FILLING AREA	

ABBREVIATIONS:	
AT RADIO ANTENNA	PL PIPELINE MARKER
CTM BOUNDARY MARKER	PY ELECTRICITY PYLON
BP CATHODIC MARKER	RL RUNWAY LIGHTS
EP ELECTRICITY POLE	RM RAILWAY MARKERS
FL FLARE	SG SIGNAL
KM KILOMETER MARKER	SH SEISMIC SHOT HOLE
LP LAMP POST	SN SIGN POST
LPM LAND PARCEL MARKER	ST SETTING OUT MARKER
MS MAST	TP TELEPHONE POLE
NV NAVIGATION BEACON	WT WATER STAND PIPE

NOTES :

- ALL DIMENSIONS ARE IN METER UNLESS OTHERWISE STATED.
- HORIZONTAL AND VERTICAL CURVATURE OF SUCH ELASTIC BENDS SHOULD IDEALLY NOT BE LESS THAN A RADIUS OF 500M. WHERE THIS CANNOT BE OBTAINED, THE CURVATURE OF THE CONSTRUCTED FLOWLINE SHALL NOT BE LESS THAN 200M, UNLESS COST-SET ARE USE.
- IF A LONGITUDINAL WELD IS PRESENT IN THE FLOWLINE PIPE, THE LONGITUDINAL WELD SHALL BE IN THE NEUTRAL ZONE, LOCATED AT AN ANGLE OF APPROXIMATELY 10 DEG TO THE CENTERLINE OF THE PIPE PERPENDICULAR TO THE PLANE OF BENDING, AND AWAY FROM THE CENTER POINT OF THE RADIUS.
- ALL DIMENSIONS, ELEVATIONS AND ORIENTATIONS TO BE VERIFIED BY THE CONTRACTOR BEFORE UNDERTAKING ANY KIND OF FABRICATION, CONSTRUCTION AND INSTALLATION WORK AT SITE.
- FOR RISERS DETAIL SEE DRAWING # 2664-DT-002 & 2664-DT-003.

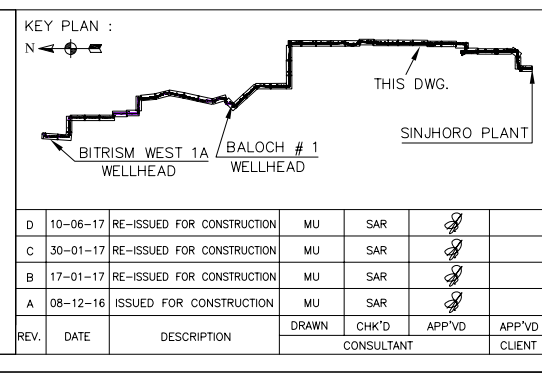

PC PETROCHEMICAL ENGINEERING CONSULTANTS
 C-2, BLOCK NO. 17, GULSHAN-E-IOBAL, NEAR NATIONAL STADIUM, KARACHI-75300, PAKISTAN.
 TEL: +92 (21) 34827780, 34961088, FAX: +92 21 34961089, E-Mail: contact@pec.com.pk web site: www.pec.com.pk

CLIENT: **OIL & GAS DEVELOPMENT COMPANY LTD.**

PROJECT: **DEVELOPMENT OF BITRISM WEST 1A**

TITLE: **PIPELINE ALIGNMENT DRAWING (24+000 TO 24+750)**

D	10-06-17	RE-ISSUED FOR CONSTRUCTION	MU	SAR		
C	30-01-17	RE-ISSUED FOR CONSTRUCTION	MU	SAR		
B	17-01-17	RE-ISSUED FOR CONSTRUCTION	MU	SAR		
A	08-12-16	ISSUED FOR CONSTRUCTION	MU	SAR		

REV.	DATE	DESCRIPTION	DRAWN	CHK'D	APP'VD	APP'VD
					CONSULTANT	CLIENT

DRAWING NO. **2664-PL-033** SCALE **1:2000** SHEET **1 OF 1**
 H. SCALE:1/2000 V. SCALE:1/1000 A3

RE-ISSUED FOR CONSTRUCTION

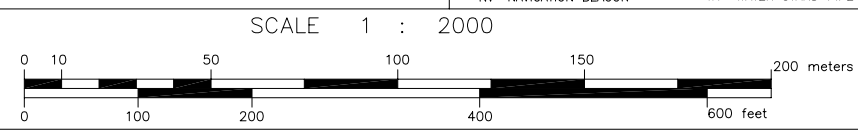

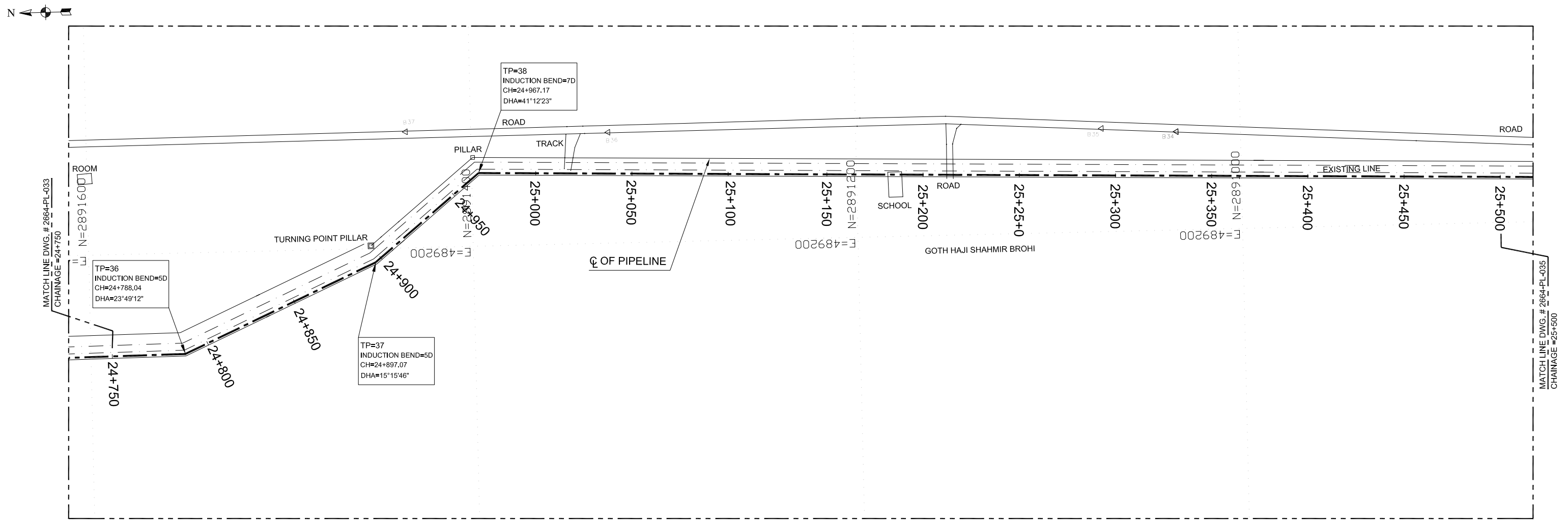

NATIONAL LEVEL DATUM 21	ROUTE PROFILE HOR. SCALE = 1:2000 VER. SCALE = 1:1000	
	GROUND PROFILE	PIPELINE PROFILE
61		
56		
51		
46		
41		
36		
31		
26		
	24+750	25+500
NATURAL GROUND ELEVATION	31.033	30.089
PIPELINE ELEVATION(T.O.P)	29.813	28.869
CHAINAGE	24+750	25+500
CROSSING ITEM OF DETAIL	WATER COURSE	ROAD
VEGETATION		

CONTROL:

SECONDARY SURVEY STATION (GPS)

TP TURNING POINT

LINE PIPE	8 INCH DIA, Sch. 80, CS, API 5L GR.X52.
LINE PIPE INSULATION	THREE LAYER POLYETHYLENE COATED
SPECIFICATION / CLASS	-
FLANGE RATING	CLASS 900# , RF
SERVICE LIMIT	-25 TO 150°F
HYDRO TEST PRESSURE	2250 PSIG.
SOIL COVER MIN.	4 ft

LEGEND :

RIVER / CANAL / DITCH	GROUND PROFILE
SURFACED ROAD	TREE (NON FRUIT)
UNSURFACED ROAD	MAJOR CONTOUR
TRACK / PLATFORM	MINOR CONTOUR
BENCH MARK	TOP OF HILL
WALL	TOE OF HILL
FENCE	VALVE
PIPELINE PROFILE	WATER LINE
ELECTRIC LINE	FILLING AREA
CUTTING AREA	

ABBREVIATIONS:

AT RADIO ANTENNA	PL PIPELINE MARKER
CTM BOUNDARY MARKER	PY ELECTRICITY PYLON
BP CATHODIC MARKER	RL RUNWAY LIGHTS
EP ELECTRICITY POLE	RM RAILWAY MARKERS
FL FLARE	SG SIGNAL
KM KILOMETER MARKER	SH SEISMIC SHOT HOLE
LP LAMP POST	SN SIGN POST
LPM LAND PARCEL MARKER	ST SETTING OUT MARKER
MS MAST	TP TELEPHONE POLE
NV NAVIGATION BEACON	WT WATER STAND PIPE

NOTES :

- ALL DIMENSIONS ARE IN METER UNLESS OTHERWISE STATED.
- HORIZONTAL AND VERTICAL CURVATURE OF SUCH ELASTIC BENDS SHOULD IDEALLY NOT BE LESS THAN A RADIUS OF 500M. WHERE THIS CANNOT BE OBTAINED, THE CURVATURE OF THE CONSTRUCTED FLOWLINE SHALL NOT BE LESS THAN 200M, UNLESS COST-SAVE ARE USE.
- IF A LONGITUDINAL WELD IS PRESENT IN THE FLOWLINE PIPE, THE LONGITUDINAL WELD SHALL BE IN THE NEUTRAL ZONE, LOCATED AT AN ANGLE OF APPROXIMATELY 10 DEG TO THE CENTERLINE OF THE PIPE PERPENDICULAR TO THE PLANE OF BENDING, AND AWAY FROM THE CENTER POINT OF THE RADIUS.
- ALL DIMENSIONS, ELEVATIONS AND ORIENTATIONS TO BE VERIFIED BY THE CONTRACTOR BEFORE UNDERTAKING ANY KIND OF FABRICATION, CONSTRUCTION AND INSTALLATION WORK AT SITE.
- FOR RISERS DETAIL SEE DRAWING # 2664-DT-002 & 2664-DT-003.

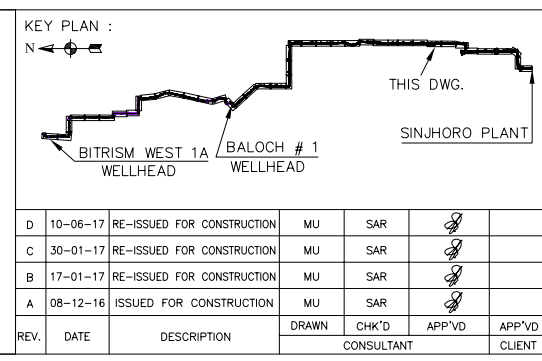

PC PETROCHEMICAL ENGINEERING CONSULTANTS
 C-2, BLOCK NO. 17, GULSHAN-E-IOBAL, NEAR NATIONAL STADIUM, KARACHI-75300, PAKISTAN.
 TEL: +92 (21) 34827780, 34961088, FAX: +92 21 34961089, E-Mail: contact@pec.com.pk web site: www.pec.com.pk

CLIENT: **OIL & GAS DEVELOPMENT COMPANY LTD.**

PROJECT: **DEVELOPMENT OF BITRISM WEST 1A**

TITLE: **PIPELINE ALIGNMENT DRAWING (24+750 TO 25+500)**

D	10-06-17	RE-ISSUED FOR CONSTRUCTION	MU	SAR		
C	30-01-17	RE-ISSUED FOR CONSTRUCTION	MU	SAR		
B	17-01-17	RE-ISSUED FOR CONSTRUCTION	MU	SAR		
A	08-12-16	ISSUED FOR CONSTRUCTION	MU	SAR		

REV.	DATE	DESCRIPTION	DRAWN	CHK'D	APP'VD	APP'VD
					CONSULTANT	CLIENT

DRAWING NO. **2664-PL-034** SCALE: **1:2000** SHEET: **1 OF 1**
 V. SCALE: **1:1000** A3

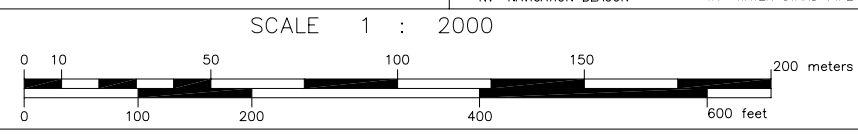

RE-ISSUED FOR CONSTRUCTION

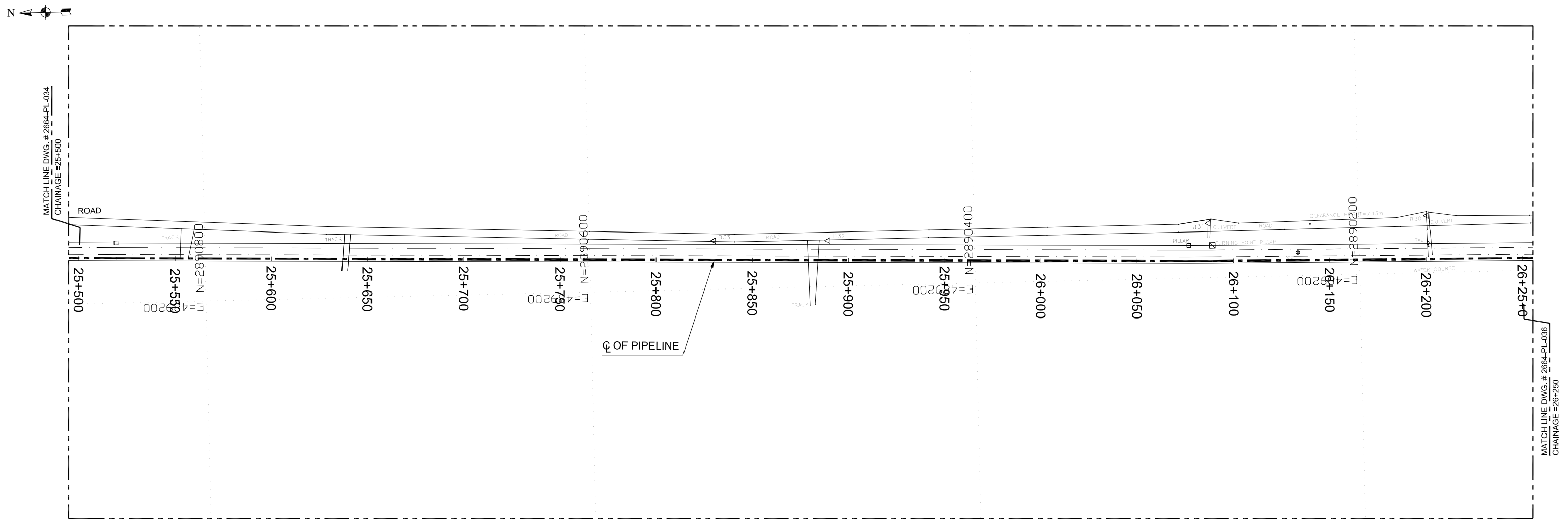

CHAINAGE	NATURAL GROUND ELEVATION	PIPELINE ELEVATION(T.O.P)
25+500	30.089	28.869
25+525	30.025	
25+550	29.961	28.741
25+575	29.918	
25+600	29.863	28.643
25+625	29.79	
25+650	29.677	28.457
25+675	29.594	
25+700	29.539	28.319
25+725	29.519	
25+750	29.5	28.28
25+775	29.48	
25+800	29.456	28.236
25+825	29.418	
25+850	29.432	28.212
25+875	29.497	
25+900	29.56	28.34
25+925	29.55	
25+950	29.553	28.333
25+975	29.564	
26+000	29.575	28.355
26+025	29.586	
26+050	29.597	28.377
26+075	29.608	
26+100	29.619	28.399
26+125	29.63	
26+150	29.642	28.422
26+175	29.653	
26+200	29.673	28.453
26+225	29.72	
26+250	29.778	28.568

CONTROL:

SECONDARY SURVEY STATION (GPS)

TP TURNING POINT

LINE PIPE	8 INCH DIA, Sch. 80, CS, API 5L GR.X52.
LINE PIPE INSULATION	THREE LAYER POLYETHYLENE COATED
SPECIFICATION / CLASS	-
FLANGE RATING	CLASS 900# , RF
SERVICE LIMIT	-25 TO 150°F
HYDRO TEST PRESSURE	2250 PSIG.
SOIL COVER MIN.	4 ft

LEGEND :

RIVER / CANAL / DITCH	---
SURFACED ROAD	---
UNSURFACED ROAD	---
TRACK / PLATFORM	---
BENCH MARK	●
WALL	---
FENCE	---
PIPELINE PROFILE	---
ELECTRIC LINE	---
CUTTING AREA	▨

GROUND PROFILE	---
TREE (NON FRUIT)	⊙
MAJOR CONTOUR	---
MINOR CONTOUR	---
TOP OF HILL	▲
TOE OF HILL	▼
VALVE	⊕
WATER LINE	---
FILLING AREA	▨

ABBREVIATIONS:

AT	RADIO ANTENNA	PL	PIPELINE MARKER
CTM	BOUNDARY MARKER	PY	ELECTRICITY PYLON
BP	CATHODIC MARKER	RL	RUNWAY LIGHTS
EP	ELECTRICITY POLE	RM	RAILWAY MARKERS
FL	FLARE	SG	SIGNAL
KM	KILOMETER MARKER	SH	SEISMIC SHOT HOLE
LP	LAMP POST	SN	SIGN POST
LPM	LAND PARCEL MARKER	ST	SETTING OUT MARKER
MS	MAST	TP	TELEPHONE POLE
NV	NAVIGATION BEACON	WT	WATER STAND PIPE

NOTES :

- ALL DIMENSIONS ARE IN METER UNLESS OTHERWISE STATED.
- HORIZONTAL AND VERTICAL CURVATURE OF SUCH ELASTIC BENDS SHOULD IDEALLY NOT BE LESS THAN A RADIUS OF 500M, WHERE THIS CANNOT BE OBTAINED, THE CURVATURE OF THE CONSTRUCTED FLOWLINE SHALL NOT BE LESS THAN 200M, UNLESS COST-SET ARE USE.
- IF A LONGITUDINAL WELD IS PRESENT IN THE FLOWLINE PIPE, THE LONGITUDINAL WELD SHALL BE IN THE NEUTRAL ZONE, LOCATED AT AN ANGLE OF APPROXIMATELY 10 DEG TO THE CENTERLINE OF THE PIPE PERPENDICULAR TO THE PLANE OF BENDING, AND AWAY FROM THE CENTER POINT OF THE RADIUS.
- ALL DIMENSIONS, ELEVATIONS AND ORIENTATIONS TO BE VERIFIED BY THE CONTRACTOR BEFORE UNDERTAKING ANY KIND OF FABRICATION, CONSTRUCTION AND INSTALLATION WORK AT SITE.
- FOR RISERS DETAIL SEE DRAWING # 2664-DT-002 & 2664-DT-003.

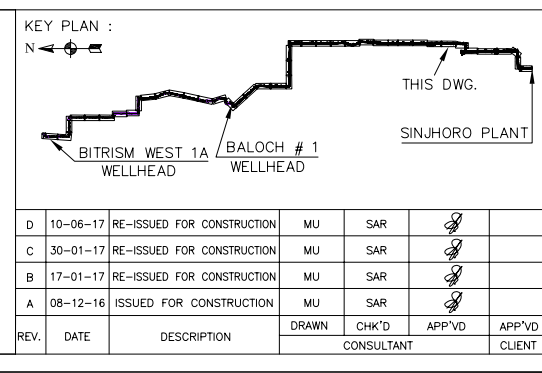

PC PETROCHEMICAL ENGINEERING CONSULTANTS
 C-2, BLOCK NO. 17, GULSHAN-E-IOBAL, NEAR NATIONAL STADIUM, KARACHI-75300, PAKISTAN.
 TEL: +92 (21) 34827780, 34961088, FAX: +92 21 34961089, E-Mail: contact@pec.com.pk web site: www.pec.com.pk

CLIENT: **OIL & GAS DEVELOPMENT COMPANY LTD.**

PROJECT: **DEVELOPMENT OF BITRISM WEST 1A**

TITLE: **PIPELINE ALIGNMENT DRAWING (25+500 TO 26+250)**

D	10-06-17	RE-ISSUED FOR CONSTRUCTION	MU	SAR	
C	30-01-17	RE-ISSUED FOR CONSTRUCTION	MU	SAR	
B	17-01-17	RE-ISSUED FOR CONSTRUCTION	MU	SAR	
A	08-12-16	ISSUED FOR CONSTRUCTION	MU	SAR	

REV.	DATE	DESCRIPTION	DRAWN	CHK'D	APP'VD	APP'VD
					CONSULTANT	CLIENT

DRAWING NO. **2664-PL-035** SCALE: **1:2000** SHEET: **1 OF 1**

V. SCALE: **1:1000** A3

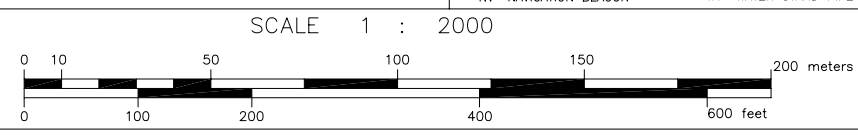

RE-ISSUED FOR CONSTRUCTION

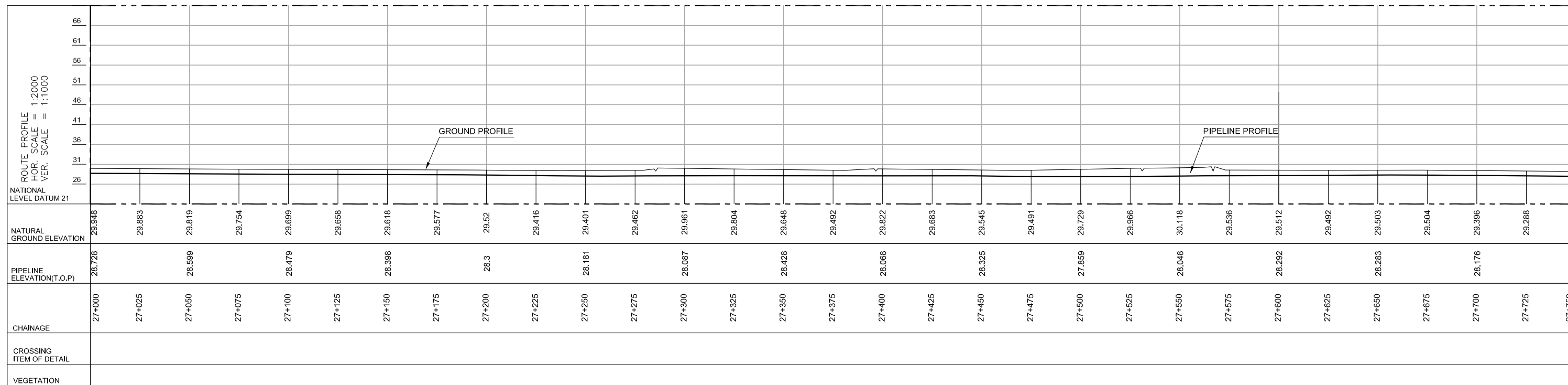
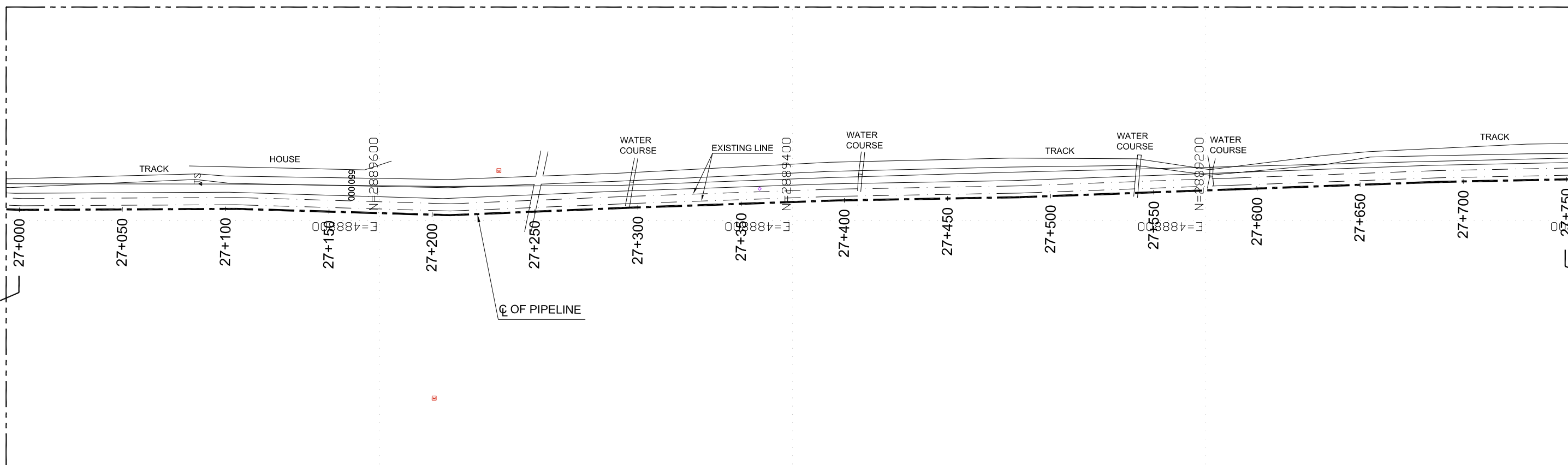

CONTROL:

SECONDARY SURVEY STATION (GPS)

TP TURNING POINT

LINE PIPE	8 INCH DIA, Sch. 80, CS, API 5L GR.XS2.
LINE PIPE INSULATION	THREE LAYER POLYETHYLENE COATED
SPECIFICATION / CLASS	-
FLANGE RATING	CLASS 900# , RF
SERVICE LIMIT	-25 TO 150°F
HYDRO TEST PRESSURE	2250 PSIG.
SOIL COVER MIN.	4 ft

LEGEND :

RIVER / CANAL / DITCH	---
SURFACED ROAD	---
UNSURFACED ROAD	---
TRACK / PLATFORM	---
BANCH MARK	○
WALL	▬
FENCE	▬
PIPELINE PROFILE	---
ELECTRIC LINE	---
CUTTING AREA	▨

GROUND PROFILE	---
TREE (NON FRUIT)	⊙
MAJOR CONTOUR	⊖
MINOR CONTOUR	⊖
TOP OF HILL	⊖
TOE OF HILL	⊖
VALVE	⊕
WATER LINE	---
FILLING AREA	▨

ABBREVIATIONS:

AT	RADIO ANTENNA	PL	PIPELINE MARKER
CTM	BOUNDARY MARKER	PY	ELECTRICITY PYLON
BP	CATHODIC MARKER	RL	RUNWAY LIGHTS
EP	ELECTRICITY POLE	RM	RAILWAY MARKERS
FL	FLARE	SG	SIGNAL
KM	KILOMETER MARKER	SH	SEISMIC SHOT HOLE
LP	LAMP POST	SN	SIGN POST
LPM	LAND PARCEL MARKER	ST	SETTING OUT MARKER
MS	MAST	TP	TELEPHONE POLE
NV	NAVIGATION BEACON	WT	WATER STAND PIPE

NOTES :

- ALL DIMENSIONS ARE IN METER UNLESS OTHERWISE STATED.
- HORIZONTAL AND VERTICAL CURVATURE OF SUCH ELASTIC BENDS SHOULD IDEALLY NOT BE LESS THAN A RADIUS OF 500M. WHERE THIS CANNOT BE OBTAINED, THE CURVATURE OF THE CONSTRUCTED FLOWLINE SHALL NOT BE LESS THAN 200M, UNLESS COST-SET ARE USE.
- IF A LONGITUDINAL WELD IS PRESENT IN THE FLOWLINE PIPE, THE LONGITUDINAL WELD SHALL BE IN THE NEUTRAL ZONE, LOCATED AT AN ANGLE OF APPROXIMATELY 10 DEG TO THE CENTERLINE OF THE PIPE PERPENDICULAR TO THE PLANE OF BENDING, AND AWAY FROM THE CENTER POINT OF THE RADIUS.
- ALL DIMENSIONS, ELEVATIONS AND ORIENTATIONS TO BE VERIFIED BY THE CONTRACTOR BEFORE UNDERTAKING ANY KIND OF FABRICATION, CONSTRUCTION AND INSTALLATION WORK AT SITE.
- FOR RISERS DETAIL SEE DRAWING # 2664-DT-002 & 2664-DT-003.

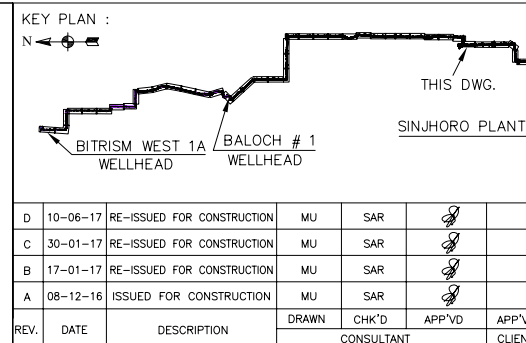

PC PETROCHEMICAL ENGINEERING CONSULTANTS
 C-2, BLOCK NO. 17, GULSHAN-E-IGBAL, NEAR NATIONAL STADIUM, KARACHI-75300, PAKISTAN.
 TEL: +92 (21) 34827780, 34961088. FAX: +92 21 34961089. E-Mail: contact@pec.com.pk web site: www.pec.com.pk

CLIENT: **OIL & GAS DEVELOPMENT COMPANY LTD.**

PROJECT: **DEVELOPMENT OF BITRISM WEST 1A**

TITLE: **PIPELINE ALIGNMENT DRAWING (27+000 TO 27+750)**

DRAWING NO. **2664-PL-037** SCALE: **1:2000** SHEET: **1 OF 1**

V. SCALE: **1:1000**

RE-ISSUED FOR CONSTRUCTION

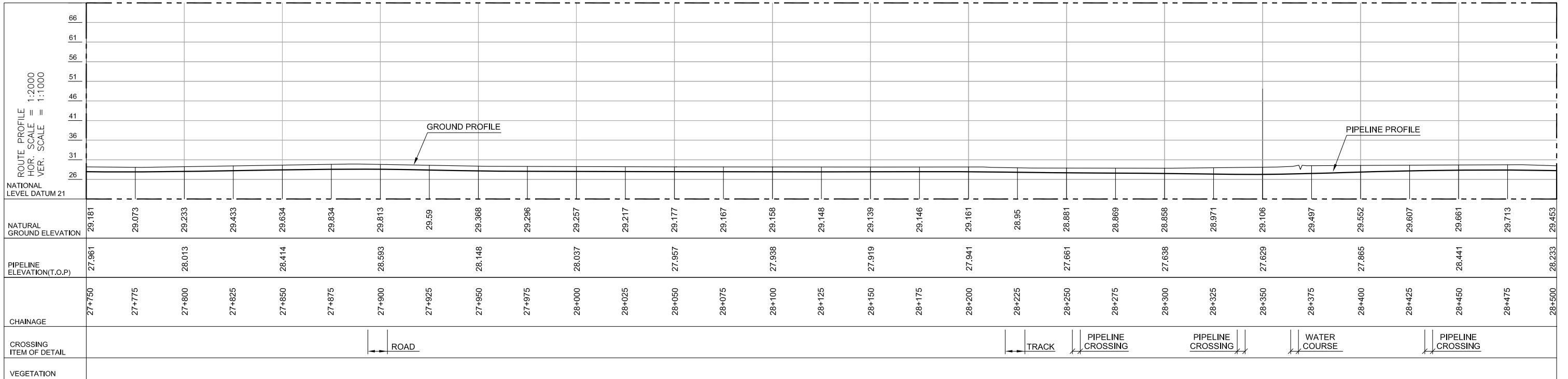
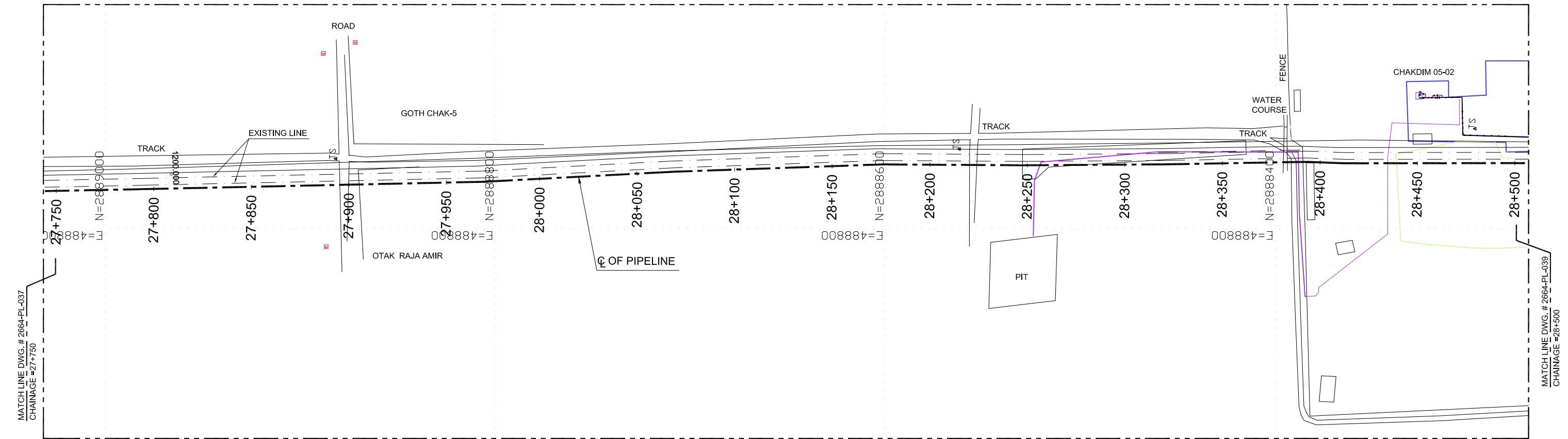
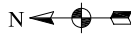

CONTROL:

SECONDARY SURVEY STATION (GPS)

TP TURNING POINT

LINE PIPE	8 INCH DIA, Sch. 80, CS, API 5L GR.X52.
LINE PIPE INSULATION	THREE LAYER POLYETHYLENE COATED
SPECIFICATION / CLASS	-
FLANGE RATING	CLASS 900# , RF
SERVICE LIMIT	-25 TO 150°F
HYDRO TEST PRESSURE	2250 PSIG.
SOIL COVER MIN.	4 ft

LEGEND :

RIVER / CANAL / DITCH	---
SURFACED ROAD	---
UNSURFACED ROAD	---
TRACK / PLATFORM	---
BANCH MARK	○
WALL	▨
FENCE	---
PIPELINE PROFILE	---
ELECTRIC LINE	---
CUTTING AREA	▨

GROUND PROFILE	---
TREE (NON FRUIT)	⊙
MAJOR CONTOUR	---
MINOR CONTOUR	---
TOP OF HILL	⌒
TOE OF HILL	⌒
VALVE	⊕
WATER LINE	---
FILLING AREA	▨

ABBREVIATIONS:

AT	RADIO ANTENNA	PL	PIPELINE MARKER
CTM	BOUNDARY MARKER	PY	ELECTRICITY PYLON
BP	CATHODIC MARKER	RL	RUNWAY LIGHTS
EP	ELECTRICITY POLE	RM	RAILWAY MARKERS
FL	FLARE	SC	SIGNAL
KM	KILOMETER MARKER	SH	SEISMIC SHOT HOLE
LP	LAMP POST	SN	SIGN POST
LPM	LAND PARCEL MARKER	ST	SETTING OUT MARKER
MS	MAST	TP	TELEPHONE POLE
NV	NAVIGATION BEACON	WT	WATER STAND PIPE

NOTES :

- ALL DIMENSIONS ARE IN METER UNLESS OTHERWISE STATED.
- HORIZONTAL AND VERTICAL CURVATURE OF SUCH ELASTIC BENDS SHOULD IDEALLY NOT BE LESS THAN A RADIUS OF 500M. WHERE THIS CANNOT BE OBTAINED, THE CURVATURE OF THE CONSTRUCTED FLOWLINE SHALL NOT BE LESS THAN 200M, UNLESS COST-SET ARE USE.
- IF A LONGITUDINAL WELD IS PRESENT IN THE FLOWLINE PIPE, THE LONGITUDINAL WELD SHALL BE IN THE NEUTRAL ZONE, LOCATED AT AN ANGLE OF APPROXIMATELY 10 DEG TO THE CENTERLINE OF THE PIPE PERPENDICULAR TO THE PLANE OF BENDING, AND AWAY FROM THE CENTER POINT OF THE RADIUS.
- ALL DIMENSIONS, ELEVATIONS AND ORIENTATIONS TO BE VERIFIED BY THE CONTRACTOR BEFORE UNDERTAKING ANY KIND OF FABRICATION, CONSTRUCTION AND INSTALLATION WORK AT SITE.
- FOR RISERS DETAIL SEE DRAWING # 2664-DT-002 & 2664-DT-003.

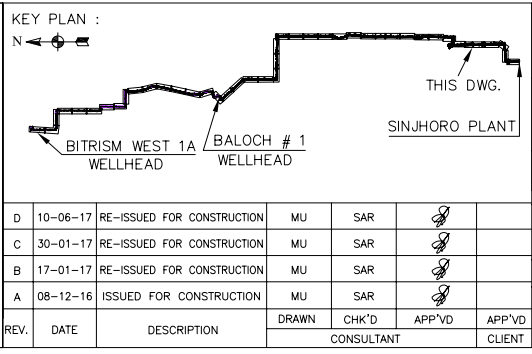

PC PETROCHEMICAL ENGINEERING CONSULTANTS
 C-2, BLOCK NO. 17, GULSHAN-E-IGBAL, NEAR NATIONAL STADIUM, KARACHI-75300, PAKISTAN.
 TEL: +92 (21) 34827780, 34961088. FAX: +92 21 34961089. E-Mail: contact@pcec.com.pk web site: www.pcec.com.pk

CLIENT: **OIL & GAS DEVELOPMENT COMPANY LTD.**

PROJECT: **DEVELOPMENT OF BITRISM WEST 1A**

TITLE: **PIPELINE ALIGNMENT DRAWING (27+750 TO 28+500)**

DRAWING NO.: **2664-PL-038**

SCALE: **H. SCALE:1/2000 V. SCALE:1/1000**

SHEET: **1 OF 1**

A3

RE-ISSUED FOR CONSTRUCTION

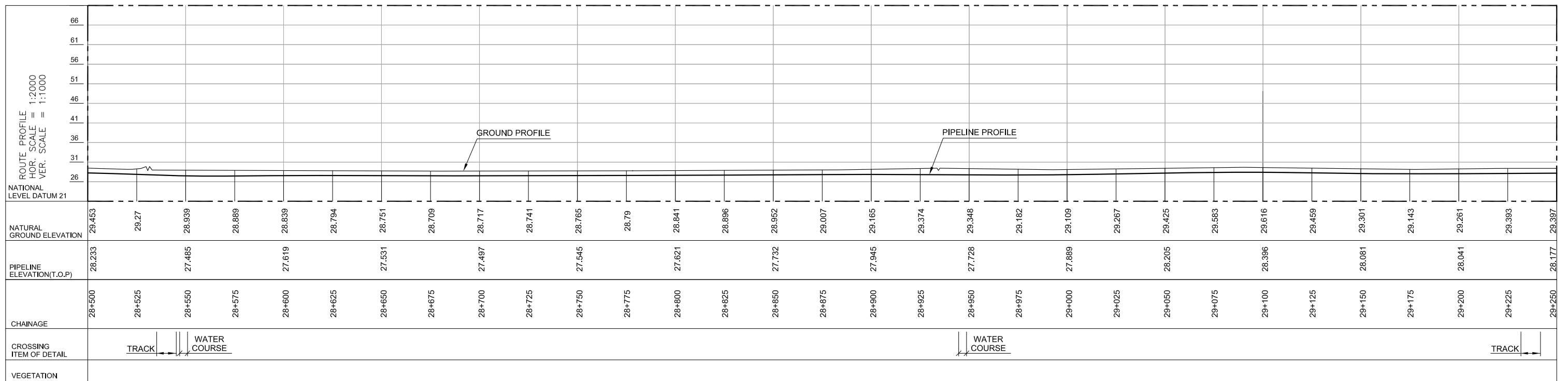
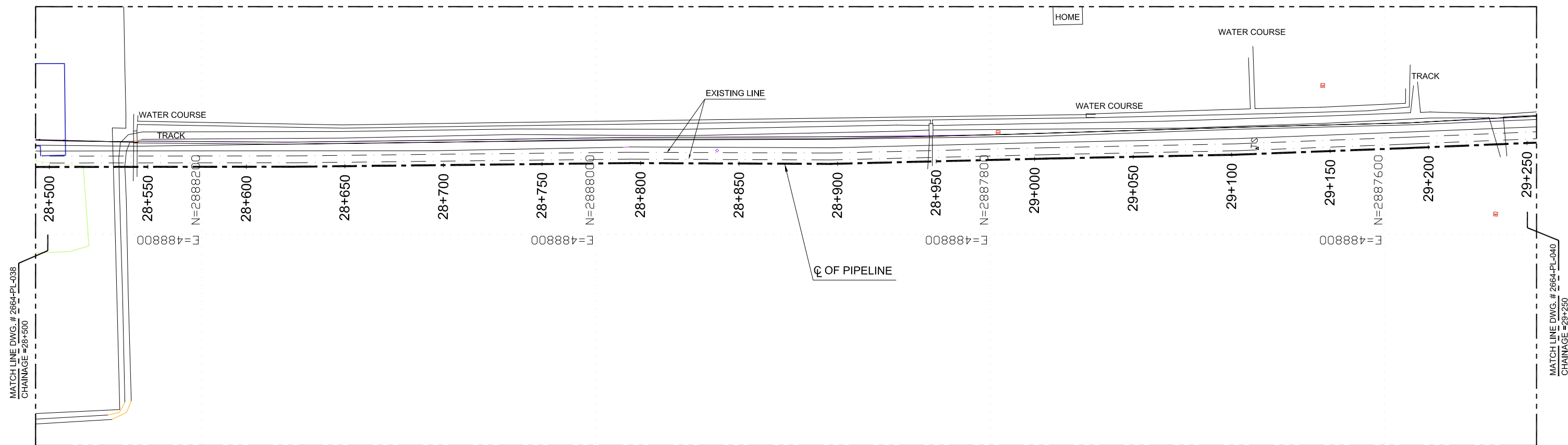
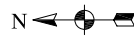

CONTROL:

SECONDARY SURVEY STATION (GPS)

TP TURNING POINT

LINE PIPE	8 INCH DIA, Sch. 80, CS, API 5L GR.X52.
LINE PIPE INSULATION	THREE LAYER POLYETHYLENE COATED
SPECIFICATION / CLASS	-
FLANGE RATING	CLASS 900# , RF
SERVICE LIMIT	-25 TO 150°F
HYDRO TEST PRESSURE	2250 PSIG.
SOIL COVER MIN.	4 ft

LEGEND :

RIVER / CANAL / DITCH	---
SURFACED ROAD	---
UNSURFACED ROAD	---
TRACK / PLATFORM	---
BANCH MARK	○
WALL	▬
FENCE	▬
PIPELINE PROFILE	---
ELECTRIC LINE	---
CUTTING AREA	▨

GROUND PROFILE	---
TREE (NON FRUIT)	⊙
MAJOR CONTOUR	---
MINOR CONTOUR	---
TOP OF HILL	⌒
TOE OF HILL	⌒
VALVE	⊕
WATER LINE	---
FILLING AREA	▨

ABBREVIATIONS:

AT	RADIO ANTENNA	PL	PIPELINE MARKER
CTM	BOUNDARY MARKER	PY	ELECTRICITY PYLON
BP	CATHODIC MARKER	RL	RUNWAY LIGHTS
EP	ELECTRICITY POLE	RM	RAILWAY MARKERS
FL	FLARE	SC	SIGNAL
KM	KILOMETER MARKER	SH	SEISMIC SHOT HOLE
LP	LAMP POST	SN	SIGN POST
LPM	LAND PARCEL MARKER	ST	SETTING OUT MARKER
MS	MAST	TP	TELEPHONE POLE
NV	NAVIGATION BEACON	WT	WATER STAND PIPE

NOTES :

- ALL DIMENSIONS ARE IN METER UNLESS OTHERWISE STATED.
- HORIZONTAL AND VERTICAL CURVATURE OF SUCH ELASTIC BENDS SHOULD IDEALLY NOT BE LESS THAN A RADIUS OF 500M. WHERE THIS CANNOT BE OBTAINED, THE CURVATURE OF THE CONSTRUCTED FLOWLINE SHALL NOT BE LESS THAN 200M, UNLESS COST-SET ARE USE.
- IF A LONGITUDINAL WELD IS PRESENT IN THE FLOWLINE PIPE, THE LONGITUDINAL WELD SHALL BE IN THE NEUTRAL ZONE, LOCATED AT AN ANGLE OF APPROXIMATELY 10 DEG TO THE CENTERLINE OF THE PIPE PERPENDICULAR TO THE PLANE OF BENDING, AND AWAY FROM THE CENTER POINT OF THE RADIUS.
- ALL DIMENSIONS, ELEVATIONS AND ORIENTATIONS TO BE VERIFIED BY THE CONTRACTOR BEFORE UNDERTAKING ANY KIND OF FABRICATION, CONSTRUCTION AND INSTALLATION WORK AT SITE.
- FOR RISERS DETAIL SEE DRAWING # 2664-DT-002 & 2664-DT-003.

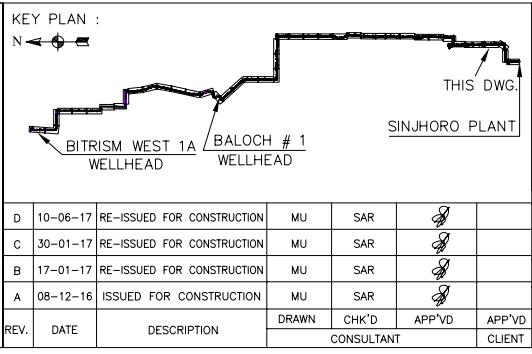

PC PETROCHEMICAL ENGINEERING CONSULTANTS
 C-2, BLOCK NO. 17, GULSHAN-E-IGBAL, NEAR NATIONAL STADIUM, KARACHI-75300, PAKISTAN.
 TEL: +92 (21) 34827780. 34961088. FAX: +92 21 34961089. E-Mail: contact@pcec.com.pk web site: www.pcec.com.pk

CLIENT: **OIL & GAS DEVELOPMENT COMPANY LTD.**

PROJECT: **DEVELOPMENT OF BITRISM WEST 1A**

TITLE: **PIPELINE ALIGNMENT DRAWING (28+500 TO 29+250)**

DRAWING NO. **2664-PL-039** SCALE: **1:2000** SHEET: **1 OF 1**

V. SCALE: **1:1000** A3

RE-ISSUED FOR CONSTRUCTION

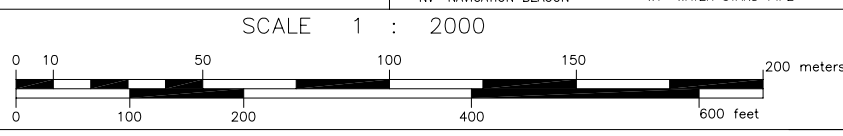

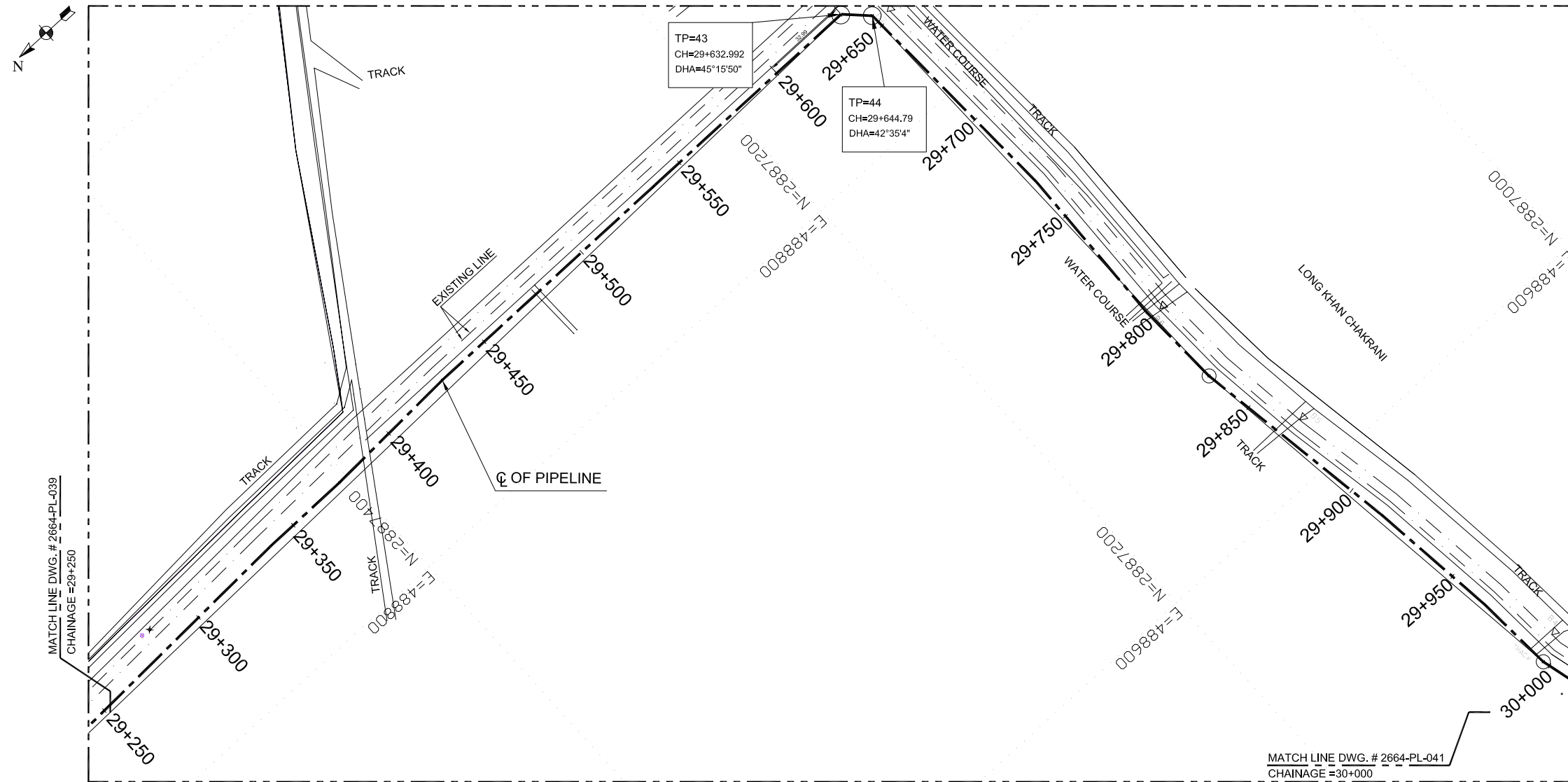

RE-ISSUED FOR CONSTRUCTION

NATURAL GROUND ELEVATION	ROUTE PROFILE		PIPELINE PROFILE
	HOR. SCALE = 1:2000	VER. SCALE = 1:1000	
29,397	28,177	30	28,177
29,445	28,217	30	28,217
29,437	28,2	30	28,2
29,429	28,177	30	28,177
29,42	28,162	30	28,162
29,412	28,177	30	28,177
29,414	28,249	30	28,249
29,426	28,267	30	28,267
29,382	28,317	30	28,317
29,45	28,567	30	28,567
29,402	28,562	30	28,562
29,463	28,567	30	28,567
29,469	28,593	30	28,593
29,474	28,538	30	28,538
29,487	29,407	30	29,407
29,505	29,485	30	29,485
29,537	29,435	30	29,435
29,557	29,384	30	29,384
29,562	29,457	30	29,457
29,567	29,478	30	29,478
29,593	29,491	30	29,491
29,538	29,526	30	29,526
29,407	29,528	30	29,528
29,485			
29,435			
29,384			
29,457			
29,478			
29,491			
29,526			
29,528			

CONTROL:	
SECONDARY SURVEY STATION (GPS)	
TP TURNING POINT	
LINE PIPE	8 INCH DIA, Sch. 80, CS, API 5L GR.X52
LINE PIPE INSULATION	THREE LAYER POLYETHYLENE COATED
SPECIFICATION / CLASS	-
FLANGE RATING	CLASS 900# , RF
SERVICE LIMIT	-25 TO 150°F
HYDRO TEST PRESSURE	2250 PSIG.
SOIL COVER MIN.	4 ft

LEGEND :	
RIVER / CANAL / DITCH	
SURFACED ROAD	
UNSURFACED ROAD	
TRACK / PLATFORM	
BANCH MARK	
WALL	
FENCE	
PIPELINE PROFILE	
ELECTRIC LINE	
CUTTING AREA	
GROUND PROFILE	
TREE (NON FRUIT)	
MAJOR CONTOUR	
MINOR CONTOUR	
TOP OF HILL	
TOE OF HILL	
VALVE	
WATER LINE	
FILLING AREA	

ABBREVIATIONS:	
AT RADIO ANTENNA	PL PIPELINE MARKER
CTM BOUNDARY MARKER	PY ELECTRICITY PYLON
BP CATHODIC MARKER	RL RUNWAY LIGHTS
EP ELECTRICITY POLE	RM RAILWAY MARKERS
FL FLARE	SG SIGNAL
KM KILOMETER MARKER	SH SEISMIC SHOT HOLE
LP LAMP POST	SN SIGN POST
LPM LAND PARCEL MARKER	ST SETTING OUT MARKER
MS MAST	TP TELEPHONE POLE
NV NAVIGATION BEACON	WT WATER STAND PIPE

NOTES :

- ALL DIMENSIONS ARE IN METER UNLESS OTHERWISE STATED.
- HORIZONTAL AND VERTICAL CURVATURE OF SUCH ELASTIC BENDS SHOULD IDEALLY NOT BE LESS THAN A RADIUS OF 500M. WHERE THIS CANNOT BE OBTAINED, THE CURVATURE OF THE CONSTRUCTED FLOWLINE SHALL NOT BE LESS THAN 200M, UNLESS COST-SET ARE USE.
- COLD-SET BENDS SHALL BE OF UNIFORM RADIUS, AND MINIMUM RADIUS OF CURVATURE SHALL BE 40X LINE PIPE DIAMETER.
- ALL COLD-SET BENDS SHALL BE TESTED BY THE CONTRACTOR AND WITNESS BY THE COMPANY, WITH A CALLER OF 97.5% OF THE NOMINAL INTERNAL DIAMETER PRIOR TO INSTALLATION.
- IF A LONGITUDINAL WELD IS PRESENT IN THE FLOWLINE PIPE, THE LONGITUDINAL WELD SHALL BE IN THE NEUTRAL ZONE, LOCATED AT AN ANGLE OF APPROXIMATELY 10 DEG TO THE CENTERLINE OF THE PIPE PERPENDICULAR TO THE PLANE OF BENDING, AND AWAY FROM THE CENTER POINT OF THE RADIUS.
- COLD-SET BENDS SHALL NOT BE MADE CLOSER THAN 2000mm FROM A CIRCUMFERENTIAL WELD. THE END OF EACH BEND SHALL BE STRAIGHT FOR AT LEAST 2000mm. THE CONTRACTOR SHALL LAYOUT AND MEASURE THE FLOWLINE PIPE FOR BENDING, TO KEEP THE LENGTH OF CUT-OFF TO A MINIMUM.
- ALL DIMENSIONS, ELEVATIONS AND ORIENTATIONS TO BE VERIFIED BY THE CONTRACTOR BEFORE UNDERTAKING ANY KIND OF FABRICATION, CONSTRUCTION AND INSTALLATION WORK AT SITE.
- FOR COLD BENDS DETAIL SEE DRAWING # 2664-DT-001.
- FOR RISERS DETAIL SEE DRAWING # 2664-DT-002 & 2664-DT-003.

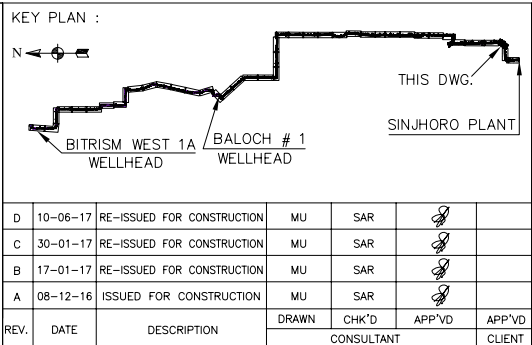

PC PETROCHEMICAL ENGINEERING CONSULTANTS
C-2, BLOCK NO. 17, GULSHAN-E-IGBAL, NEAR NATIONAL STADIUM, KARACHI-75300, PAKISTAN.
TEL: +92 (21) 34827780, 34961088. FAX: +92 21 34961089. E-Mail: contact@pec.com.pk web site: www.pec.com.pk

CLIENT: **OIL & GAS DEVELOPMENT COMPANY LTD.**

PROJECT: **DEVELOPMENT OF BITRISM WEST 1A**

TITLE: **PIPELINE ALIGNMENT DRAWING (29+250 TO 30+000)**

DRAWING NO.: **2664-PL-040**

SCALE: **1:2000**

SHEET: **1 OF 1**

V. SCALE: **1:1000**

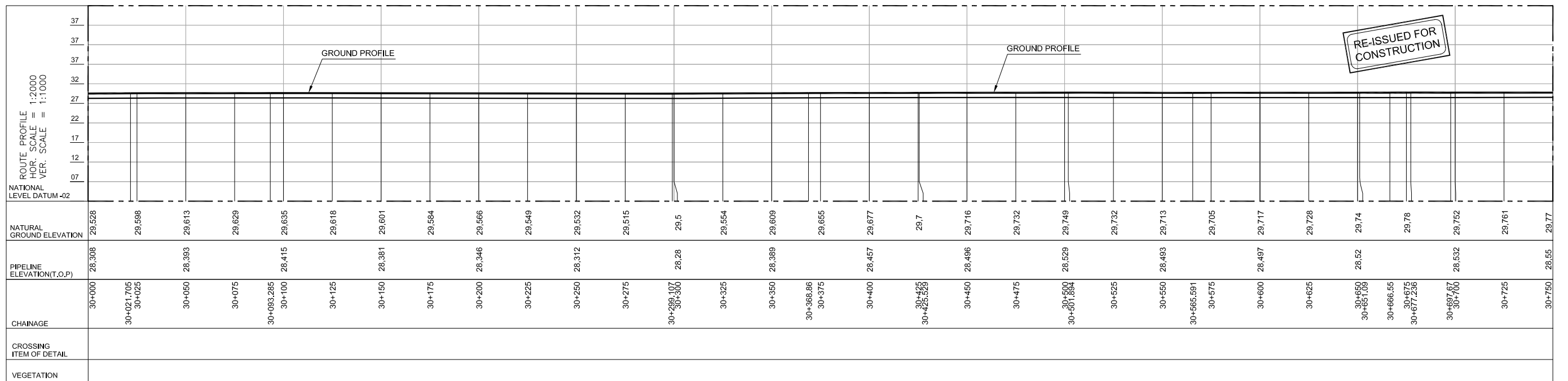
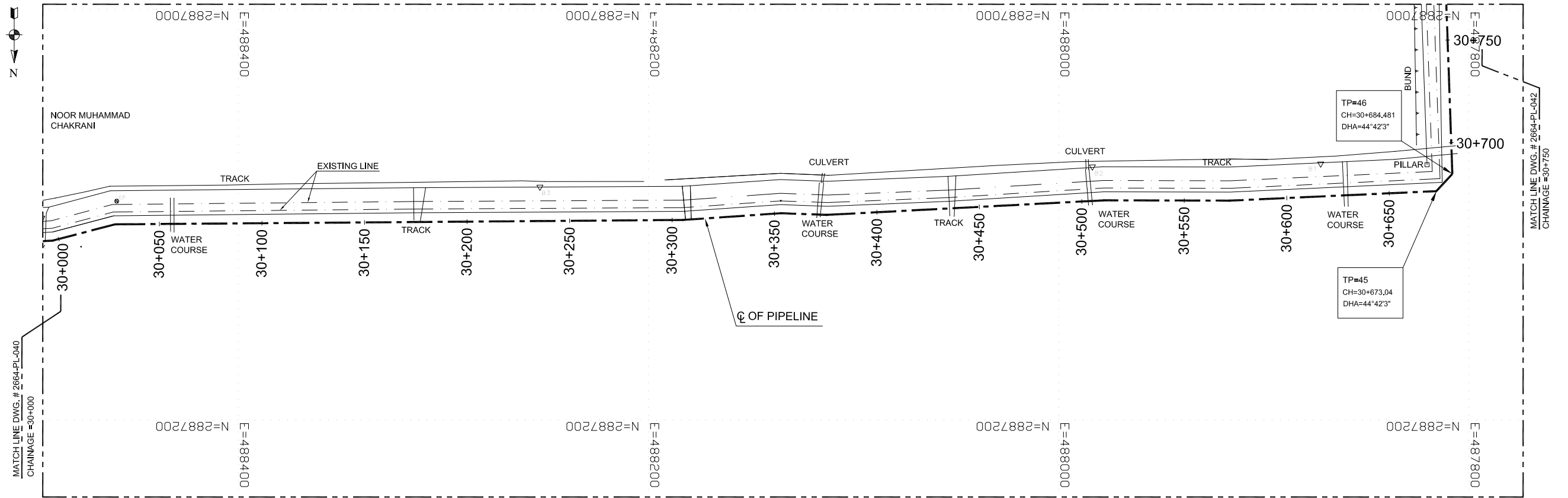

CONTROL:

SECONDARY SURVEY STATION (GPS)

TP TURNING POINT

LINE PIPE	8 INCH DIA. Sch. 80, CS, API 5L GR.X52
LINE PIPE INSULATION	THREE LAYER POLYETHYLENE COATED
SPECIFICATION / CLASS	-
FLANGE RATING	CLASS 900#, RF
SERVICE LIMIT	-25 TO 150°F 1800 PSIG.
HYDRO TEST PRESSURE	2250 PSIG.
SOIL COVER MIN.	4 ft

LEGEND :

RIVER / CANAL / DITCH	
SURFACED ROAD	
UNSURFACED ROAD	
TRACK / PLATFORM	
BANCH MARK	
WALL	
FENCE	
PIPELINE PROFILE	
ELECTRIC LINE	
CUTTING AREA	

ABBREVIATIONS:

AT	RADIO ANTENNA	PL	PIPELINE MARKER
CTM	BOUNDARY MARKER	PY	ELECTRICITY PYLON
BP	CATHODIC MARKER	RL	RUNWAY LIGHTS
EP	ELECTRICITY POLE	RM	RAILWAY MARKERS
FL	FLARE	SG	SIGNAL
KM	KILOMETER MARKER	SH	SEISMIC SHOT HOLE
LP	LAMP POST	SN	SIGN POST
LPM	LAND PARCEL MARKER	ST	SETTING OUT MARKER
MS	MAST	TP	TELEPHONE POLE
NV	NAVIGATION BEACON	WT	WATER STAND PIPE

- NOTES :
- ALL DIMENSIONS ARE IN METER UNLESS OTHERWISE STATED.
 - HORIZONTAL AND VERTICAL CURVATURE OF SUCH ELASTIC BENDS SHOULD IDEALLY NOT BE LESS THAN A RADIUS OF 50M WHERE THIS CANNOT BE OBTAINED, THE CURVATURE OF THE CONSTRUCTED FLOWLINE SHALL NOT BE LESS THAN 200M, UNLESS COST-SET ARE USE.
 - COLD-SET BENDS SHALL BE OF UNIFORM RADIUS, AND MINIMUM RADIUS OF CURVATURE SHALL BE ABOVE PIPE DIAMETER.
 - ALL COLD-SET BENDS SHALL BE TESTED BY THE CONTRACTOR AND WITNESS BY THE COMPANY, WITH A CALLIPER OF 97.5% OF THE NOMINAL INTERNAL DIAMETER PRIOR TO INSTALLATION.
 - IF A LONGITUDINAL WELD IS PRESENT IN THE FLOWLINE PIPE, THE LONGITUDINAL WELD SHALL BE IN THE NEUTRAL ZONE, LOCATED AT AN ANGLE OF APPROXIMATELY 10 DEG TO THE CENTERLINE OF THE PIPE PERPENDICULAR TO THE PLANE OF BENDING, AND AWAY FROM THE CENTER POINT OF THE RADIUS.
 - COLD-SET BENDS SHALL NOT BE MADE CLOSER THAN 2000mm FROM A CIRCUMFERENTIAL WELD. THE END OF EACH BEND SHALL BE STRAIGHT FOR AT LEAST 2000mm. THE CONTRACTOR SHALL LAYOUT AND MEASURE THE FLOWLINE PIPE FOR BENDING, TO KEEP THE LENGTH OF CUT-OFF TO A MINIMUM.
 - ALL DIMENSIONS, ELEVATIONS AND ORIENTATIONS TO BE VERIFIED BY THE CONTRACTOR BEFORE UNDERTAKING ANY KIND OF FABRICATION, CONSTRUCTION AND INSTALLATION WORK AT SITE.
 - FOR COLD BENDS DETAIL SEE DRAWING # 2664-DT-001.
 - FOR RISERS DETAIL SEE DRAWING # 2664-DT-002 & 2664-DT-003.

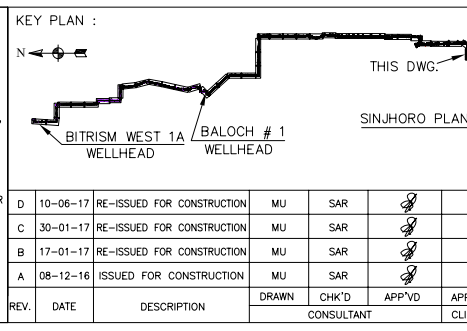

PC PETROCHEMICAL ENGINEERING CONSULTANTS

C-2, BLOCK NO. 17, GULSHAN-E-JOHAL, NEAR NATIONAL STADIUM, KARACHI-75300, PAKISTAN.
TEL: +92 (21) 34827780, 34961088. FAX: +92 21 34961089, E-Mail: contact@pcec.com.pk web site: www.pcec.com.pk

CLIENT: OIL & GAS DEVELOPMENT COMPANY LTD.

PROJECT: DEVELOPMENT OF BITRISM WEST 1A

TITLE: PIPELINE ALIGNMENT DRAWING (30+000 TO 30+750)

REV.	DATE	DESCRIPTION	DRAWN	CHK'D	APP'VD	APP'VD
D	10-06-17	RE-ISSUED FOR CONSTRUCTION	MU	SAR		
C	30-01-17	RE-ISSUED FOR CONSTRUCTION	MU	SAR		
B	17-01-17	RE-ISSUED FOR CONSTRUCTION	MU	SAR		
A	08-12-16	ISSUED FOR CONSTRUCTION	MU	SAR		

DRAWING NO. 2664-PL-041

SCALE: H. SCALE: 1/2000 V. SCALE: 1/1000

SHEET 1 OF 1 A3

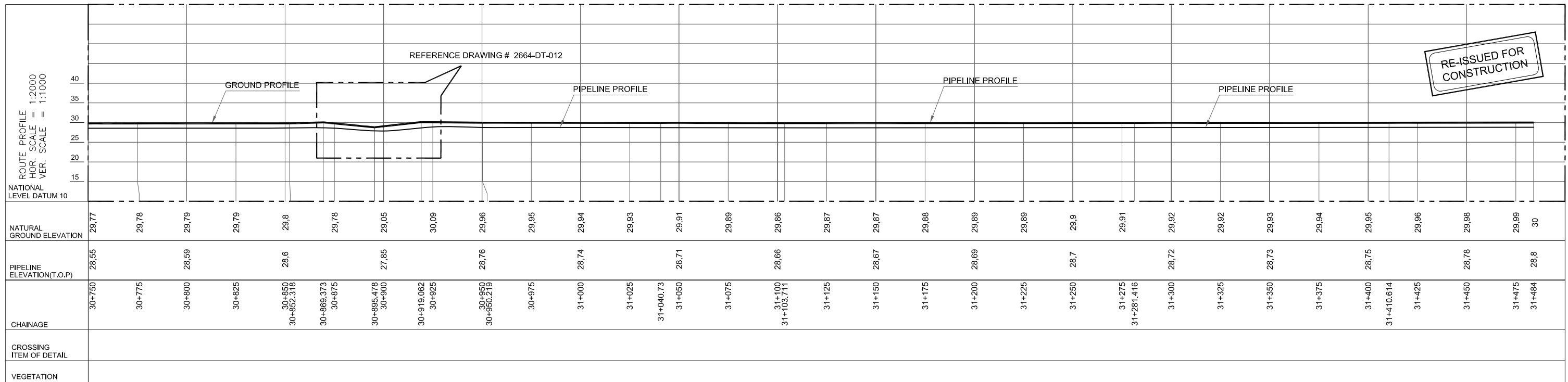
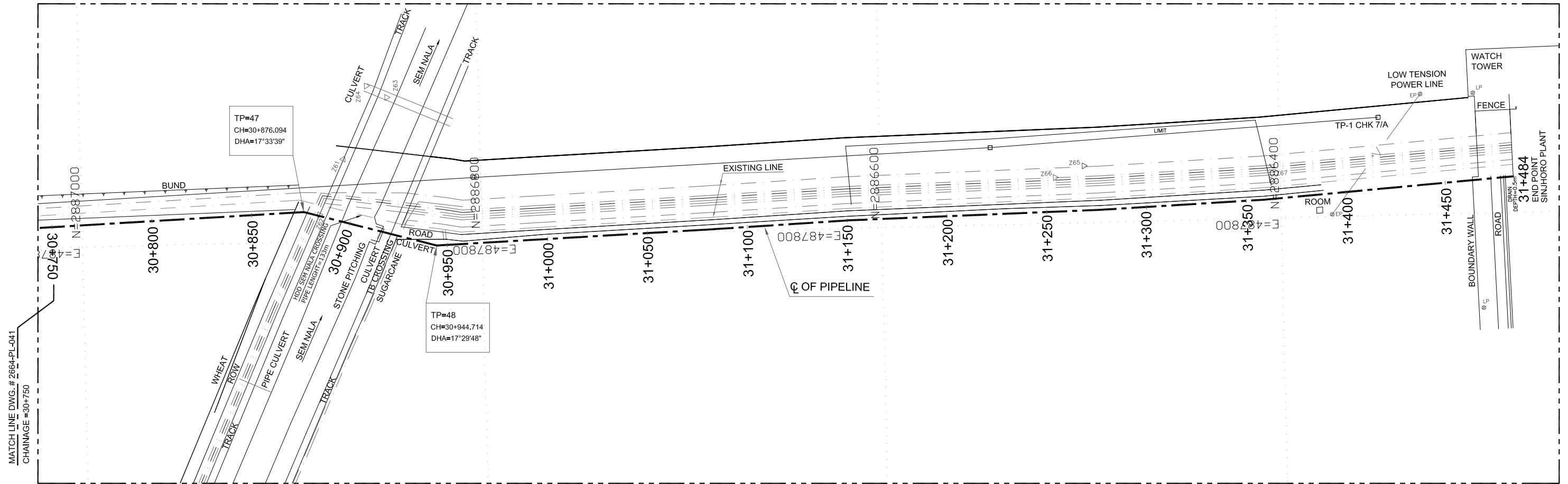

CONTROL:

SECONDARY SURVEY STATION (GPS)

TP TURNING POINT

LINE PIPE	8 INCH DIA, Sch. 80, CS, API 5L GR.X52
LINE PIPE INSULATION	THREE LAYER POLYETHYLENE COATED
SPECIFICATION / CLASS	-
FLANGE RATING	CLASS 900# , RF
SERVICE LIMIT	-25 TO 150°F
HYDRO TEST PRESSURE	1800 PSIG
SOIL COVER MIN.	2250 PSIG
	4 ft

LEGEND :

RIVER / CANAL / DITCH	
SURFACED ROAD	
UNSURFACED ROAD	
TRACK / PLATFORM	
BANCH MARK	
WALL	
FENCE	
PIPELINE PROFILE	
ELECTRIC LINE	
CUTTING AREA	
GROUND PROFILE	
TREE (NON FRUIT)	
MAJOR CONTOUR	
MINOR CONTOUR	
TOP OF HILL	
TOE OF HILL	
VALVE	
WATER LINE	
FILLING AREA	

ABBREVIATIONS:

AT	RADIO ANTENNA	PL	PIPELINE MARKER
CTM	BOUNDARY MARKER	PY	ELECTRICITY PYLON
BP	CATHODIC MARKER	RL	RUNWAY LIGHTS
EP	ELECTRICITY POLE	RM	RAILWAY MARKERS
FL	FLARE	SG	SIGNAL
KM	KILOMETER MARKER	SH	SEISMIC SHOT HOLE
LP	LAMP POST	SN	SIGN POST
LPM	LAND PARCEL MARKER	ST	SETTING OUT MARKER
MS	MAST	TP	TELEPHONE POLE
NV	NAVIGATION BEACON	WT	WATER STAND PIPE

NOTES :

- ALL DIMENSIONS ARE IN METER UNLESS OTHERWISE STATED.
- HORIZONTAL AND VERTICAL CURVATURE OF SUCH ELASTIC BENDS SHOULD IDEALLY NOT BE LESS THAN A RADIUS OF 500M. WHERE THIS CANNOT BE OBTAINED, THE CURVATURE OF THE CONSTRUCTED FLOWLINE SHALL NOT BE LESS THAN 200M, UNLESS COLD-SET ARE USE.
- COLD-SET BENDS SHALL BE OF UNIFORM RADIUS, AND MINIMUM RADIUS OF CURVATURE SHALL BE 40XLINE PIPE DIAMETER.
- ALL COLD-SET BENDS SHALL BE TESTED BY THE CONTRACTOR AND WITNESS BY THE COMPANY, WITH A CALLIPER OF 97.5% OF THE NOMINAL INTERNAL DIAMETER PRIOR TO INSTALLATION.
- IF A LONGITUDINAL WELD IS PRESENT IN THE FLOWLINE PIPE, THE LONGITUDINAL WELD SHALL BE IN THE NEUTRAL ZONE, LOCATED AT AN ANGLE OF APPROXIMATELY 10 DEG TO THE CENTERLINE OF THE PIPE PERPENDICULAR TO THE PLANE OF BENDING, AND AWAY FROM THE CENTER POINT OF THE RADIUS.
- COLD-SET BENDS SHALL NOT BE MADE CLOSER THAN 2000mm FROM A CIRCUMFERENTIAL WELD. THE END OF EACH BEND SHALL BE STRAIGHT FOR AT LEAST 2000mm. THE CONTRACTOR SHALL LAYOUT AND MEASURE THE FLOWLINE PIPE FOR BENDING, TO KEEP THE LENGTH OF CUT-OFF TO A MINIMUM.
- ALL DIMENSIONS, ELEVATIONS AND ORIENTATIONS TO BE VERIFIED BY THE CONTRACTOR BEFORE UNDERTAKING ANY KIND OF FABRICATION, CONSTRUCTION AND INSTALLATION WORK AT SITE.
- FOR COLD BENDS DETAIL SEE DRAWING # 2664-DT-001.
- FOR RISERS DETAIL SEE DRAWING # 2664-DT-002 & 2664-DT-003.

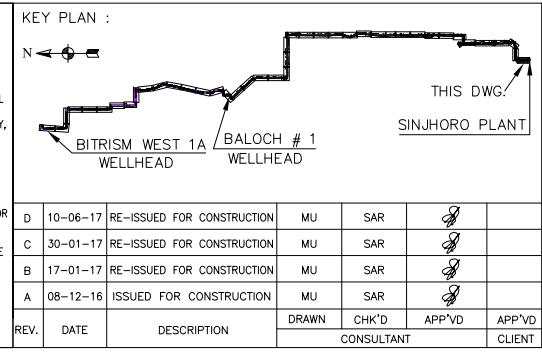

PC PETROCHEMICAL ENGINEERING CONSULTANTS
 C-2, BLOCK NO. 17, GULSHAN-E-IGBAL, NEAR NATIONAL STADIUM, KARACHI-75300, PAKISTAN.
 TEL: +92 (21) 34827780, 34961088. FAX: +92 21 34961089. E-Mail: contact@pcec.com.pk web site: www.pcec.com.pk

CLIENT: **OIL & GAS DEVELOPMENT COMPANY LTD.**

PROJECT: **DEVELOPMENT OF BITRISM WEST 1A**

TITLE: **PIPELINE ALIGNMENT DRAWING (30+000 TO 31+484)**

DRAWING NO.: **2664-PL-042**

SCALE: **H. SCALE:1/2000 V. SCALE:1/1000**

SHEET: **1 OF 1 A3**

Detail Drawing

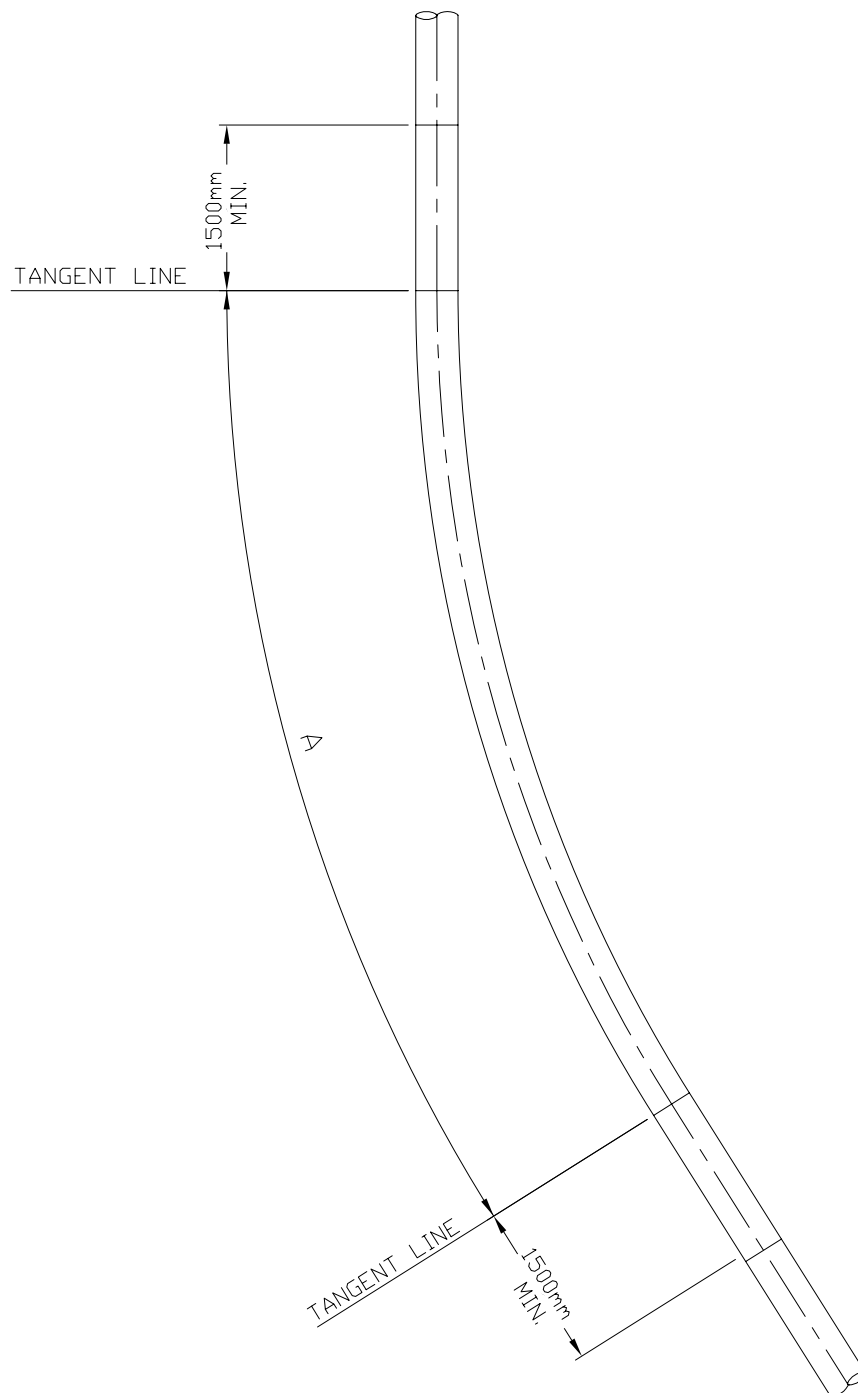

40D COLD BEND
FLOW LINE Ø8" - Sch. 80. CS, API 5L GR.X52.

BENDS	ANGLE	QUANTITY	LOCATION	PIPE LENGTH (mm)	A (mm)
TP=19	36°0'0"	1	11+169.54	8107	5107
TP=20	41°38'15"	1	11+183.38	8906	5906
TP=23	45°10'44"	1	11+802.65	9409	6409
TP=24	47°21'35"	1	11+808.154	9718	6718
TP=26	53°10'32"	1	11+970.901	10543	7543
TP=27	59°51'9"	1	12+000.498	11490	8490
TP=29	45°21'58"	1	15+201.68	9435	6435
TP=30	45°0'0"	1	15+222.62	9383	6383
TP=31	44°22'33"	1	17+379.75	9295	6295
TP=32	45°0'0"	1	17+444.01	9383	6383
TP=39	45°0'0"	1	26+501.15	9383	6383
TP=40	46°11'2"	1	26+515.57	9551	6551
TP=43	45°15'50"	1	29+632.992	9420	6420
TP=44	42°35'4"	1	29+644.79	9040	6040
TP=45	44°42'3"	1	30+673.04	6415	3415
TP=46	44°42'3"	1	30+684.481	6415	3415
TP=47	17°33'39"	1	30+876.094	7915	4915
TP=48	17°29'48"	1	30+944.714	7820	4820

LINE PIPE	8 INCH DIA, Sch. 80, CS, API 5L GR.X52.
EXTERIOR COATING	THREE LAYER POLYETHYLENE COATED
SPECIFICATION / CLASS	-
FLANGE RATING	CLASS 900# , RF
SERVICE LIMIT	-25 TO 150°F
	1800 PSIG.
HYDRO TEST PRESSURE	2000 PSIG.

NOTE:

- ALL DIMENSIONS ARE IN MILIMETER UNLESS OTHERWISE STATED.
- COLD-SET BENDS SHALL BE OF UNIFORM RADIUS, AND MINIMUM RADIUS OF CURVATURE SHALL BE 40xLINE PIPE DIAMETER.
- ALL COLD-SET BENDS SHALL BE TESTED BY THE CONTRACTOR AND WITNESS BY THE COMPANY, WITH A CALLIPER OF 97.5% OF THE NOMINAL INTERNAL DIAMETER PRIOR TO INSTALLATION.
- COLD-SET BENDS SHALL NOT BE MADE CLOSER THAN 1500mm FROM A CIRCUMFERENTIAL WELD. THE END OF EACH BEND SHALL BE STRAIGHT FOR AT LEAST 1500mm. THE CONTRACTOR SHALL LAYOUT AND MEASURE THE FLOWLINE PIPE FOR BENDING, TO KEEP THE LENGTH OF CUT-OFF TO A MINIMUM.
- ALL DIMENSIONS, ELEVATIONS AND ORIENTATIONS TO BE VERIFIED BY THE CONTRACTOR BEFORE UNDERTAKING ANY KIND OF FABRICATION, CONSTRUCTION AND INSTALLATION WORK AT SITE.

REFERENCE DRAWINGS

S.NO	DESCRIPTION	DWG. NO
1	FLOWLINE ALIGNMENT DRAWING	2664-PL-001 TO 042

RE-ISSUED FOR CONSTRUCTION

REV.	DATE	DESCRIPTION	DRAWN	CHK'D	APP'VD	APP'VD
			CONSULTANT		CLIENT	
D	10-06-17	RE-ISSUED FOR CONSTRUCTION	MU	SAR		
C	30-01-17	RE-ISSUED FOR CONSTRUCTION	MU	SAR		
B	17-01-17	RE-ISSUED FOR CONSTRUCTION	MU	SAR		
A	26-11-16	ISSUED FOR CONSTRUCTION	AHK	SAR		

PE PETROCHEMICAL ENGINEERING CONSULTANTS
 C-2, BLOCK NO. 17, GULSHAN-E-IQBAL, NEAR NATIONAL STADIUM, KARACHI-75300, PAKISTAN.
 TEL: +92 (21) 34827780, 34961088, FAX: +92 21 34961089, E-Mail: contact@pecc.com.pk web site: www.pecc.com.pk

CLIENT **OIL & GAS DEVELOPMENT COMPANY LTD.**

PROJECT **DEVELOPMENT OF BITRISM WEST 1A**

TITLE **Ø8" FLOWLINE COLD BENDS**

DRAWING NO.	SHEET		REV.
	NO.	OF	
2664-DT-001	1	1	D

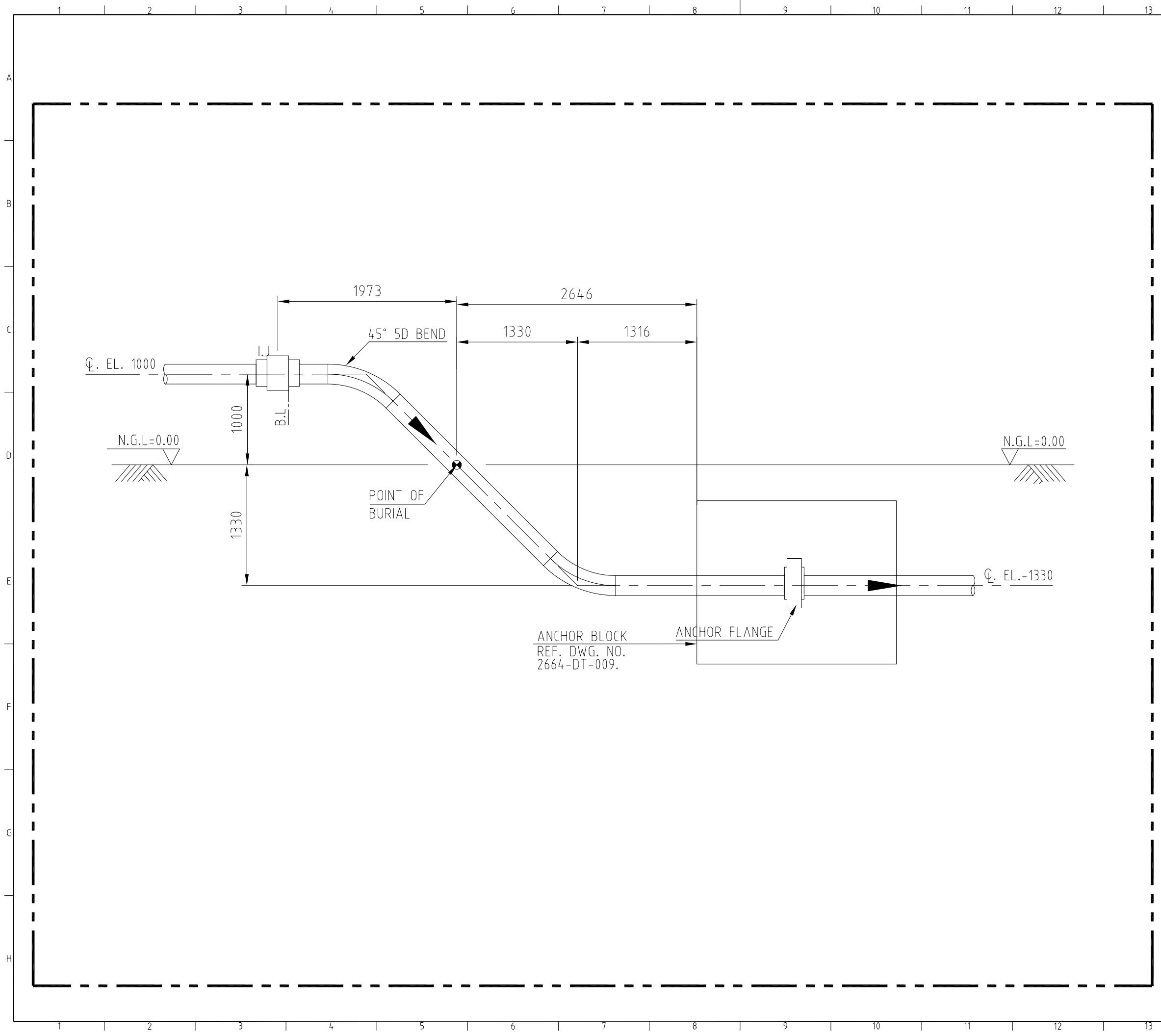

NOTES

1. ALL DIMENSIONS ARE IN MM UNLESS OTHERWISE STATED.
2. ALL DIMENSIONS, ELEVATIONS AND ORIENTATIONS TO BE VERIFIED BY THE CONTRACTOR BEFORE UNDERTAKING ANY KIND OF FABRICATION, CONSTRUCTION AND INSTALLATION WORK AT SITE.
3. TWO NOS. 45°, 5D HOT BEND ARE USED AT EACH RISER.

REFERENCE DRAWINGS

S.NO	DESCRIPTION	DWG. NO	REMARKS
1	FLOWLINE ALIGNMENT DRAWING	2664-PL-001	-

RE-ISSUED FOR CONSTRUCTION

B	17/01/17	RE-ISSUED FOR CONSTRUCTION	MU	SAR		
A	08/12/16	ISSUED FOR CONSTRUCTION	MU	SAR		
2	26/11/16	RE-ISSUED FOR REVIEW	AHK	SAR		
1	17/08/16	RE-ISSUED FOR REVIEW	MK	SAR		
0	25/07/16	ISSUED FOR REVIEW	MK	SAR		
REV.	DATE	DESCRIPTION	DRAWN	CHK'D	APP'VD	APP'VD
			CONSULTANT	CONSULTANT	CLIENT	CLIENT

PC PETROCHEMICAL ENGINEERING CONSULTANTS
 C-2, BLOCK NO. 17, GULSHAN-E-IGBAL, NEAR NATIONAL STADIUM, KARACHI-75300, PAKISTAN.
 TEL: +92 (21) 34827780, 34961088, FAX: +92 21 34961089, E-Mail: contact@pcec.com.pk web site: www.pcec.com.pk

CLIENT OIL & GAS DEVELOPMENT COMPANY LTD.

PROJECT
DEVELOPMENT OF BITRISM WEST 1A

TITLE
Ø8" FLOWLINE RISER

DRAWING NO.	SHEET	REV.
2664-DT-002	NO. OF	B
	1 1	

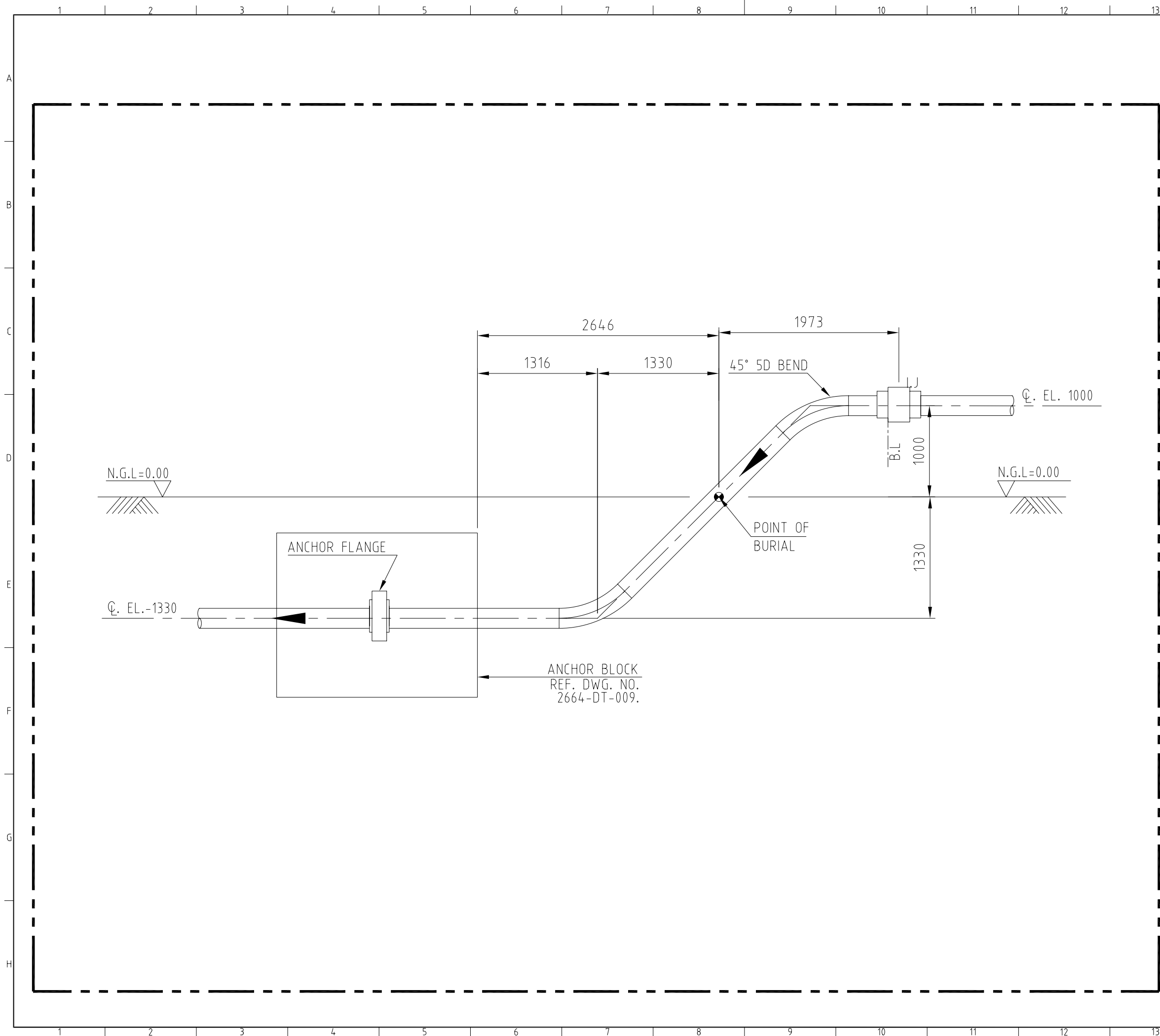

NOTES

1. ALL DIMENSIONS ARE IN MM UNLESS OTHERWISE STATED.
2. ALL DIMENSIONS, ELEVATIONS AND ORIENTATIONS TO BE VERIFIED BY THE CONTRACTOR BEFORE UNDERTAKING ANY KIND OF FABRICATION, CONSTRUCTION AND INSTALLATION WORK AT SITE.
3. TWO NOS. 45°, 5D HOT BEND ARE USED AT EACH RISER.

REFERENCE DRAWINGS

S.NO	DESCRIPTION	DWG. NO	REMARKS
1	FLOWLINE ALIGNMENT DRAWING	2664-PL-041	-

RE-ISSUED FOR CONSTRUCTION

B	17/01/17	RE-ISSUED FOR CONSTRUCTION	MU	SAR		
A	08/12/16	ISSUED FOR CONSTRUCTION	MU	SAR		
2	26/11/16	RE-ISSUED FOR REVIEW	AHK	SAR		
1	17/08/16	RE-ISSUED FOR REVIEW	MK	SAR		
0	25/07/16	ISSUED FOR REVIEW	MK	SAR		
REV.	DATE	DESCRIPTION	DRAWN	CHK'D	APP'VD	APP'VD
			CONSULTANT		CLIENT	

PC PETROCHEMICAL ENGINEERING CONSULTANTS
 C-2, BLOCK NO. 17, GULSHAN-E-IGBAL, NEAR NATIONAL STADIUM, KARACHI-75300, PAKISTAN.
 TEL: +92 (21) 34827780, 34961088, FAX: +92 21 34961089, E-Mail: contact@pcec.com.pk web site: www.pcec.com.pk

CLIENT OIL & GAS DEVELOPMENT COMPANY LTD.

PROJECT
DEVELOPMENT OF BITRISM WEST 1A

TITLE
Ø8" FLOWLINE RISER

DRAWING NO.	SHEET	REV.
2664-DT-003	NO. OF	B
	1 1	

- NOTES:**
1. ALL DIMENSIONS ARE IN MILLIMETRE UNLESS OTHERWISE SPECIFIED.
 2. PIPELINE COVER BEYOND THE CROSSING SHALL BE MIN. 1.0m AND ELASTIC BEND SHALL BE USED TO ACHIEVE THE SAME.
 3. PIPELINE IDENTIFICATION SLABS SHALL BE PROVIDED AT THE CROSSING LOCATION
 4. IF THE DEPTH OF THE EXISTING UNDERGROUND SERVICE IS BELOW 2.5m, THEN THE PROPOSED PIPELINE MAY BE TAKEN OVER THE TOP OF THE EXISTING SERVICE.
 5. THE OWNER OF THE EXISTING LINE SHALL BE NOTIFIED IN SUFFICIENT TIME, TO WITNESS EXCAVATION AND INSTALLATION.
 6. PRIOR TO EXCAVATION, THE EXISTING LINE SHALL BE EXACTLY LOCATED AND EXPOSED BY HAND TOOLS.
 7. TEMPORARY SUPPORTS SHALL BE PROVIDED FOR EXISTING PIPELINE DURING CONSTRUCTION TO ENSURE THAT PIPELINE ALWAYS REMAINS ADEQUATELY SUPPORTED, SUPPORTING ARRANGEMENT SHALL BE AGREED WITH THE OWNER OF EXISTING PIPELINE.

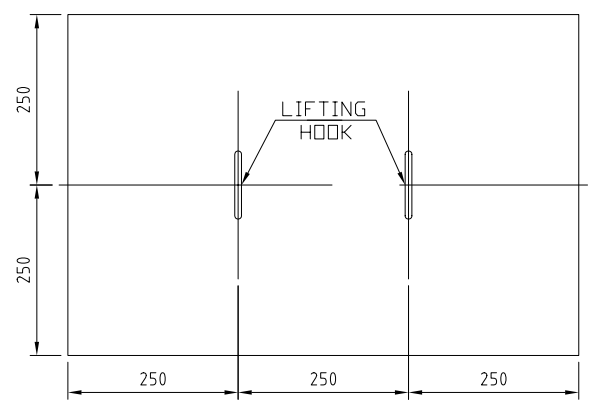
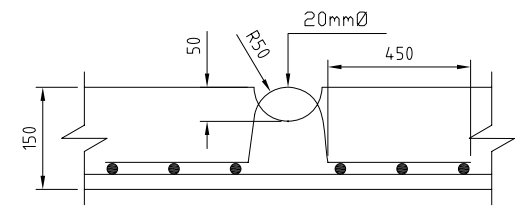
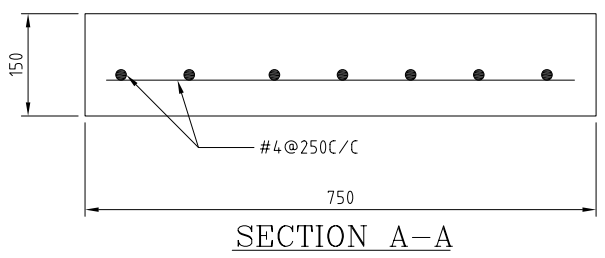
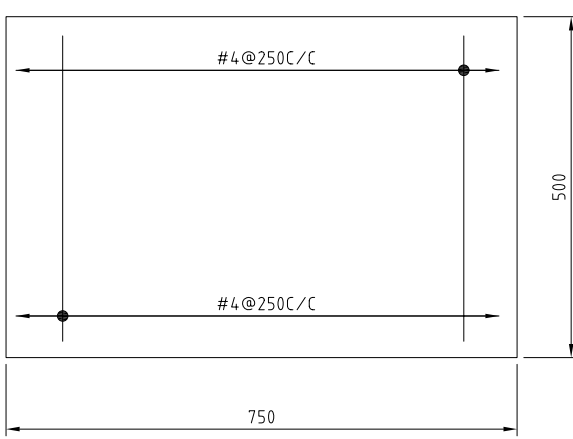
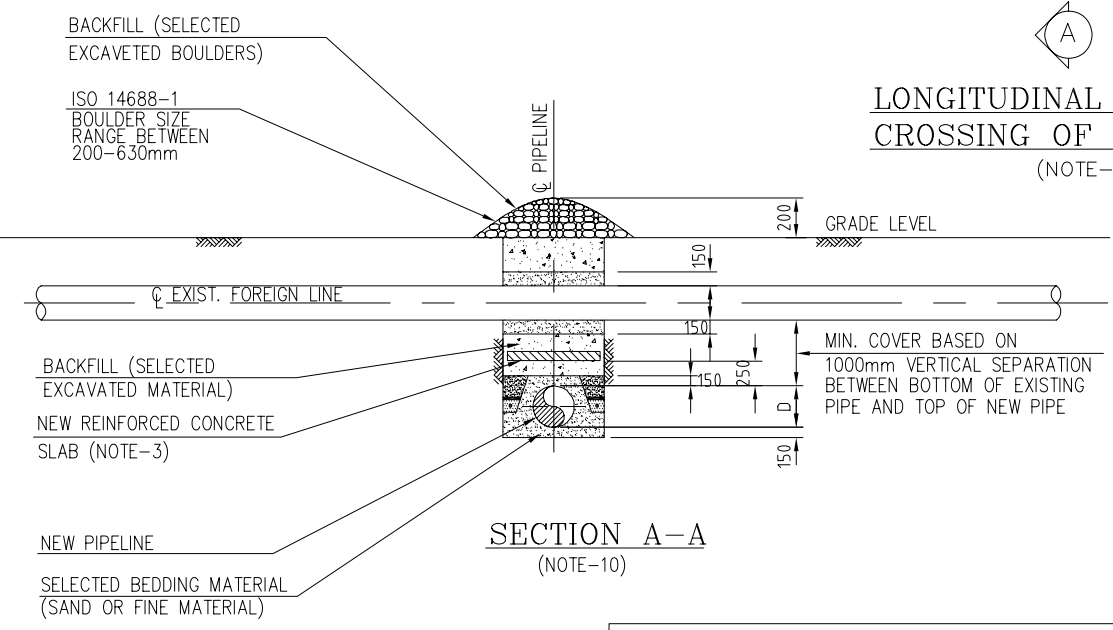
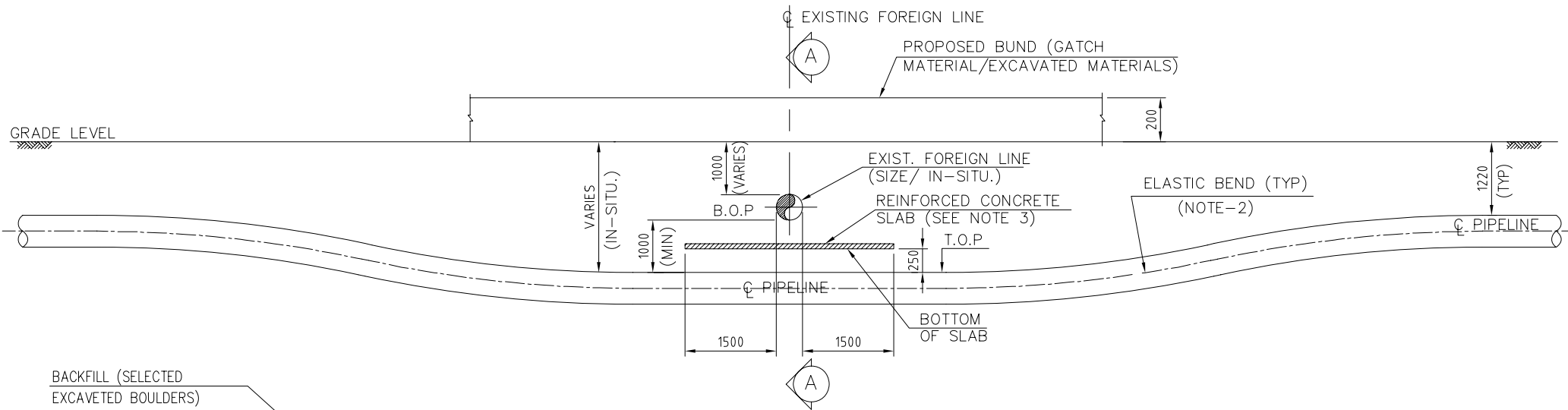

RE-ISSUED FOR CONSTRUCTION

REV.	DATE	DESCRIPTION	DRAWN	CHK'D	APP'VD	APP'VD
			CONSULTANT		CLIENT	
C	30/01/17	RE-ISSUED FOR CONSTRUCTION	MU	SAR		
B	17/01/17	RE-ISSUED FOR CONSTRUCTION	MU	SAR		
A	08/12/16	ISSUED FOR CONSTRUCTION	MU	SAR		
2	26/11/16	RE-ISSUED FOR REVIEW	AHK	SAR		
1	17/08/16	RE-ISSUED FOR REVIEW	MK	SAR		
0	25/07/16	ISSUED FOR REVIEW	MK	SAR		

PC PETROCHEMICAL ENGINEERING CONSULTANTS
 C-2, BLOCK NO. 17, GULSHAN-E-IQBAL, NEAR NATIONAL STADIUM, KARACHI-75300. PAKISTAN
 TEL: +92 (21) 34827780, 34961088, FAX: +92 21 34961089, E-Mail: contact@pcec.com.pk web site: www.pcec.com.pk

CLIENT **OIL & GAS DEVELOPMENT COMPANY LTD.**

PROJECT **DEVELOPMENT OF BITRISM WEST 1A**

TITLE **TYPICAL PIPELINE CROSSING BELOW EXISTING UNDERGROUND PIPELINE**

DRAWING NO.	SHEET	REV.
2655-DT-004	NO.	OF
	1	1

1 2 3 4 5 6 7 8 9 10 11 12 13 14 15 16

A B C D E F G H I J K

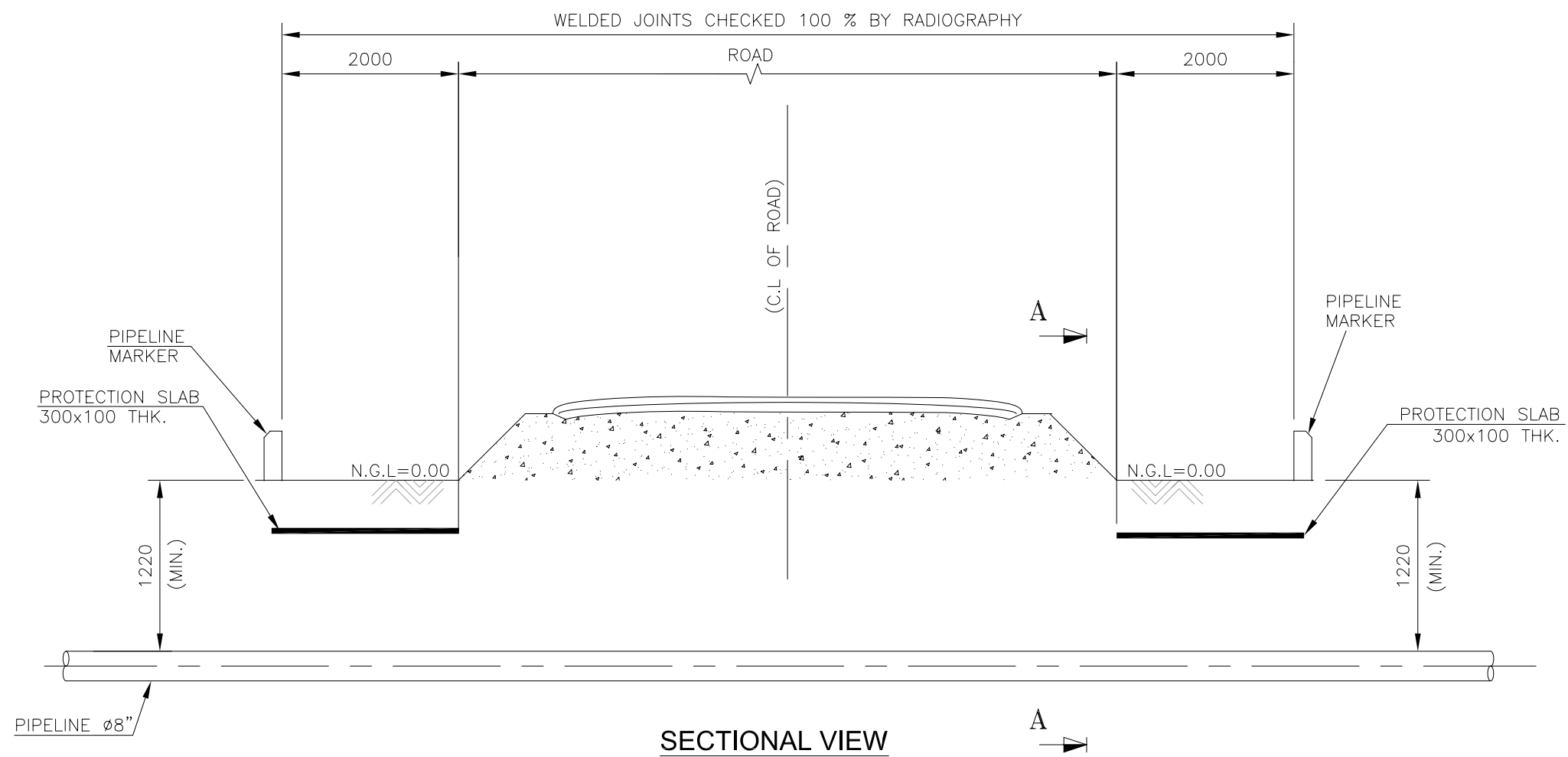

RE-ISSUED FOR CONSTRUCTION

NOTES :

1. ALL DIMENSIONS ARE IN mm. UNLESS OTHERWISE STATED.
2. BACKFILL MATERIAL WILL BE COMPACTED.
3. THE PAVEMENT WILL BE RESTORED IN ACCORDANCE WITH THE RECOMMENDATION OF THE CONCERNED DEPARTMENT.

REV.	DATE	DESCRIPTION	DRAWN	CHK'D	APP'VD	APP'VD
			CONSULTANT			CLIENT
B	16/03/17	RE-ISSUED FOR CONSTRUCTION	MU	SAR		
A	08/12/16	ISSUED FOR CONSTRUCTION	MU	SAR		
2	26/11/16	RE-ISSUED FOR REVIEW	AHK	SAR		
1	17/08/16	RE-ISSUED FOR REVIEW	MK	SAR		
0	25/07/16	ISSUED FOR REVIEW	MK	SAR		

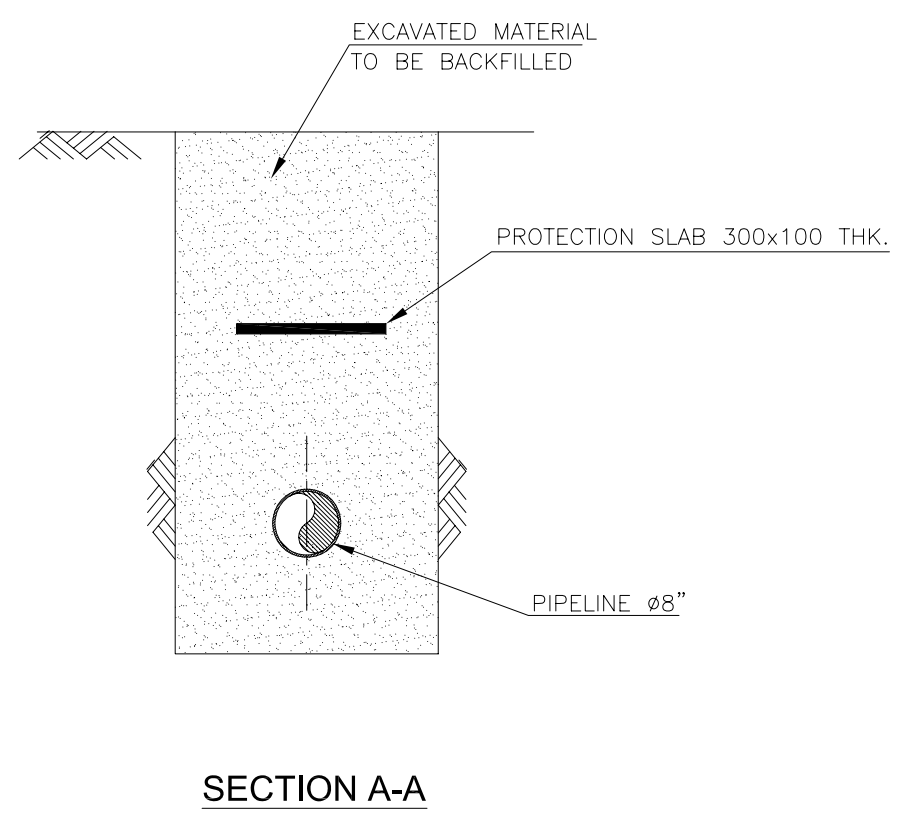

PC PETROCHEMICAL ENGINEERING CONSULTANTS
 C-2, BLOCK NO. 17, GULSHAN-E-IQBAL, NEAR NATIONAL STADIUM, KARACHI-75300. PAKISTAN.
 TEL: +92 (21) 34827780, 34961088, FAX: +92 21 34961089, E-Mail: contact@pcec.com.pk web site: www.pcec.com.pk

CLIENT
 OIL & GAS DEVELOPMENT COMPANY LTD.

PROJECT
 DEVELOPMENT OF BITRISM WEST 1A

TITLE
 TYPICAL ROAD CROSSING (THRUST BORE)

DRAWING NO.	SHEET	REV.
	NO. OF	
2655-DT-006	1 1	B

1 2 3 4 5 6 7 8 9 10 11 12 13 14 15 16

A B C D E F G H I J K

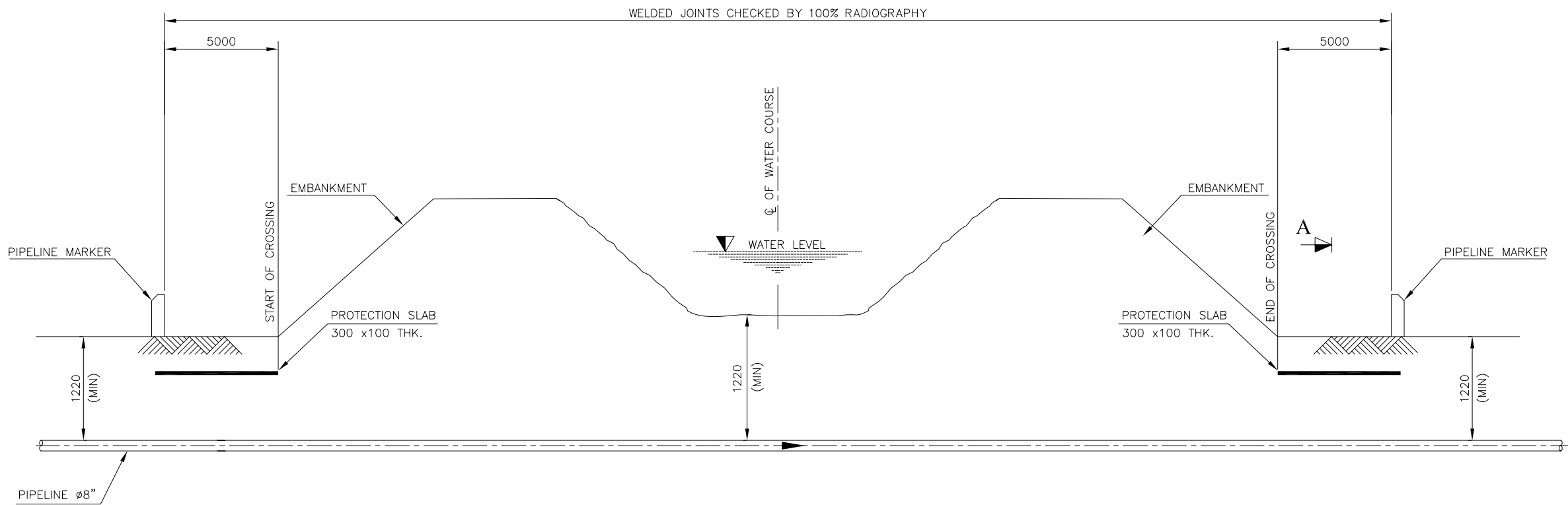

SECTIONAL VIEW

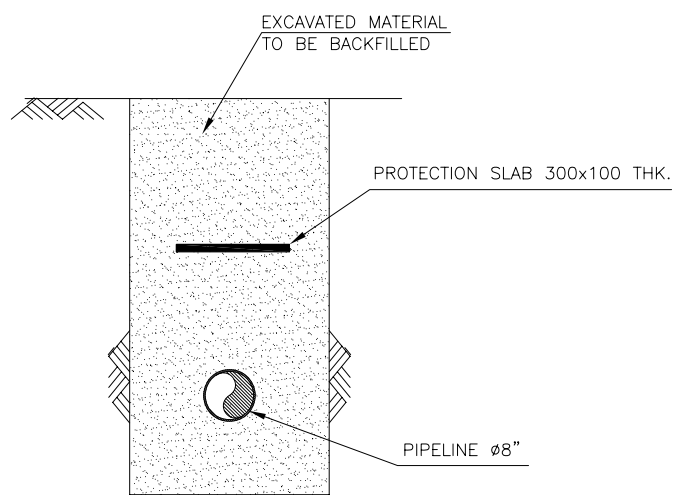

SECTION A-A

RE-ISSUED FOR CONSTRUCTION

NOTES:-

1. ALL DIMENSIONS ARE IN MM UNLESS OTHERWISE STATED.
2. PIPELINE TO BE BACKFILLED WITH TRENCH SOIL. SOIL SHOULD BE FREE FROM SHARP ROCKY/STONE. THIS MATERIAL WILL BE COMPACTED AND LEVELLED.

REV.	DATE	DESCRIPTION	DRAWN	CHK'D	APP'VD	APP'VD
			CONSULTANT	CONSULTANT	CONSULTANT	CLIENT
B	16/03/17	RE-ISSUED FOR CONSTRUCTION	MU	SAR		
A	08/12/16	ISSUED FOR CONSTRUCTION	MU	SAR		
2	26/11/16	RE-ISSUED FOR REVIEW	AHK	SAR		
1	17/08/16	RE-ISSUED FOR REVIEW	MK	SAR		
0	25/07/16	ISSUED FOR REVIEW	MK	SAR		

PC PETROCHEMICAL ENGINEERING CONSULTANTS
 C-2, BLOCK NO. 17, GULSHAN-E-IQBAL, NEAR NATIONAL STADIUM, KARACHI-75300. PAKISTAN
 TEL: +92 (21) 34827780, 34961088, FAX: +92 21 34961089, E-Mail: contact@pcec.com.pk web site: www.pcec.com.pk

CLIENT

OIL & GAS DEVELOPMENT COMPANY LTD.

PROJECT
DEVELOPMENT OF BITRISM WEST 1A

TITLE
**ø8" FLOWLINE
 TYPICAL WATER COURSE CROSSING DETAIL**

DRAWING NO.	SHEET NO.	REV.
2664-DT-007	1	B
	1	

FRONT SIDE
PIPELINE WARNING SIGN.

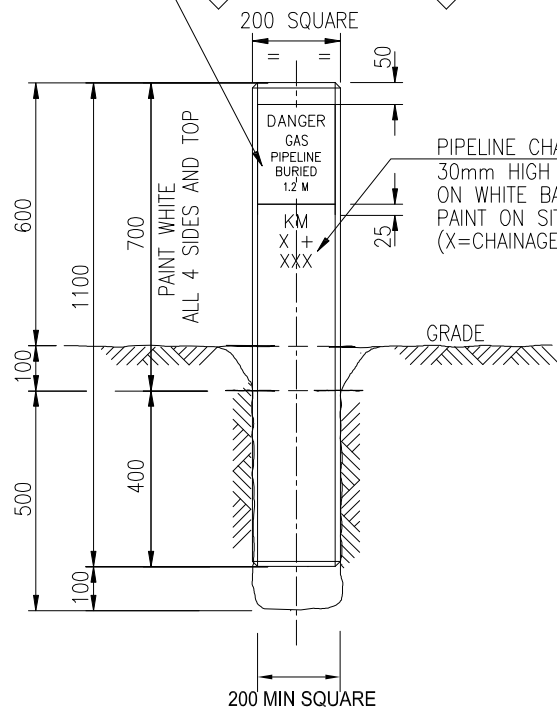

ELEVATION - FRONT SIDE
MARKER POST
LOOKING IN DIRECTION OF PIPELINE FLOW

PIPELINE CHAINAGE IN METRES.
30mm HIGH BLACK LETTERING
ON WHITE BACKGROUND.
PAINT ON SITE
(X=CHAINAGE)

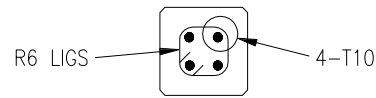

SECTION B-B

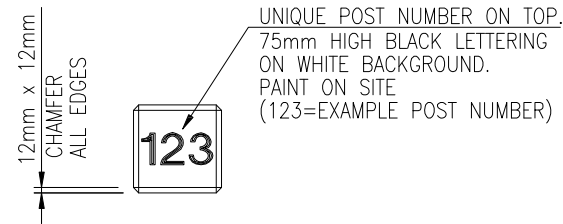

SECTION A-A

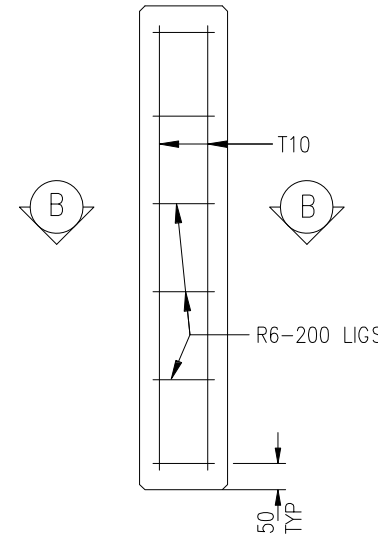

**REINFORCEMENT
MARKER POST**

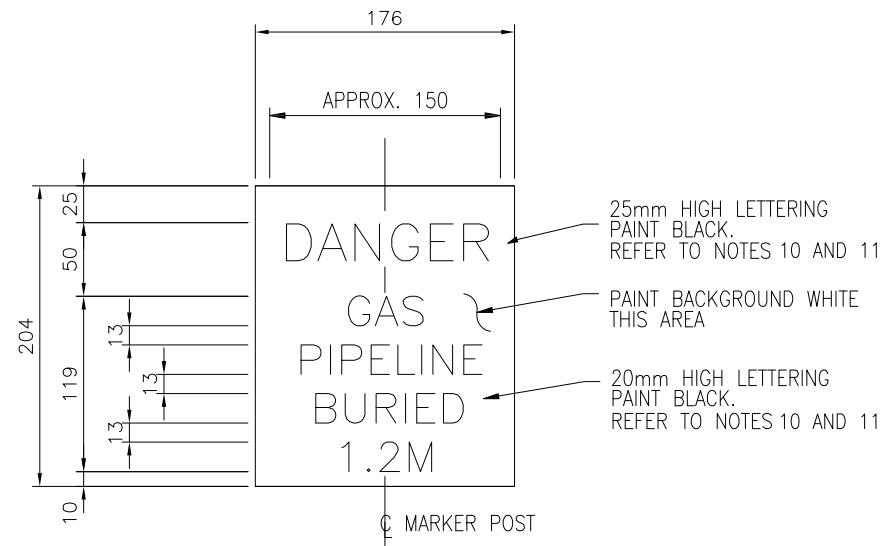

TYPICAL GAS PIPELINE SIGN

NOTES:

- UNLESS OTHERWISE SPECIFIED ALL DIMENSIONS ARE IN MILLIMETERS.
- ALL CONCRETE WORK SHALL BE IN ACCORDANCE WITH PROJECT SPECIFICATION.
- ALL CONCRETE SHALL BE GRADE C35 MINIMUM.
- MINIMUM REINFORCEMENT COVER FOR CONCRETE IS 45mm.
- PIPELINE MARKERS SHALL BE INSTALLED IN LOCATIONS AS DETERMINED BY THE CONTRACTOR.
- EXACT LOCATION OF PIPELINE MARKERS SHALL BE DETERMINED ON SITE.
- PIPELINE MARKERS SHALL BE INSTALLED AT EVERY 500.0m. IN POPULATED AND INDUSTRIAL AREAS, PIPELINE MARKERS SHALL BE INSTALLED EVERY 250.0m.
- CONCRETE PIPELINE MARKERS SHALL BE INSTALLED DIRECTLY ABOVE THE PIPELINE AT ALL TRACK, WATERCOURSE AND SERVICE CROSSINGS.
- AT ALL LOCATIONS OTHER THAN IN NOTE- 8, PIPELINE MARKERS SHALL BE PLACED 500mm TO THE LEFT OF THE PIPELINE WHEN LOOKING IN THE DIRECTION OF THE FLOW.
- LETTERING INTERCHARACTER SPACING SHALL BE 0.75 TO 1.0 X LETTER HEIGHT UNLESS NOTED OTHERWISE.
- PAINT TYPE TO BE APPROVED BY COMPANY PRIOR TO USE. PAINT SHALL BE UV RESISTANT AND SUITABLE FOR UNPROTECTED OUTDOOR LOCATIONS.
- PIPELINE MARKERS SHALL BE INSTALLED AT INTERVAL OF 500M, UPSTREAM AND DOWNSTREAM OF EACH CROSSING AND AT TURNING POINT.
- POST WEIGHT (EXCL FOOTING) APPROX 110kg EACH.
- REINFORCEMENT NOTATION.

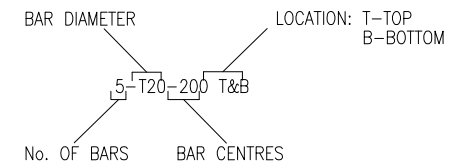

**RE-ISSUED FOR
CONSTRUCTION**

C	11/03/17	RE-ISSUED FOR CONSTRUCTION	MU	SAR		
B	17/01/17	RE-ISSUED FOR CONSTRUCTION	MU	SAR		
A	26/11/16	ISSUED FOR CONSTRUCTION	AHK	SAR		
1	17/08/16	RE-ISSUED FOR REVIEW	MK	SAR		
0	25/07/16	ISSUED FOR REVIEW	MK	SAR		
REV.	DATE	DESCRIPTION	DRAWN	CHK'D	APP'VD	APP'VD
			CONSULTANT		CLIENT	

PC PETROCHEMICAL ENGINEERING CONSULTANTS
C-2, BLOCK NO. 17, GULSHAN-E-IQBAL, NEAR NATIONAL STADIUM, KARACHI-75300, PAKISTAN.
TEL: +92 (21) 34827780, 34961088, FAX: +92 21 34961089, E-Mail: contact@pcec.com.pk web site: www.pcec.com.pk

CLIENT
OIL & GAS DEVELOPMENT COMPANY LTD.

PROJECT
DEVELOPMENT OF BITRISM WEST 1A

TITLE
**TYPICAL DETAIL
KM POSTS & SIGNAL INSTALLATION**

DRAWING NO.	SHEET	REV.
2664-DT-008	NO. OF	C
	1 1	

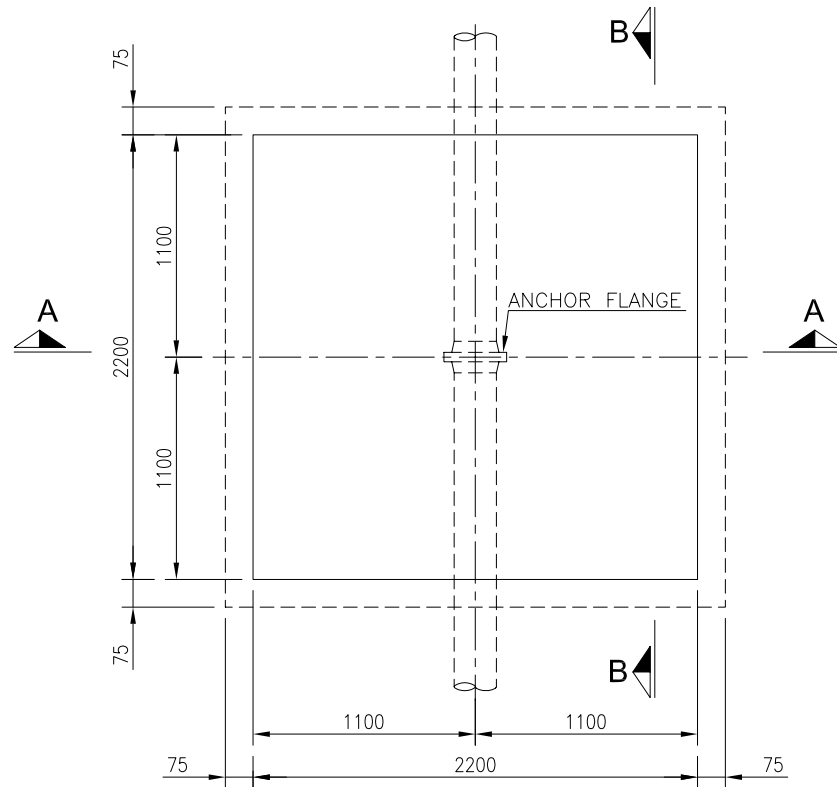

PLAN
(SCALE- 1:30)

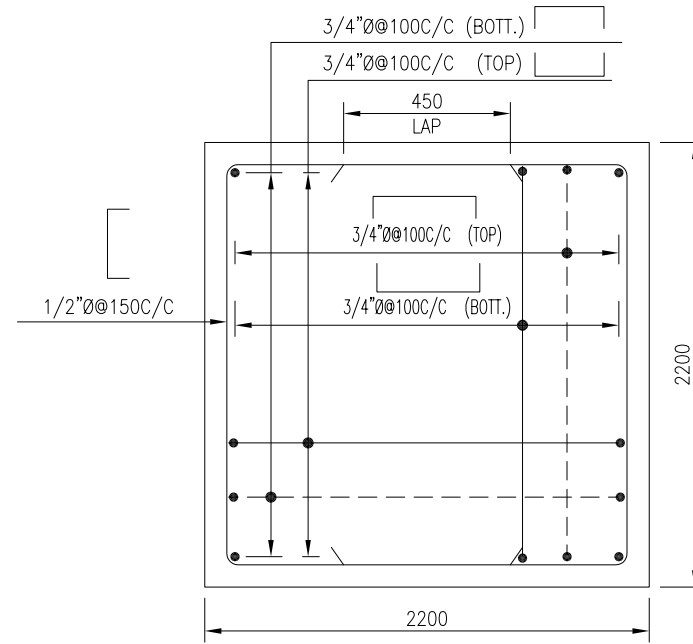

SECTION C-C
(SCALE- 1:30)

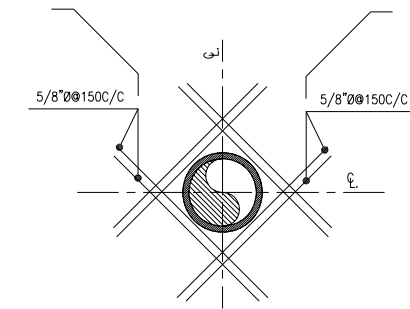

**REINFORCEMENT DETAIL
AROUND PIPE**
(SCALE- 1:30)

**RE-ISSUED FOR
CONSTRUCTION**

NOTES:

1. ALL DIMENSIONS ARE IN mm UNLESS OTHERWISE STATED.
2. 20 GAUGE GALVANIZED WIRE SHALL BE USED FOR BINDING THE STEEL REINFORCEMENT.
3. POTABLE WATER SHALL BE USED FOR MIXING & CURING OF CONCRETE.
4. EXCAVATION BOTTOM TO BE WELL COMPACTED. STARTING OF CONCRETE WORKS SHALL BE ALLOWED AFTER COMPACTION HAS BEEN APPROVED BY OWNER'S REPRESENTATIVE.
5. CONCRETE FOR BLINDING TO BE 1:4:8 AND MIX IN S.R. CEMENT.
6. MINIMUM COVER TO CONCRETE : 75mm FOR FOOTING, 50mm FOR COLUMN & BLOCK.
7. ALL STEEL SHOWN ON THIS DRAWING IS DEFORMED REINFORCING STEEL $f_y=60,000$ psi AS PER ASTM DESIGNATION A-615 GRADE 60.
8. CUTTING PLACING AND OVERLAPPING SHALL BE AS PER A.C.I. 318- LATEST EDITION.
9. STRUCTURAL CONCRETE TO BE 3000 psi. MIX IN SR CEMENT.
10. NO CONCRETE SHALL BE POURED UNTIL STEEL PLACEMENT HAS BEEN APPROVED BY THE ENGINEER/OWNER.

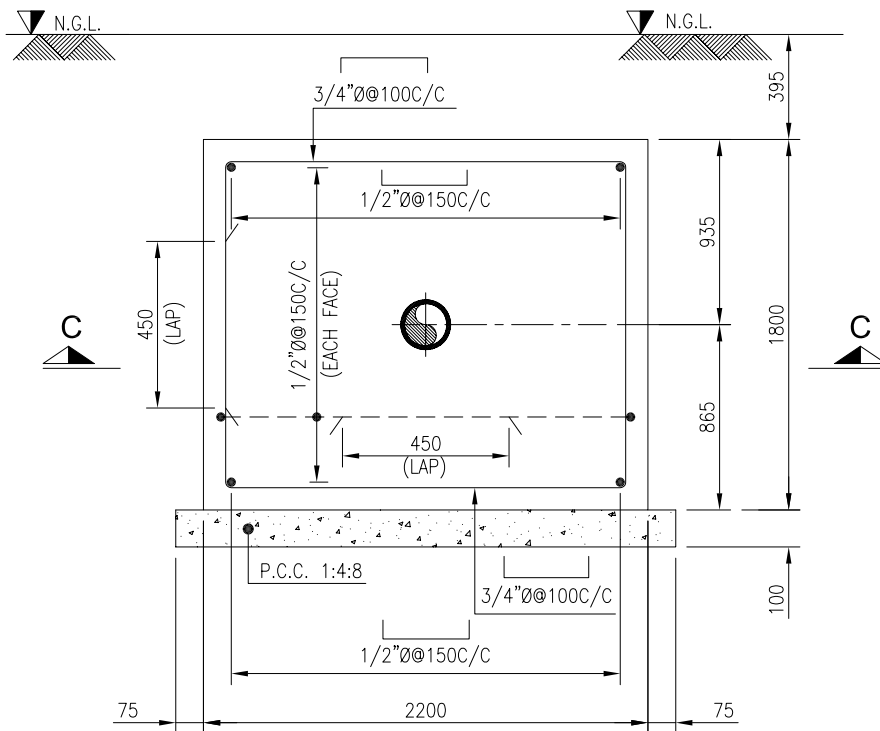

SECTION A-A
(SCALE- 1:30)

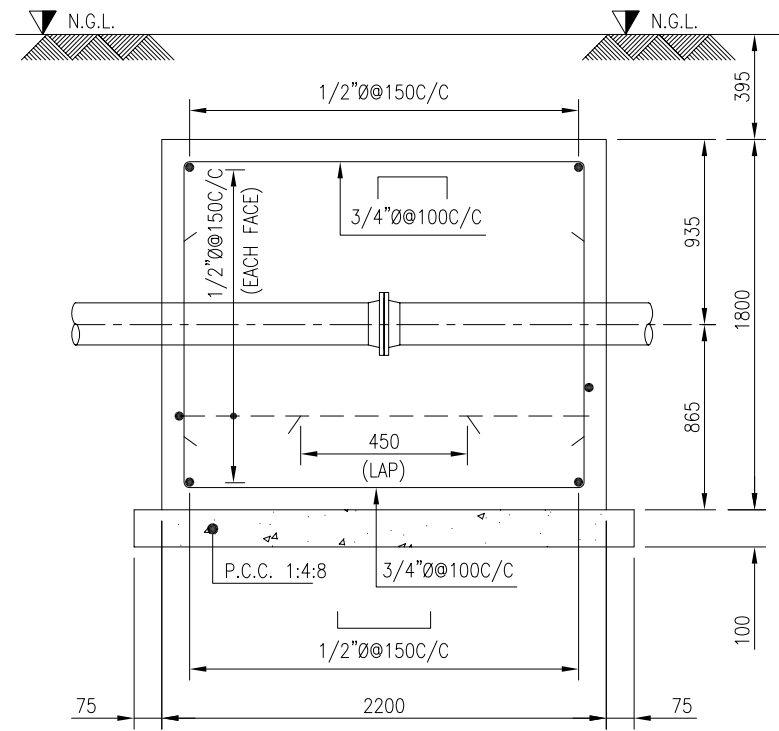

SECTION B-B
(SCALE- 1:30)

B	17-01-17	RE-ISSUED FOR CONSTRUCTION	MU	SAR		
A	08-12-16	ISSUED FOR CONSTRUCTION	MU	SAR		
1	26-11-16	RE-ISSUED FOR REVIEW	AHK	SAR		
0	25-07-16	ISSUED FOR REVIEW	MK	SAR		
REV.	DATE	DESCRIPTION	DRAWN	CHK'D	APP'VD	APP'VD
			CONSULTANT		CLIENT	

PC PETROCHEMICAL ENGINEERING CONSULTANTS
C-2, BLOCK NO. 17, GULSHAN-E-IGBAL, NEAR NATIONAL STADIUM, KARACHI-75300. PAKISTAN
TEL: +92 (21) 34827780, 34961088, FAX: +92 21 34961089, E-Mail: contact@pec.com.pk web site: www.pec.com.pk

CLIENT
OIL & GAS DEVELOPMENT COMPANY LTD.

PROJECT
DEVELOPMENT OF BITRISM WEST 1A

TITLE
ANCHOR BLOCK DETAIL FOR Ø8" PIPELINE

DRAWING NO.		SHEET		REV.
2664-DT-009		NO.	OF	B
		1	1	

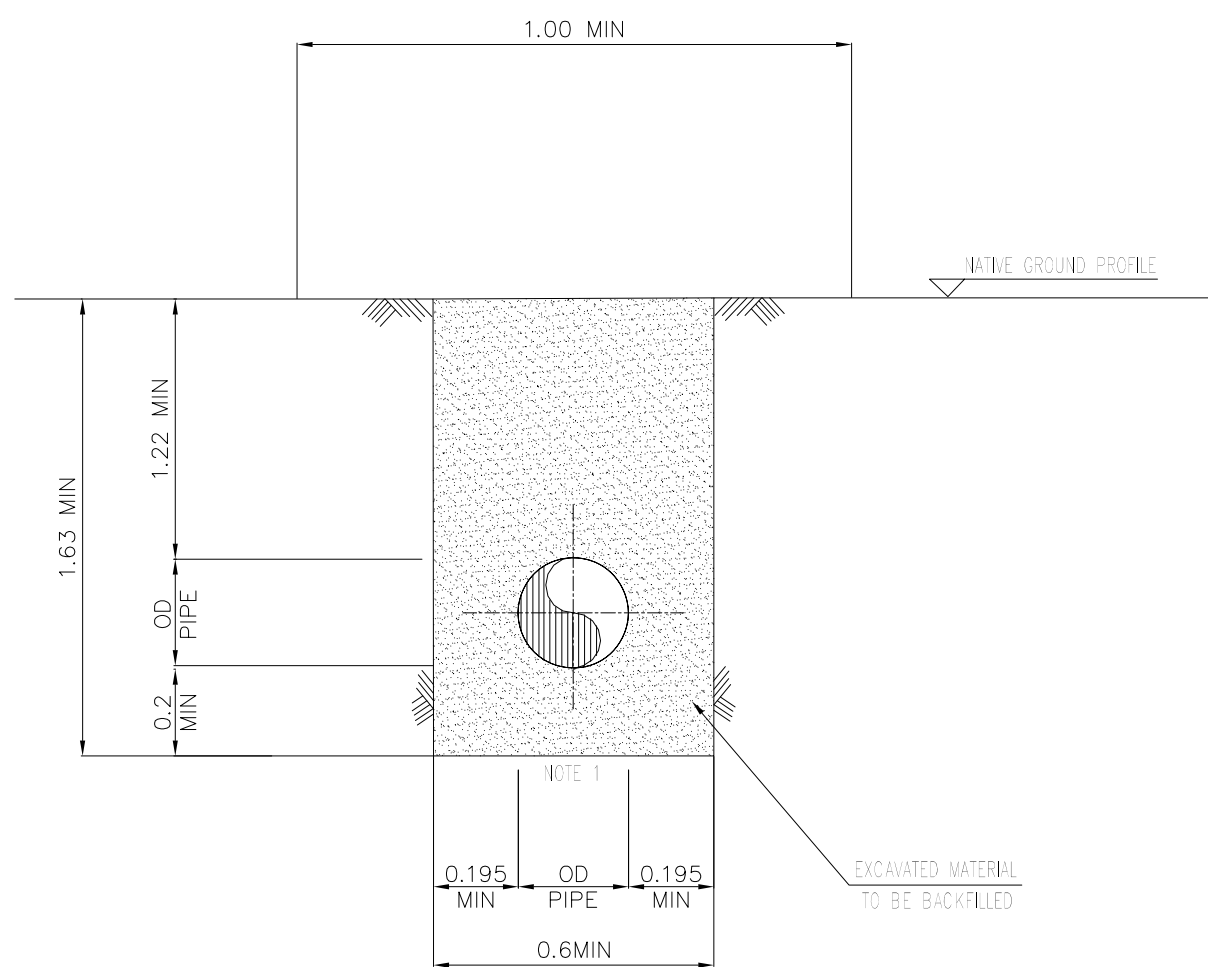

STANDARD DETAIL 8" PIPELINE

- NOTES,
1. BOTTOM OF DITCH SHALL BE UNIFORMLY GRADED & FREE FROM LOOSE ROCKS OR COBBLES/GRAVELS OR OTHER OBJECTS THAT MAY DAMAGE THE PIPE COATING & THE PIPE ITSELF.
 2. THE TRENCH SLOPE VALUE IS TYPICALLY SHOWN THE ACTUAL TRENCH SLOPE VALUE WILL BE DETERMINED FROM LOCAL SITE CONDITIONS & BE ADEQUATE TO MAINTAIN TRENCH WALL STABILITY.
 3. ALL DIMENSIONS ARE IN METERS.

RE-ISSUED FOR CONSTRUCTION

D	11-03-17	RE-ISSUED FOR CONSTRUCTION	MU	SAR		
C	30-01-17	RE-ISSUED FOR CONSTRUCTION	MU	SAR		
B	17-01-17	RE-ISSUED FOR CONSTRUCTION	MU	SAR		
A	08-12-16	ISSUED FOR CONSTRUCTION	MU	SAR		
1	26-11-16	RE-ISSUED FOR REVIEW	AHK	SAR		
0	25-07-16	ISSUED FOR REVIEW	MK	SAR		
REV.	DATE	DESCRIPTION	DRAWN	CHK'D	APP'VD	APP'VD
			CONSULTANT			CLIENT

PC PETROCHEMICAL ENGINEERING CONSULTANTS
 C-2, BLOCK NO. 17, GULSHAN-I-QIBAL, NEAR NATIONAL STADIUM, KARACHI-75300, PAKISTAN
 TEL: +92 (21) 34627790, 34961088, FAX: +92 21 34961083, E-MAIL: contact@pcec.com.pk web site: www.pcec.com.pk

CLIENT
 **OIL & GAS DEVELOPMENT COMPANY LTD.**

PROJECT
DEVELOPMENT OF BITRISM WEST 1A

TITLE
TYPICAL DITCH DIMENSION

DRAWING NO.	SHEET	REV.
2664-DT-010	NO. OF	D
	1 1	

STANDARD R.O.W FOR 8" PIPELINE

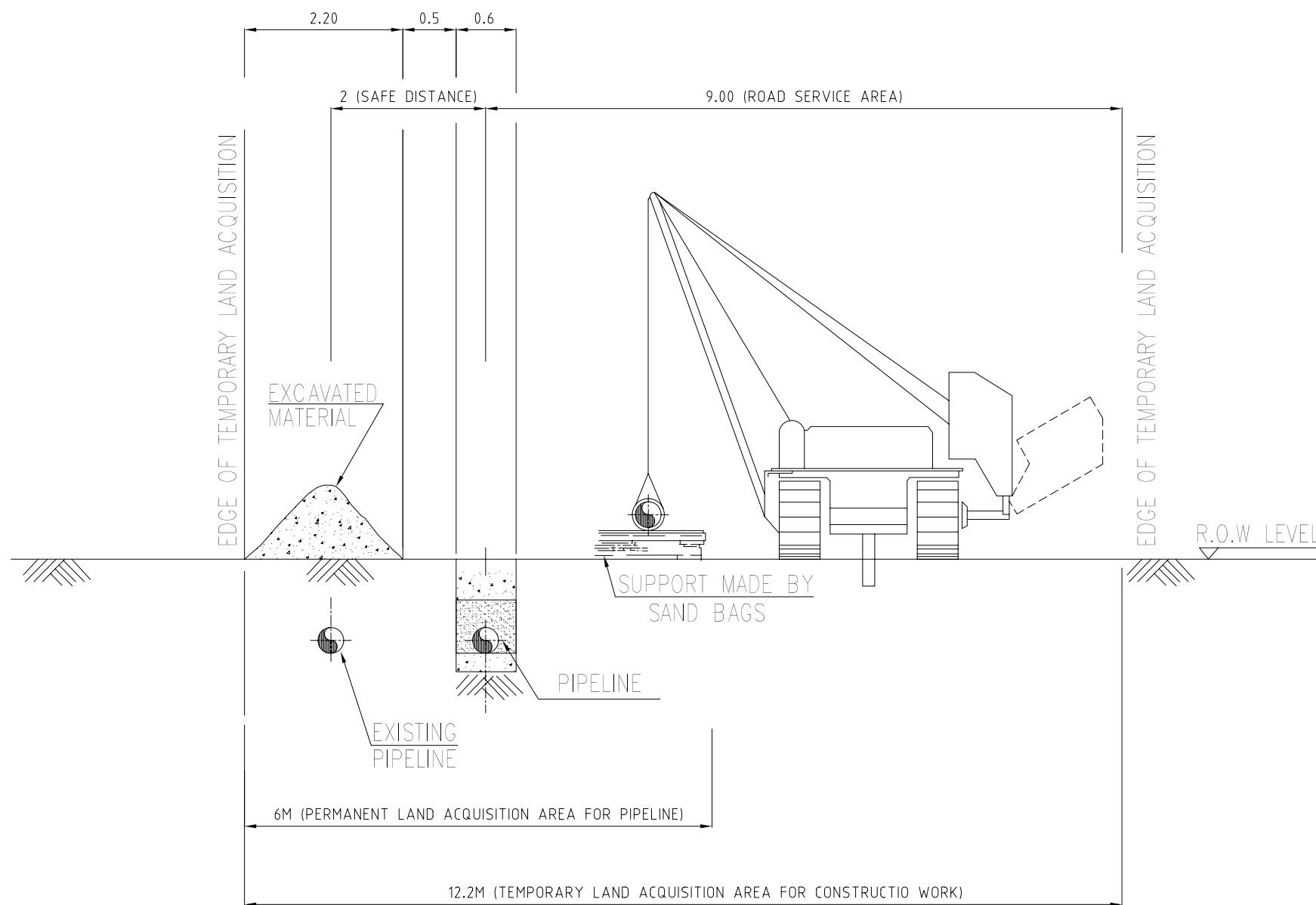

NOTES,

1. ALL DIMENSIONS ARE IN METERS UNLESS OTHERWISE STATED.

RE-ISSUED FOR CONSTRUCTION

REV.	DATE	DESCRIPTION	DRAWN	CHK'D	APP'VD	APP'VD
			CONSULTANT			CLIENT
C	30-01-17	RE-ISSUED FOR CONSTRUCTION	MU	SAR		
B	17-01-17	RE-ISSUED FOR CONSTRUCTION	MU	SAR		
A	08-12-16	ISSUED FOR CONSTRUCTION	MU	SAR		
1	26-11-16	RE-ISSUED FOR REVIEW	AHK	SAR		
0	25-07-16	ISSUED FOR REVIEW	MK	SAR		

PC PETROCHEMICAL ENGINEERING CONSULTANTS
 Plot No. 2, Block No. 17, Gulshan-e-Iqbal, Near National Stadium, Karachi-75300, Pakistan
 TEL: +92 (21) 34827750, 34961088, FAX: +92 21 34961083, E-MAIL: contact@ppec.com.pk web site: www.ppec.com.pk

CLIENT
 OIL & GAS DEVELOPMENT COMPANY LTD.

PROJECT
 DEVELOPMENT OF BITRISM WEST 1A

TITLE
 R.O.W DIMENSIONS FOR PIPELINE

DRAWING NO.	SHEET	REV.
	NO.	OF
2664-DT-011	1	1
		C

HDD SEM NALA CROSSING HDD PROFILE

8 INCH DIA, Sch. 80, CS, API 5L GR.X52.

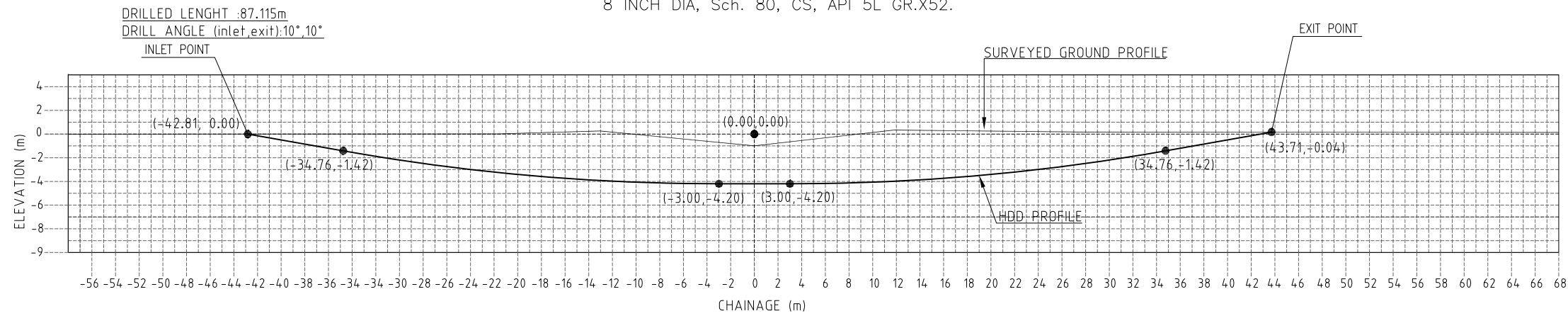

ISSUED FOR
CONSTRUCTION

REFERENCE DRAWINGS

S.NO	DESCRIPTION	DWG. NO
1	FLOWLINE ALIGNMENT DRAWING	2664-PL-042

REV.	DATE	DESCRIPTION	DRAWN	CHK'D	APP'VD	APP'VD
A	26-11-16	ISSUED FOR CONSTRUCTION	AHK	SAR		
			CONSULTANT		CLIENT	

PC PETROCHEMICAL ENGINEERING CONSULTANTS
C-2, BLOCK NO. 17, GULSHAN-E-IQBAL, NEAR NATIONAL STADIUM, KARACHI-75300, PAKISTAN.
TEL: +92 (21) 34827780, 34961088, FAX: +92 21 34961089, E-Mail: contact@pcec.com.pk web site: www.pcec.com.pk

CLIENT
 OIL & GAS DEVELOPMENT COMPANY LTD.

PROJECT
DEVELOPMENT OF BITRISM WEST 1A

TITLE
Ø8" FLOWLINE
HDD SEM NALA CROSSING

DRAWING NO.	SHEET NO.	OF	REV.
2664-DT-012	1	1	A