

**OIL & GAS DEVELOPMENT COMPANY LTD**

**TENDER DOCUMENT**

**FOR**

**FABRICATION, WELDING & INSTALLATION  
OF AG UNIT FROM  
PIRKOH TO LOTI GAS FIELD**

**TENDER ENQUIRY NO:** Proc - SER / CB / CRESS - 4697 / 2020

**Muhammad Muaz**  
C.E (P/Line)  
Ext: 5065



## SUMMARY OF VOLUMES OF TENDER DOCUMENTS

### VOLUME – I

- INTRODUCTION
- INVITATION OF BIDS
- INSTRUCTION TO BIDDERS
- BIDDING DATA
- FORM OF BID AND APPENDICES TO BID
- BILL OF QUANTITIES
- FORMS
- PART – I : GENERAL CONDITIONS OF CONTRACT
- PART – II : PARTICULAR CONDITIONS OF CONTRACT

### VOLUME – II (SCOPE OF WORK)

- Scope Of Work
- Specifications

### VOLUME – III (DRAWINGS)

- Detail Drawings.

FILE: Summary of Tender Docs

  
Muhammad Muaz  
C.E (P/Line)  
Ext: 5065



**VOLUME - I**

**Muhammad Muaz**  
C.E (P/Line)  
Ext: 5065



## CONTENTS

<u>DESCRIPTION</u>	<u>INDEX</u>
INTRODUCTION	1
INVITATION FOR BIDS	2
INSTRUCTION TO BIDDERS	3
BIDDING DATA	4
FORM OF BID AND APPENDICES TO BID INCLUDING BILL OF QUANTITIES	5
FORMS	6
PART – I: GENERAL CONDITIONS OF CONTRACT	7
PART – II: PARTICULAR CONDITIONS OF CONTRACT	8

  
**Muhammad Muaz**  
C.E (P/Line)  
EXT. 6065



# INTRODUCTION

Muhammad Muaz  
S.E. (P/Line)  
Ext: 5005



## INTRODUCTION

Oil & Gas Development Company Limited (OGDCL) is an Exploration / Production company which is operating oil/gas fields in various parts of Islamic Republic of Pakistan. At one of the fields, OGDCL intend to develop PIRKOH & LOTI fields by Dismantling of AG Unit from Pirkoh & Re-welding/Installation at Loti Plant.

Contractor shall procure required construction material, consumable materials as per Scope of Work & BOQ and deploy machinery, equipment, tools and manpower to execute the above mentioned works and hand over the same to OGDCL after testing, commissioning & painting of piping works.

The construction contractor shall prepare their bid as per instructions given in ITB, Bidding Data, and General & Particular Conditions of contract, SOW, BOQ, and Drawing.

OGDCL will provide Pipe of size 16", 10", 8", 6", 4", 3", ¾" at plant Store.

*Details are given in Scope of Work (VOL – II) & BOQ.*

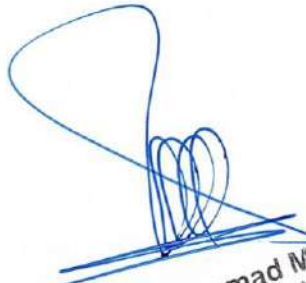

**Muhammad Muaz**  
C.E (P/Line)  
Ext: 5065

**TABLE OF CONTENTS****VOLUME – I**

Sr. No.	Description	SHEET#
<b>INVITATION FOR BIDS</b>		
	Form	2 of 2
<b>INSTRUCTIONS TO BIDDERS</b>		
<b>A. General</b>		
IB.1	Scope of Bid	2 of 14
IB.2	Source of Funds	2 of 14
IB.3	Eligible Bidders	2 of 14
IB.4	One Bid Per Bidder	2 of 14
IB.5	Cost of Bidding	2 of 14
IB.6	Site Visit	2 of 14
<b>B. Bidding Documents</b>		
IB.7	Contents of Bidding Documents	3 of 14
IB.8	Clarification of Bidding Documents	3 of 14
IB.9	Amendment of Bidding Documents	3 of 14
<b>C. Preparation of Bids</b>		
IB.10.	Language of Bid	4 of 14
IB.11	Documents Accompanying the Bid	4 of 14
IB.12	Bid Prices	5 of 14
IB.13	Currencies of Bid and Payment	6 of 14
IB.14	Bid Validity	6 of 14
IB.15	Bid Security	6 of 14
IB.16	Alternate Proposals by Bidder	7 of 14
IB.17	Pre-Bid Meeting	7 of 14
IB.18	Format and Signing of Bid	8 of 14
<b>D. Submission of Bids</b>		
IB.19	Sealing and Marking of Bids	8 of 14
IB.20	Deadline for Submission of Bids	9 of 14
IB.21	Late Bids	10 of 14
IB.22	Modification, Substitution and Withdrawal of Bids	10 of 14
<b>E. Bid Opening and Evaluation</b>		
IB.23	Bid Opening	10 of 14
IB.24	Process to be Confidential	11 of 14

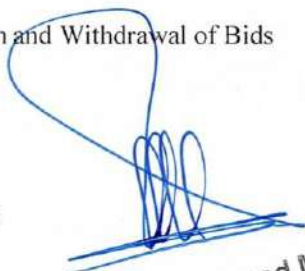
  
**Muhammad Muaz**  
C.E (P/Line)  
Ext: 5065



Sr. No.	Description	SHEET#
IB.25	Clarification of Bids	11 of 14
IB.26	Examination of Bids and Determination of Responsiveness	11 of 14
IB.27	Correction of Errors	11 of 14
IB.28	Evaluation and Comparison of Bids	12 of 14
<b>F. Award of Contract</b>		
IB.29	Award	13 of 14
IB.30	Employer's Right to Accept any Bid and to Reject any or all Bids	13 of 14
IB.31	Notification of Award	13 of 14
IB.32	Performance Security	14 of 14
IB.33	Signing of Contract Agreement	14 of 14
IB.34	General Performance of the Bidders	14 of 14
IB.35	Integrity Pact	
<b>BIDDING DATA</b>		2 of 13
<b>BID AND APPENDICES</b>		
<b>FORM OF BID</b>		2 of 15
Appendix-A to Bid	: Special Stipulations	4 of 15
Appendix-B to Bid	: Foreign Currency Requirements	4 of 15
Appendix-C to Bid	: Price Adjustment (Under Clause 70)	4 of 15
Appendix-D to Bid	: Bill of Quantities	5 of 15
Appendix-E to Bid	: Proposed Construction Schedule	6 of 15
Appendix-F to Bid	: Method of Performing the Work	7 of 15
Appendix-G to Bid	: List of Major Equipment – Related Items	8 of 15
Appendix-H to Bid	: Construction Camp and Housing Facilities	9 of 15
Appendix-I to Bid	: List of Subcontractors	10 of 15
Appendix-J to Bid	: Estimated Progress Payments	11 of 15
Appendix-K to Bid	: Organization Chart of the Supervisory Staff and Labour	12 of 15
Appendix-L to Bid	: List of Bidder Drawings	13 of 15
Appendix-M to Bid	: Integrity Pact	14 of 15
<b>AFFIDAVIT</b>		15 of 15
<b>BOQ</b>		
<b>FORMS</b>		
INDEMNITY BOND		2 of 11
BID BOND		4 of 11
PERFORMANCE SECURITY		5 of 11
CONTRACT AGREEMENT		7 of 11
MOBILIZATION ADVANCE GUARANTEE FORM		10 of 11

Muhammad Muaz  
C.E (P/Line)  
Ext: 5065



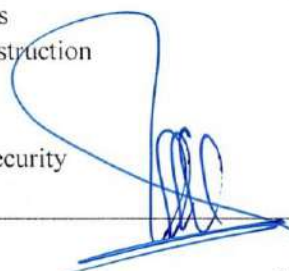

Sr. No.	Description	SHEET#
<b>PART-I: GENERAL CONDITIONS OF CONTRACT</b>		
<b>Definitions and Interpretation</b>		
1.1	Definitions	2 of 60
1.2	Headings and Marginal Notes	4 of 60
1.3	Interpretation	4 of 60
1.4	Singular and Plural	5 of 60
1.5	Notices, Consents, Approvals, Certificates and Determinations	5 of 60
<b>Engineer and Engineer's Representative</b>		
2.1	Engineer's Duties and Authority	5 of 60
2.2	Engineer's Representative	5 of 60
2.3	Engineer's Authority to Delegate	5 of 60
2.4	Appointment of Assistants	6 of 60
2.5	Instructions in Writing	6 of 60
2.6	Engineer to Act Impartially	6 of 60
<b>Assignment and Subcontracting</b>		
3.1	Assignment of Contract	7 of 60
4.1	Subcontracting	7 of 60
4.2	Assignment of Subcontractors' Obligations	7 of 60
<b>Contract Documents</b>		
5.1	Language/s and Law	8 of 60
5.2	Priority of Contract Documents	8 of 60
6.1	Custody and Supply of Drawings and Documents	8 of 60
6.2	One Copy of Drawings to be Kept on Site	9 of 60
6.3	Disruption of Progress	9 of 60
6.4	Delays and Cost of Delay of Drawings	9 of 60
6.5	Failure by Contractor to Submit Drawings	9 of 60
7.1	Supplementary Drawings and Instructions	9 of 60
7.2	Permanent Works Designed by Contractor	10 of 60
7.3	Responsibility Unaffected by Approval	10 of 60
<b>General Obligations</b>		
8.1	Contractor's General Responsibilities	10 of 60
8.2	Site Operations and Methods of Construction	10 of 60
9.1	Contract Agreement	11 of 60
10.1	Performance Security	11 of 60
10.2	Period of Validity of Performance Security	11 of 60
10.3	Claims under Performance Security	11 of 60

  
**Muhammad Muaz**  
C.E (P/Line)  
Ext: 5065



Sr. No.	Description	SHEET#
11.1	Inspection of Site	11 of 60
12.1	Sufficiency of Tender	12 of 60
12.2	Not Foreseeable Physical Obstructions or Conditions	12 of 60
13.1	Work to be in Accordance with Contract	12 of 60
14.1	Programme to be Submitted	13 of 60
14.2	Revised Programme	13 of 60
14.3	Cash Flow Estimate to be Submitted	13 of 60
14.4	Contractor not Relieved of Duties or Responsibilities	13 of 60
15.1	Contractor's Superintendence	13 of 60
16.1	Contractor's Employees	14 of 60
16.2	Engineer at Liberty to Object	14 of 60
17.1	Setting-out	14 of 60
18.1	Boreholes and Exploratory Excavation	15 of 60
19.1	Safety, Security and Protection of the Environment	15 of 60
19.2	Employer's Responsibilities	15 of 60
20.1	Care of Works	15 of 60
20.2	Responsibility to Rectify Loss or Damage	16 of 60
20.3	Loss or Damage Due to Employer's Risks	16 of 60
20.4	Employer's Risks	16 of 60
21.1	Insurance of Works and Contractor's Equipment	17 of 60
21.2	Scope of Cover	17 of 60
21.3	Responsibility for Amounts not Recovered	18 of 60
21.4	Exclusions	18 of 60
22.1	Damage to Persons and Property	18 of 60
22.2	Exceptions	18 of 60
22.3	Indemnity by Employer	19 of 60
23.1	Third Party Insurance (including Employer's Property)	19 of 60
23.2	Minimum Amount of Insurance	19 of 60
23.3	Cross Liabilities	19 of 60
24.1	Accident or Injury to Workmen	19 of 60
24.2	Insurance Against Accident to Workmen	20 of 60
25.1	Evidence and Terms of Insurances	20 of 60
25.2	Adequacy of Insurances	20 of 60
25.3	Remedy on Contractor's Failure to Insure	20 of 60
25.4	Compliance with Policy Conditions	20 of 60
26.1	Compliance with Statutes, Regulations	21 of 60
27.1	Fossils	21 of 60
28.1	Patent Rights	21 of 60
28.2	Royalties	21 of 60
29.1	Interference With Traffic and Adjoining Properties	22 of 60
30.1	Avoidance of Damage to Roads	22 of 60
30.2	Transport of Contractor's Equipment or Temporary Works	22 of 60
30.3	Transport of Materials or Plant	22 of 60
30.4	Waterborne Traffic	23 of 60
31.1	Opportunities for Other Contractors	23 of 60
31.2	Facilities for Other Contractors	23 of 60
32.1	Contractor to Keep Site Clear	24 of 60
33.1	Clearance of Site on Completion	24 of 60

  
**Muhammad Muaz**  
C.E (P/Line)  
Ext: 5065



Sr. No.	Description	SHEET#
<b>Labour</b>		
34.1	Engagement of Staff and Labour	24 of 60
35.1	Returns of Labour and Contractor's Equipment	24 of 60
<b>Materials, Plant and Workmanship</b>		
36.1	Quality of Materials, Plant and Workmanship	24 of 60
36.2	Cost of Samples	25 of 60
36.3	Cost of Tests	25 of 60
36.4	Cost of Tests not Provided for	25 of 60
36.5	Engineer's Determination where Tests not Provided for	25 of 60
37.1	Inspection of Operations	26 of 60
37.2	Inspection and Testing	26 of 60
37.3	Dates for Inspection and Testing	26 of 60
37.4	Rejection	27 of 60
37.5	Independent Inspection	27 of 60
38.1	Examination of Work before Covering up	27 of 60
38.2	Uncovering and Making Openings	27 of 60
39.1	Removal of Improper Work, Materials or Plant	27 of 60
39.2	Default of Contractor in Compliance	28 of 60
<b>Suspension</b>		
40.1	Suspension of Work	28 of 60
40.2	Engineer's Determination following Suspension	28 of 60
40.3	Suspension lasting more than 84 Days	29 of 60
<b>Commencement and Delays</b>		
41.1	Commencement of Works	29 of 60
42.1	Possession of Site and Access Thereto	29 of 60
42.2	Failure to Give Possession	30 of 60
42.3	Rights of Way and Facilities	30 of 60
43.1	Time for Completion	30 of 60
44.1	Extension of Time for Completion	30 of 60
44.2	Contractor to Provide Notification and Detailed Particulars	31 of 60
44.3	Interim Determination of Extension	31 of 60
45.1	Restriction on Working Hours	31 of 60
46.1	Rate of Progress	31 of 60
47.1	Liquidated Damages for Delay	32 of 60
47.2	Reduction of Liquidated Damages	32 of 60
48.1	Taking-Over Certificate	32 of 60
48.2	Taking-Over of Sections or Parts	33 of 60
48.3	Substantial Completion of Parts	33 of 60
48.4	Surfaces Requiring Reinstatement	33 of 60

  
**Muhammad Muaz**  
C.E (P/Line)  
Ext: 5065



Sr. No.	Description	SHEET#
<b>Defects Liability</b>		
49.1	Defects Liability Period	34 of 60
49.2	Completion of Outstanding Work and Remedying Defects	34 of 60
49.3	Cost of Remedying Defects	34 of 60
49.4	Contractor's Failure to Carry Out Instructions	35 of 60
50.1	Contractor to Search	35 of 60
<b>Alterations, Additions and Omissions</b>		
51.1	Variations	35 of 60
51.2	Instructions for Variations	36 of 60
52.1	Valuation of Variations	36 of 60
52.2	Power of Engineer to Fix Rates	36 of 60
52.3	Variations Exceeding 15 percent	37 of 60
52.4	Day work	37 of 60
<b>Procedure for Claims</b>		
53.1	Notice of Claims	38 of 60
53.2	Contemporary Records	38 of 60
53.3	Substantiation of Claims	38 of 60
53.4	Failure to Comply	39 of 60
53.5	Payment of Claims	39 of 60
<b>Contractor's Equipment, Temporary Works and Materials</b>		
54.1	Contractor's Equipment, Temporary Works and Materials; Exclusive Use for the Works.	39 of 60
54.2	Employer not Liable for Damage	39 of 60
54.3	Customs Clearance	39 of 60
54.4	Re-export of Contractor's Equipment	40 of 60
54.5	Conditions of Hire of Contractor's Equipment	40 of 60
54.6	Costs for the Purpose of Clause 63	40 of 60
54.7	Incorporation of Clause in Subcontracts	40 of 60
54.8	Approval of Materials not Implied	40 of 60
<b>Measurement</b>		
55.1	Quantities	41 of 60
56.1	Works to be Measured	41 of 60
57.1	Method of Measurement	41 of 60
57.2	Breakdown of Lump Sum Items	41 of 60
<b>Provisional Sums</b>		
58.1	Definition of "Provisional Sum"	42 of 60
58.2	Use of Provisional Sums	42 of 60
58.3	Production of Vouchers	42 of 60

  
Muhammad Muaz  
C.E (P/Line)  
Ext: 5065



Sr. No.	Description	SHEET#
<b>Nominated Subcontractors</b>		
59.1	Definition of "Nominated Subcontractors"	42 of 60
59.2	Nominated Subcontractors; Objection to Nomination	42 of 60
59.3	Design Requirements to be Expressly Stated	43 of 60
59.4	Payments to Nominated Subcontractors	43 of 60
59.5	Certification of Payments to Nominated Subcontractors	44 of 60
<b>Certificates and Payment</b>		
60.1	Monthly Statements	44 of 60
60.2	Monthly Payments	45 of 60
60.3	Payment of Retention Money	45 of 60
60.4	Correction of Certificates	46 of 60
60.5	Statement at Completion	46 of 60
60.6	Final Statement	47 of 60
60.7	Discharge	47 of 60
60.8	Final Payment Certificate	48 of 60
60.9	Cessation of Employer's Liability	48 of 60
60.10	Time for Payment	48 of 60
61.1	Approval only by Defects Liability Certificate	49 of 60
62.1	Defects Liability Certificate	49 of 60
62.2	Unfulfilled Obligations	49 of 60
<b>Remedies</b>		
63.1	Default of Contractor	49 of 60
63.2	Valuation at Date of Termination	50 of 60
63.3	Payment after Termination	51 of 60
63.4	Assignment of Benefit of Agreement	51 of 60
64.1	Urgent Remedial Work	51 of 60
<b>Special Risks</b>		
65.1	No Liability for Special Risks	52 of 60
65.2	Special Risks	52 of 60
65.3	Damage to Works by Special Risks	52 of 60
65.4	Projectile, Missile	53 of 60
65.5	Increased Costs arising from Special Risks	53 of 60
65.6	Outbreak of War	53 of 60
65.7	Removal of Contractor's Equipment on Termination	53 of 60
65.8	Payment if Contract Terminated	54 of 60
<b>Release from Performance</b>		
66.1	Payment in Event of Release from Performance	55 of 60

  
**Muhammad Muaz**  
C.E (P/Line)  
Ext: 5065



Sr. No.	Description	SHEET#
<b>Settlement of Disputes</b>		
67.1	Engineer's Decision	55 of 60
67.2	Amicable Settlement	56 of 60
67.3	Arbitration	56 of 60
67.4	Failure to Comply with Engineer's Decision	57 of 60
<b>Notices</b>		
68.1	Notice to Contractor	57 of 60
68.2	Notice to Employer and Engineer	57 of 60
68.3	Change of Address	57 of 60
<b>Default of Employer</b>		
69.1	Default of Employer	57 of 60
69.2	Removal of Contractor's Equipment	58 of 60
69.3	Payment on Termination	58 of 60
69.4	Contractor's Entitlement to Suspend Work	58 of 60
69.5	Resumption of Work	59 of 60
<b>Changes in Cost and Legislation</b>		
70.1	Increase or Decrease of Cost	59 of 60
70.2	Subsequent Legislation	59 of 60
<b>Currency and Rates of exchange</b>		
71.1	Currency Restrictions	59 of 60
72.1	Rates of Exchange	60 of 60
72.2	Currency Proportions	60 of 60
72.3	Currencies of Payment for Provisional Sums	60 of 60
<b>PART II - PARTICULAR CONDITIONS OF CONTRACT</b>		
1.1	Definitions	2 of 21
2.1	Engineer's Duties and Authority	2 of 21
2.2	Engineer's Representative	4 of 21
2.7	Engineer Not Liable	4 of 21
2.8	Replacement of the Engineer	4 of 21
5.1	Language(s) and Law	5 of 21
5.2	Priority of Contract Documents	5 of 21
6.6	Shop Drawings	5 of 21
6.7	As-Built Drawings	6 of 21
10.1	Performance Security	6 of 21
10.4	Performance Security Binding on Variations and Changes	6 of 21
14.1	Programme to be Submitted	6 of 21
14.3	Cash Flow Estimate to be Submitted	7 of 21

  
Muhammad Nuaz  
C.E (P/Line)  
Ext: 5065

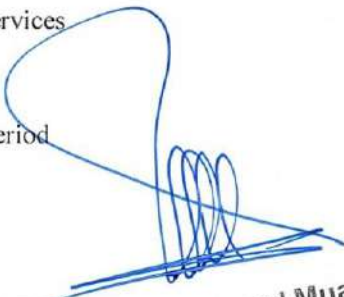

Sr. No.	Description	SHEET#
14.5	Detailed Programme and Monthly Progress Report	7 of 21
15.2	Language Ability of Contractor's Representative	7 of 21
15.3	Contractor's Representative	8 of 21
16.3	Language Ability of Superintending Staff of Contractor	8 of 21
16.4	Employment of Local Personnel	8 of 21
19.3	Safety Precautions	8 of 21
19.4	Lighting Works at Night	9 of 21
20.4	Employer's Risks	9 of 21
21.1	Insurance of Works and Contractor's Equipment	9 of 21
21.3	Responsibility for Amounts not Recovered	9 of 21
21.4	Exclusions	9 of 21
21.5	Taxes	9 of 21
22.2	Exceptions	10 of 21
22.3	Indemnity by the Employer	10 of 21
23.1	Third Party Insurance	10 of 21
25.1	Evidence and Terms of Insurance	11 of 21
25.3	Remedy on Contractor Failure to Insure	11 of 21
25.4	Compliance with Policy Conditions	11 of 21
25.5	Insurance Company	11 of 21
31.3	Co-operation with Other Contractors	11 of 21
34.2	Rates of Wages and Conditions of Labour	12 of 21
34.3	Employment of Persons in the Service of Others	12 of 21
34.4	Housing for Labour	12 of 21
34.5	Health and Safety	12 of 21
34.6	Epidemics	12 of 21
34.7	Supply of Water	13 of 21
34.8	Alcoholic Liquor or Drugs	13 of 21
34.9	Arms and Ammunition	13 of 21
34.10	Festivals and Religious Customs	13 of 21
34.11	Disorderly Conduct	13 of 21
34.12	Compliance by Subcontractors	13 of 21
35.2	Records of Safety and Health	13 of 21
35.3	Reporting of Accidents	14 of 21
36.6	Use of Pakistani Materials and Services	14 of 21
41.1	Commencement of Works	14 of 21
48.2	Taking Over of Sections or Parts	14 of 21
49.5	Extensions of Defects Liability Period	14 of 21
51.2	Instructions for Variations	15 of 21
52.1	Valuation of Variations	15 of 21
53.4	Failure to Comply	15 of 21
54.3	Customs Clearance	15 of 21
54.5	Conditions of Hire of Contractor's Equipment	15 of 21
59.4	Payments to Nominated Sub-contractors	15 of 21
59.5	Evidence of Payments	15 of 21
60.1	Monthly Statements	16 of 21
60.2	Monthly Payments	16 of 21
60.11	Secured Advance on Materials	16 of 21

  
**Muhammad Muaz**  
C.E (P/Line)  
Ext: 5065



Sr. No.	Description	SHEET#
60.12	Financial Assistance to Contractor	17 of 21
63.1	Default of Contractor	18 of 21
65.2	Special Risks	18 of 21
67.3	Arbitration	18 of 21
68.1	Notice to Contractor	18 of 21
68.2	Notice to Employer and Engineer	19 of 21
70.1	Increase or Decrease of Cost	19 of 21
73.1	Payment of Income Tax	19 of 21
73.2	Customs Duty & Taxes	19 of 21
74.1	Integrity Pact	19 of 21
75.1	Termination of Contract for Employer's Convenience	20 of 21
76.1	Liability of Contractor	20 of 21
77.1	Joint and Several Liability	20 of 21
78.1	Details to be Confidential	20 of 21

**VOLUME – II**

Scope of Work
Specifications

**VOLUME – III**

DRAWINGS
----------

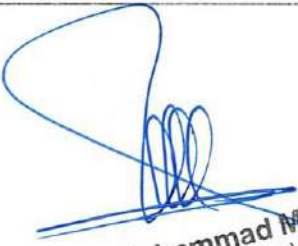

**Muhammad Muaz**  
C.E (P/Line)  
Ext: 5065





**INVITATION FOR BIDS**

**Muhammad Muaz**  
C.E (P/Line)  
Ext: 5065



**INVITATION FOR BIDS**

Date: \_\_\_\_\_

Bid Reference No.: \_\_\_\_\_

1. The Oil & Gas Development Company Limited (OGDCL) Islamabad the (“Employer”) intends to develop NASHPA plant under the contract for *“Fabrication, Welding and Installation of AG Unit from Pirkoh to Loti Gas Field”*. Bidding is open for all eligible bidders.
2. The Employer invites sealed bids under **Single Stage – One Envelope** bidding procedure, from eligible firms or persons licensed by the Pakistan Engineering Council in the appropriate category for the works & field of Specialization. A foreign bidder is entitled to bid only in a joint venture with a Pakistani constructor in accordance with the relevant provisions of PEC bye-laws.
3. Bidders may obtain further information from, inspect at and acquire the Bidding Documents downloaded from OGDCL web site [www.ogdcl.com](http://www.ogdcl.com) under the title bar to tenders.
4. All bids must be accompanied by a Bid Security in the form of a Bank Draft/ Pay Order/ Deposit at Call / CDR / Bank Guarantee payable at any scheduled Bank in Islamabad for an amount of **PKR 0.5 Million** to be submitted original with Technical Bid & must be delivered in the office of “The General Manager (SCM) on behalf of *“Oil & Gas Development Company Limited (OGDCL), Islamabad”*.
5. Bids will be opened as per press advertisement in the presence of bidder’s representatives who choose to attend at the same address.

  
Muhammad Muaz  
C.E (P/Line)  
Ext: 5065



# INSTRUCTIONS TO BIDDERS

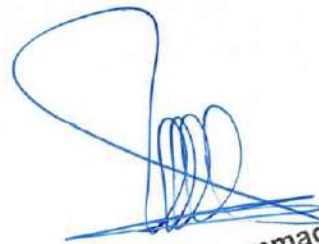

**Muhammad Muaz**  
C.E (P/Line)  
Ext: 5065



## INSTRUCTIONS TO BIDDERS

### A. GENERAL

#### IB.1 Scope of Bid

- 1.1 The Employer as defined in the Bidding Data hereinafter called "the Employer" wishes to receive bids for the construction and completion of works as described in these Bidding Documents, and summarized in the Bidding Data hereinafter referred to as the "Works".
- 1.2 The successful bidder will be expected to complete the Works within the time specified in Appendix-A to Bid.

#### IB.2 Source of Funds

- 2.1 The Employer has applied for/received a loan/credit from the source (s) indicated in the Bidding Data in various currencies towards the cost of the project specified in the Bidding Data and it is intended that part of the proceeds of this loan/credit will be applied to eligible payments under the Contract for which these Bidding Documents are issued.

#### IB.3 Eligible Bidders

- 3.1 This Invitation for Bids is open to all bidders meeting the following requirements:
  - a. Duly licensed by the Pakistan Engineering Council (PEC) in the category relevant to the value of the Works.
  - b. Duly pre-qualified / enlisted with the Employer.

#### IB.4 One Bid per Bidder

- 4.1 Each bidder shall submit only one bid either by himself, or as a partner in a joint venture. A bidder who submits or participates in more than one bid (other than alternatives pursuant to Clause IB.16) will be disqualified.

#### IB.5 Cost of Bidding

- 5.1 The bidders shall bear all costs associated with the preparation and submission of their respective bids and the Employer will in no case be responsible or liable for those costs, regardless of the conduct or outcome of the bidding process.

#### IB.6 Site Visit

- 6.1 The bidders are advised to visit and examine the Site of Works and its surroundings and obtain for themselves on their own responsibility all information that may be necessary for preparing the bid and entering into a contract for construction of the Works. All cost in this respect shall be at the bidder's own expense.
- 6.2 The bidders and any of their personnel or agents will be granted permission by the Employer to enter upon his premises and lands for the purpose of such inspection, but



only upon the express condition that the bidders, their personnel and agents, will release and indemnify the Employer, his personnel and agents from and against all liability in respect thereof and will be responsible for death or personal injury, loss of or damage to property and any other loss, damage, costs and expenses incurred as a result of such inspection.

## **B. BIDDING DOCUMENTS**

### **IB.7 Contents of Bidding Documents**

7.1 The Bidding Documents, in addition to invitation for bids, are those stated below and should be read in conjunction with any Addenda issued in accordance with Clause IB.9.

1. Instructions to Bidders.
2. Bidding Data.
3. General Conditions of Contract, Part-I (GCC).
4. Particular Conditions of Contract, Part-II (PCC).
5. Specifications - Technical Provisions.
6. Form of Bid & Appendices to Bid.
7. Bill of Quantities (Appendix-D to Bid).
8. Form of Bid Security.
9. Form of Contract Agreement.
10. Forms of Performance Security and Mobilization Advance Guarantee/Bond.
11. Drawings.

7.2 The bidders are expected to examine carefully the contents of all the above documents. Failure to comply with the requirements of bid submission will be at the Bidder's own risk. Pursuant to Clause IB.26, bids which are not substantially responsive to the requirements of the Bidding Documents will be rejected.

### **IB.8 Clarification of Bidding Documents**

8.1 Any prospective bidder requiring any clarification (s) in respect of the Bidding Documents may notify the Employer in writing at the Employer's address indicated in the Invitation for Bids. The Employer will respond to any request for clarification which he receives earlier than 28 days prior to the deadline for submission of bids.

Copies of the Employer's response will be forwarded to all purchasers of the Bidding Documents, including a description of the enquiry but without identifying its source.

### **IB.9 Amendment of Bidding Documents**

9.1 At any time prior to the deadline for submission of bids, the Employer may, for any reason, whether at his own initiative or in response to a clarification requested by a prospective bidder, modify the Bidding Documents by issuing addendum.

9.2 Any addendum thus issued shall be part of the Bidding Documents pursuant to Sub-Clause 7.1 hereof and shall be communicated in writing to all purchasers of the Bidding Documents. Prospective bidders shall acknowledge receipt of each addendum



in writing to the Employer.

- 9.3 To afford prospective bidders reasonable time in which to take an addendum into account in preparing their bids, the Employer may extend the deadline for submission of bids in accordance with Clause IB.20
- 9.4 "Any other clarification given by the employer in writing to the bidders at pre-bid stage shall be considered as an addendum and shall be part of the bid documents."

### C. PREPARATION OF BIDS

#### IB.10 Language of Bid

- 10.1 The bid and all correspondence and documents related to the bid exchanged by a bidder and the Employer shall be in the bid language stipulated in the Bidding Data and Particular Conditions of Contract. Supporting documents and printed literature furnished by the bidders may be in any other language provided the same are accompanied by an accurate translation of the relevant parts in the bid language, in which case, for purposes of evaluation of the bid, the translation in bid language shall prevail.

#### IB.11 Documents Accompanying the Bid

11.1 Each bidder shall:

- (a) Submit a written power of attorney authorizing the signatory of the bid to act for and on behalf of the bidder;
- (b) Update the information indicated and listed in the Bidding Data and previously submitted with the application for prequalification, and continue to meet the minimum criteria set out in the prequalification documents which as a minimum, would include the following :
- (i) Evidence of access to financial resources along with average annual construction turnover;
  - (ii) Financial predictions for the current year and the two following years including the effect of known commitments;
  - (iii) Work commitments since prequalification;
  - (iv) Current litigation information.
  - (v) Availability of critical equipment.
- (c) Furnish a technical proposal taking into account the various Appendices to Bid specially the following:

Appendix-E to Bid	Proposed Construction Schedule
Appendix-F to Bid	Method of Performing the Work
Appendix-G to Bid	List of Major Equipment
Appendix-K to Bid	Organization Chart for Supervisory Staff
and other pertinent information such as mobilization programme etc;	



11.2 Bids submitted by a joint venture of two (2) or more firms shall comply with the following requirements:

- (a) The bid and in case of a successful bid, the Form of Contract Agreement shall be signed so as to be legally binding on all partners;
- (b) One of the joint venture partners shall be nominated as being in charge; and this Authorization shall be evidenced by submitting a power of attorney signed by legally authorized signatories of all the joint venture partners;
- (c) The partner-in-charge shall always be duly authorized to deal with the Employer regarding all matters related with and/or incidental to the execution of Works as per the terms and Conditions of Contract and in this regard to incur any and all liabilities, receive instructions, give binding undertakings and receive payments on behalf of the joint venture;
- (d) All partners of the joint venture shall at all times and under all circumstances be liable jointly and severally for the execution of the Contract in accordance with the Contract terms and a statement to this effect shall be included in the authorization mentioned under Sub-Para(b) above as well as in the Form of Bid and in the Form of Contract Agreement (in case of a successful bid); and
- (e) A copy of the agreement entered into by the joint venture partners shall be submitted with the bid stating the conditions under which it will function, its period of duration, the persons authorized to represent and obligate it and which persons will be directly responsible for due performance of the Contract and can give valid receipts on behalf of the joint venture, the proportionate participation of the several firms forming the joint venture, and any other information necessary to permit a full appraisal of its functioning. No amendments / modifications whatsoever in the joint venture agreement shall be agreed to between the joint venture partners without prior written consent of the Employer.

11.3 Bidders shall also submit proposals of work methods and schedule, in sufficient detail to demonstrate the adequacy of the Bidders' proposals to meet the technical specifications and the completion time referred to in Sub-Clause 1.2 hereof.

**IB.12 Bid Prices**

12.1 Unless stated otherwise in the Bidding Documents, the Contract shall be for the whole of the Works as described in Sub-Clause 1.1 hereof, based on the unit rates and / or prices submitted by the bidder.

12.2 The bidders shall fill in rates and prices for all items of the Works described in the Bill of Quantities. Items against which no rate or price is entered by a bidder will not be paid for by the Employer when executed and shall be deemed covered by rates and prices for other items in the Bill of Quantities.

12.3 All duties, taxes and other levies payable by the Contractor under the Contract, or for any other cause, as on the date 28 days prior to the deadline for submission of bids shall be included in the rates and prices and the total Bid Price submitted by a bidder.

Additional / reduced duties, taxes and levies due to subsequent additions or changes in

**Muhammad Muaz**  
C.E (P/Line)  
Ext: 5065



Demand Draft or Deposit at Call or CDR or Bank Guarantee issued by a scheduled Bank in favour of Oil & Gas Development Company Limited, Islamabad payable at Islamabad valid for a period 28 days beyond the Bid Validity date.

- 15.3 Any bid not accompanied by an acceptable Bid Security shall be rejected by the Employer as non-responsive.
- 15.4 The bid securities of unsuccessful bidders will be returned as promptly as possible, but not later than 28 days after the expiration of the period of Bid Validity.
- 15.5 The Bid Security of the successful bidder will be returned when the bidder has furnished the required Performance Security and signed the Contract Agreement.
- 15.6 The Bid Security may be forfeited:
- (a) If the bidder withdraws his bid except as provided in Sub-Clause 22.1;
  - (b) If the bidder does not accept the correction of his Bid Price pursuant to Sub-Clause 27.2 hereof; or
  - (c) In the case of successful bidder, if he fails within the specified time limit to:
    - (i) Furnish the required Performance Security; or
    - (ii) Sign the Contract Agreement.

#### **IB.16 Alternate Proposals by Bidder**

- 16.1 Should any bidder consider that he can offer any advantages to the Employer by a modification to the designs, specifications or other conditions, he may, in addition to his bid to be submitted in strict compliance with the Bidding Documents, submit any Alternate Proposal(s) containing (a) relevant design calculations; (b) technical specifications; (c) proposed construction methodology; and (d) any other relevant details / conditions, provided always that the total sum entered on the Form of Bid shall be that which represents complete compliance with the Bidding Documents.
- 16.2 Alternate Proposal(s), if any, of the lowest evaluated responsive bidder only may be considered by the Employer as the basis for the award of Contract to such bidder.

#### **IB.17 Pre-Bid Meeting**

- 17.1 The Employer may, on his own motion or at the request of any prospective bidder(s), hold a pre-bid meeting to clarify issues and to answer any questions on matters related to the Bidding Documents. The date, time and venue of pre-bid meeting, if convened, is as stipulated in the Bidding Data. All prospective bidders or their authorized representatives shall be invited to attend such a pre-bid meeting.
- 17.2 The bidders are requested to submit questions, if any, in writing so as to reach the Employer not later than seven (7) days before the proposed pre-bid meeting.
- 17.3 Minutes of the pre-bid meeting, including the text of the questions raised and the replies





given, will be transmitted without delay to all purchasers of the Bidding Documents. Any modification of the Bidding Documents listed in Sub-Clause 7.1 hereof which may become necessary as a result of the pre-bid meeting shall be made by the Employer exclusively through the issue of an Addendum pursuant to Clause IB.9 and not through the minutes of the pre-bid meeting.

17.4 Absence at the pre-bid meeting will not be a cause for disqualification of a bidder.

**IB.18 Format and Signing of Bid**

18.1 Bidders are particularly directed that the amount entered on the Form of Bid shall be for performing the Contract strictly in accordance with the Bidding Documents.

18.2 All appendices to Bid are to be properly completed and signed.

18.3 No alteration is to be made in the Form of Bid nor in the Appendices thereto except in filling up the blanks as directed. If any such alterations be made or if these instructions be not fully complied with, the bid may be rejected.

18.4 Each bidder shall prepare by filling out the forms completely and without alterations one (1) original and number of copies, specified in the Bidding Data, of the documents comprising the bid as described in Clause IB.7 and clearly mark them "ORIGINAL" and "COPY" as appropriate. In the event of discrepancy between them, the original shall prevail.

18.5 The original and all copies of the bid shall be typed or written in indelible ink (in the case of copies, Photostats are also acceptable) and shall be signed by a person or persons duly authorized to sign on behalf of the bidder pursuant to Sub- Clause 11.1(a) hereof. All pages of the bid shall be initialed and stamped by the person or persons signing the bid.

18.6 The bid shall contain no alterations, omissions or additions, except to comply with instructions issued by the Employer, or as are necessary to correct errors made by the bidder, in which case such corrections shall be initialed by the person or persons signing the bid.

18.7 Bidders shall indicate in the space provided in the Form of Bid their full and proper addresses at which notices may be legally served on them and to which all correspondence in connection with their bids and the Contract is to be sent.

18.8 Bidders should retain a copy of the Bidding Documents as their file copy.

**D. SUBMISSION OF BIDS**

**IB.19 Sealing and Marking of Bids**

19.1 Each bidder shall submit his bid as under:

- (a) ORIGINAL and each copy of the Bid shall be separately sealed and put in separate envelopes and marked as such.



- (b) The envelopes containing the ORIGINAL and copies will be put in one sealed envelope and addressed / identified as given in Sub- Clause 19.2 hereof.

19.2 The inner and outer envelopes shall

- (a) Be addressed to the Employer at the address provided in the Bidding Data;
- (b) Bear the name and identification number of the contract as defined in the Bidding Data; and
- (c) Provide a warning not to open before the time and date for bid opening, as specified in the Bidding Data.

19.3 In addition to the identification required in Sub- Clause 19.2 hereof, the inner envelope shall indicate the name and address of the bidder to enable the bid to be returned unopened in case it is declared "late" pursuant to Clause IB.21

19.4 If the outer envelope is not sealed and marked as above, the Employer will assume no responsibility for the misplacement or premature opening of the Bid.

**IB.20 Deadline for Submission of Bids**

- 20.1 (a) Bids must be received by the Employer at the address specified no later than the time and date stipulated in the Bidding Data.
- (b) Bids with charges payable will not be accepted, nor will arrangements be undertaken to collect the bids from any delivery point other than that specified above. Bidders shall bear all expenses incurred in the preparation and delivery of bids. No claims will be entertained for refund of such expenses.
- (c) Where delivery of a bid is by mail and the bidder wishes to receive an acknowledgment of receipt of such bid, he shall make a request for such acknowledgment in a separate letter attached to but not included in the sealed bid package.
- (d) Upon request, acknowledgment of receipt of bids will be provided to those making delivery in person or by messenger.

20.2 The Employer may, at his discretion, extend the deadline for submission of bids by issuing an amendment in accordance with Clause IB.9, in which case all rights and obligations of the Employer and the bidders previously subject to the original deadline will thereafter be subject to the deadline as extended.



Muhammad Muaz  
C.E (P/Line)  
Ext: 5065

**IB.21 Late Bids**

- 21.1(a) Any bid received by the Employer after the deadline for submission of bids prescribed in Clause IB.20 will be returned unopened to such bidder.
- (b) Delays in the mail, delays of person in transit, or delivery of a bid to the wrong office shall not be accepted as an excuse for failure to deliver a bid at the proper place and time. It shall be the bidder's responsibility to determine the manner in which timely delivery of his bid will be accomplished either in person, by messenger or by mail.

**IB.22 Modification, Substitution and Withdrawal of Bids**

- 22.1 Any bidder may modify, substitute or withdraw his bid after bid submission provided that the modification, substitution or written notice of withdrawal is received by the Employer prior to the deadline for submission of bids.
- 22.2 The modification, substitution, or notice for withdrawal of any bid shall be prepared, sealed, marked and delivered in accordance with the provisions of Clause IB.19 with the outer and inner envelopes additionally marked "MODIFICATION", "SUBSTITUTION" or "WITHDRAWAL" as appropriate.
- 22.3 No bid may be modified by a bidder after the deadline for submission of bids except in accordance with Sub-Clauses 22.1 and 27.2.
- 22.4 Withdrawal of a bid during the interval between the deadline for submission of bids and the expiration of the period of bid validity specified in the Form of Bid may result in forfeiture of the Bid Security in pursuance to Clause IB.15.

**E. BID OPENING AND EVALUATION****IB.23 Bid Opening**

- 23.1 The Employer will open the bids, including withdrawals, substitution and modifications made pursuant to Clause IB.22, in the presence of bidders' representatives who choose to attend, at the time, date and location stipulated in the Bidding Data. The bidders' representatives who are present shall sign a register evidencing their attendance.
- 23.2 Envelopes marked "MODIFICATION", "SUBSTITUTION" or "WITHDRAWAL" shall be opened and read out first. Bids for which an acceptable notice of withdrawal has been submitted pursuant to Clause IB.22 shall not be opened.
- 23.3 The bidder's name, total Bid Price and price of any Alternate Proposal(s), any discounts, bid modifications, substitution and withdrawals, the presence or absence of Bid Security, and such other details as the Employer may consider appropriate, will be announced by the Employer at the opening of bids.
- 23.4 Employer shall prepare minutes of the bid opening, including the information disclosed to those present in accordance with the Sub-Clause 23.3.

**IB.24 Process to be Confidential**

- 24.1 Information relating to the examination, clarification, evaluation and comparison of bid and recommendations for the award of a contract shall not be disclosed to bidders or any other person not officially concerned with such process before the announcement of bid evaluation report which shall be done at least ten (10) days prior to issue of Letter of Acceptance. The announcement to all

Bidders will include table(s) comprising read out prices, discounted prices, price adjustments made, final evaluated prices and recommendations against all the bids evaluated. Any effort by a bidder to influence the Employer's processing of bids or award decisions may result in the rejection of such bidder's bid. Whereas any bidder feeling aggrieved may lodge a written complaint not later than fifteen (15) days after the announcement of the bid evaluation report; however mere fact of lodging a complaint shall not warrant suspension of the procurement process.

**IB.25 Clarification of Bids**

- 25.1 To assist in the examination, evaluation and comparison of bids, the Employer may, at his discretion, ask any bidder for clarification of his bid, including breakdowns of unit rates. The request for clarification and the response shall be in writing but no change in the price or substance of the bid shall be sought, offered or permitted except as required to confirm the correction of arithmetic errors discovered by the Employer in the evaluation of the bids in accordance with Clause IB.28.

**IB.26 Examination of Bids and Determination of Responsiveness**

- 26.1 Prior to the detailed evaluation of bids, the Employer will determine whether each bid is substantially responsive to the requirements of the Bidding Documents.
- 26.2 A substantially responsive bid is one which (i) meets the eligibility criteria; (ii) has been properly signed; (iii) is accompanied by the required Bid Security; and (iv) conforms to all the terms, conditions and specifications of the Bidding Documents, without material deviation or reservation. A material deviation or reservation is one (i) which affect in any substantial way the scope, quality or performance of the Works; (ii) which limits in any substantial way, inconsistent with the Bidding Documents, the Employer's rights or the bidder's obligations under the Contract; or (iii) adoption/rectification whereof would affect unfairly the competitive position of other bidders presenting substantially responsive bids.
- 26.3 If a bid is not substantially responsive, it will be rejected by the Employer, and may not subsequently be made responsive by correction or withdrawal of the non-conforming deviation or reservation.

**IB.27 Correction of Errors**

- 27.1 Bids determined to be substantially responsive will be checked by the Employer for any arithmetic errors. Errors will be corrected by the Employer as follows:



- (a) Where there is a discrepancy between the amounts in figures and in words, the amount in words will govern; and
- (b) where there is a discrepancy between the unit rate and the line item total resulting from multiplying the unit rate by the quantity, the unit rate as quoted will govern, unless in the opinion of the Employer there is an obviously gross misplacement of the decimal point in the unit rate, in which case the line item total as quoted will govern and the unit rate will be corrected.

27.2 The amount stated in the Form of Bid will be adjusted by the Employer in accordance with the above procedure for the correction of errors and with the concurrence of the bidder, shall be considered as binding upon the bidder. If the bidder does not accept the corrected Bid Price, his Bid will be rejected, and the Bid Security shall be forfeited in accordance with Sub- Clause 15.6(b) hereof.

#### **IB.28 Evaluation and Comparison of Bids**

28.1 The Employer will evaluate and compare only the Bids determined to be substantially responsive in accordance with Clause IB.26.

28.2 In evaluating the Bids, the Employer will determine for each Bid the evaluated Bid Price by adjusting the Bid Price as follows:

- (a) making any correction for errors pursuant to Clause IB.27;
- (b) excluding Provisional Sums and the provision, if any, for contingencies in the Summary Bill of Quantities, but including competitively priced Day work; and
- (c) making an appropriate adjustment for any other acceptable variation or deviation.

28.3 The estimated effect of the price adjustment provisions of the Conditions of Contract, applied over the period of execution of the Contract, shall not be taken into account in Bid evaluation.

28.4 If the Bid of the successful bidder is seriously unbalanced in relation to the Employer's estimate of the cost of work to be performed under the Contract, the Employer may require the bidder to produce detailed price analyses for any or all items of the Bill of Quantities to demonstrate the internal consistency of those prices with the construction methods and schedule proposed. After evaluation of the price analyses, the Employer may require that the amount of the Performance Security set forth in Clause IB.32 be increased at the expense of the successful bidder to a level sufficient to protect the Employer against financial loss in the event of default of the successful bidder under the Contract.



**F. AWARD OF CONTRACT**

**IB.29 Award**

- 29.1 Subject to Clauses IB.30 and IB.34, the Employer will award the Contract to the bidder whose bid has been determined to be substantially responsive to the Bidding Documents and who has offered the lowest evaluated Bid Price, provided that such bidder has been determined to be eligible in accordance with the provisions of Clause IB.3 and qualify pursuant to Sub-Clause IB 29.2.
- 29.2 The Employer, at any stage of the bid evaluation, having credible reasons for or prima facie evidence of any defect in supplier's or contractor's capacities, may require the suppliers or contractors to provide information concerning their professional, technical, financial, legal or managerial competence whether already pre-qualified or not:

Provided that such qualification shall only be laid down after recording reasons therefore in writing. They shall form part of the records of that bid evaluation report.

Mandatory requirements and Technical Evaluation criteria is attached in bidding data, which shall be filled by employer. Accordingly contractor's technical evaluation shall be carried out.

**IB.30 Employer's Right to Accept any Bid and to Reject any or all Bids**

- 30.1 Notwithstanding Clause IB.29, the Employer reserves the right to accept or reject any Bid, and to annul the bidding process and reject all bids, at any time prior to award of Contract, without thereby incurring any liability to the affected bidders or any obligation except that the grounds for rejection of all bids shall upon request be communicated to any bidder who submitted a bid, without justification of grounds. Rejection of all bids shall be notified to all bidders promptly.

**IB.31 Notification of Award**

- 31.1 Prior to expiration of the period of bid validity prescribed by the Employer, the Employer will notify the successful bidder in writing ("Letter of Acceptance") that his Bid has been accepted. This letter shall name the sum which the Employer will pay the Contractor in consideration of the execution and completion of the Works by the Contractor as prescribed by the Contract (hereinafter and in the Conditions of Contract called the "Contract Price").
- 31.2 No Negotiation with the bidder having evaluated as lowest responsive or any other bidder shall be permitted, however, Employer may have clarification meetings to get clarify any item in the bid evaluation report.
- 31.3 The notification of award and its acceptance by the bidder will constitute the formation of the Contract, binding the Employer and the bidder till signing of the

  
**Muhammad Muaz**  
C.E (P/Line)  
Ext: 5065



formal Contract Agreement.

- 31.4 Upon furnishing by the successful bidder of a Performance Security, the Employer will promptly notify the other bidders that their Bids have been unsuccessful and return their bid securities.

### **IB.32 Performance Security**

- 32.1 The successful bidder shall furnish to the Employer a Performance Security in the form and the amount stipulated in the Bidding Data and the Conditions of Contract within a period of 28 days after the receipt of Letter of Acceptance.
- 32.2 Failure of the successful bidder to comply with the requirements of Sub- Clause IB.32.1 or Clauses IB.33 or IB.35 shall constitute sufficient grounds for the annulment of the award and forfeiture of the Bid Security.

### **IB.33 Signing of Contract Agreement**

- 33.1 Within 14 days from the date of furnishing of acceptable Performance Security under the Conditions of Contract, the Employer will send the successful bidder the Contract Agreement in the form provided in the Bidding Documents, incorporating all agreements between the parties.
- 33.2 The formal Agreement between the Employer and the successful bidder shall be executed within 14 days of the receipt of the Contract Agreement by the successful bidder from the Employer.

### **IB.34 General Performance of the Bidders**

The Employer reserves the right to obtain information regarding performance of the bidders on their previously awarded contracts/works. The Employer may in case of consistent poor performance of any Bidder as reported by the employers of the previously awarded contracts, interalia, reject his bid and/or refer the case to the Pakistan Engineering Council (PEC). Upon such reference, PEC in accordance with its rules, procedures and relevant laws of the land take such action as may be deemed appropriate under the circumstances of the case including black listing of such Bidder and debarring him from participation in future bidding for similar works.

### **IB.35 Integrity Pact**

The Bidder shall sign and stamp the Integrity Pact provided at Appendix-L to Bid in the Bidding Documents for all Federal Government procurement contracts exceeding Rupees ten million. Failure to provide such Integrity Pact shall make the bidder non-responsive.



**BIDDING DATA**





legislation shall be reimbursed / deducted as per Sub-Clause 70.2 of the General Conditions of Contract Part-I.

- 12.4 The rates and prices quoted by the bidders are subject to adjustment during the performance of the Contract in accordance with the provisions of Clause 70 of the Conditions of Contract. The bidders shall furnish the prescribed information for the price adjustment formulae in Appendix-C to Bid, and shall submit with their bids such other supporting information as required under the said Clause.

#### **IB.13 Currencies of Bid and Payment**

- 13.1 The unit rates and the prices shall be quoted by the bidder entirely in Pak rupees. A bidder expecting to incur expenditures in other currencies for inputs to the Works supplied from outside the Employer's country (referred to as the "Foreign Currency Requirements") shall indicate the same in Appendix-B to Bid. The proportion of the Bid Price (excluding Provisional Sums) needed by him for the payment of such Foreign Currency Requirements either (i) entirely in the currency of the Bidder's home country or, (ii) at the bidder's option, entirely in Pak rupees provided always that a bidder expecting to incur expenditures in a currency or currencies other than those stated in (i) and (ii) above for a portion of the foreign currency requirements, and wishing to be paid accordingly, shall indicate the respective portions in his bid.

- 13.2 The rates of exchange to be used by the bidder for currency conversion shall be the TT&OD Selling Rates published or authorized by the State Bank of Pakistan prevailing on the date 28 days prior to the deadline for submission of bids.

For the purpose of payments, the exchange rates used in bid preparation shall apply for the duration of the Contract.

#### **IB.14 Bid Validity**

- 14.1 Bids shall remain valid for the period stipulated in the Bidding Data after the Date of Bid Opening specified in Clause IB.23.
- 14.2 In exceptional circumstances, prior to expiry of the original bid validity period, the Employer may request that the bidders extend the period of validity for a specified additional period which shall in no case be more than the original bid validity period. The request and the responses thereto shall be made in writing. A bidder may refuse the request without forfeiting his Bid Security. A bidder agreeing to the request will not be required or permitted to modify his bid, but will be required to extend the validity of his Bid Security for the period of the extension, and in compliance with Clause IB.15 in all respects.

#### **IB.15 Bid Security**

- 15.1 Each bidder shall furnish, as part of his bid, a Bid Security in the amount stipulated in the Bidding Data in Pak Rupees.
- 15.2 The Bid Security shall be, at the option of the bidder, in the form of Pay Order or

**BIDDING DATA**

The following specific data for the Works to be bided shall complement, amend, or supplement the provisions in the Instructions to Bidders. Wherever there is a conflict, the provisions herein shall prevail over those in the Instructions to Bidders.

**Instruction to Bidders Clause Reference****1.1 Scope of Bid:**

Ref: Vol-I (BOQ)  
Ref: Vol-II (SCOPE of WORK & SPECIFICATIONS)  
Ref: Vol-III (Detail Drawings)

**1.2 COMPLETION TIME:**

The time completion as specified in Appendix-A to Bid of the whole work by the construction contractor. As OGDCL has to meet its obligations for supply of Oil & Gas owing to critical energy crises being faced by the country. The work shall be completed within period of **60 days** from possession of site issue by Engineer Incharge. The delay on part of OGDCL shall be excluded from project completion time unless verified by the Engineer In-charge on daily progress format.

**2.1 Source of Funds**

Fully deleted.

**3.1 (b) Fully deleted.**

(c) Add New Para:  
Must fulfill mandatory requirement, Technical and Financial Evaluation Criteria as specified in tender documents.

**8.1 Time limit for clarification:**

In Line 4, delete the following text:

“The Employer will respond to any request for clarification which he receives earlier than 28 days prior to the deadline for submission of bids”.

and replace with the following:

No request for clarification will be entertained/received later than **five working days (05)** days prior to the date fixed for submission of the bid. The Employer’s response will be made not later than 3 days prior to the date fixed for submission of a bid.



## 9 Amendment in Bidding Documents:

## 9.2 In Line 2, delete the following text:

“Shall be communicated in writing to all purchasers of the Bidding Documents. Prospective bidders shall acknowledge receipt of each addendum in writing to the Employer”

and replace with the following:

Shall be uploaded on OGDCL website.

## 10.1 Bid Language:

English

## 11 Documents accompanying the bid:

## 11.1 (b) (vi)

- **Technical bid** shall consist on the basis of minimum but not limited to:
  - Compliance Sheet (Annexure – I) – Duly fill, Sign & Stamp.
  - General Information (Attachment – 1)
  - Mandatory documents as per requirement.
- **Financial Bid** shall consist on the basis of minimum but not limited to the followings:
  - Bidding Form (Original) – Sign and Stamp
  - BOQ (Original) – Sign and Stamp

## 11.2 (f) Format of Responsibility Matrix

The bidder shall also submit agreement b/w JV partners given the relationship and their responsibilities. The format for responsibility matrix is attached at **Annexure-II** and mandatory to submitted along with JV agreement with clearly define each partner responsibilities in term of lead partner, coordination, execution, supervision, management, commissioning, etc.

13 Bidders to quote entirely in **Pak Rupees** only and no foreign currency are admissible.

## 14.1 Period of Bid Validity:

**180 days** from the submission/opening of the Bids.

Muhammad Muaz  
C.E (P/Line),  
Ext: 5065



## 15 Bid Security:

- 15.1 Bid must be accompanied by a Bid Bond of Minimum amount i.e., **PKR 0.5 Million** in the form of Cash Deposit Receipt (CDR) or a Bank Draft or a Bank Guarantee issued by scheduled Bank of Pakistan or a branch of Foreign Bank operating in Pakistan, except NIB & Summit Bank.
- 15.2 Bid Bond will not be acceptable with the banks whose market price per share is quoted below the par value at the Stock Exchange.
- 15.3 Bid Security is valid for **210 Days** from the date of Technical Bid Opening.
- 15.4 The Bid Security may be forfeited:
- (a) If the bidder withdraws his bid except as provided in Sub-Clause 22.1;
  - (b) If the bidder submits forged or fake bidding documents
  - (c) If the bidder does not accept the correction of his Bid Price pursuant to Sub- Clause 27.2 hereof; or
  - (d) In the case of the successful bidder, if he fails within the specified time limit to:
    - (i) Furnish the required Performance Security; or
    - (ii) Sign the Contract Agreement.

## 17.1 Venue, time, and date of the pre-Bid meeting:

A pre-bid meeting will be convened for the purpose of clarifying issues and answering questions on any matter that may be raised at that stage. Bidders or their official representatives are advised to attend the conference which will be held in the office of ----- on date which will be communicated later.

19.0 **Sealing and Marking of Bids**

Employer is following **Single Stage- One Envelop bidding process as per PPRA.**

## 19.2 The outer sealed envelope shall be marked and addressed as follows:

**General Manager Supply Chain Management (SCM)**

OIL AND GAS DEVELOPMENT COMPANY LIMITED (OGDCL)

OGDCL house, Jinnah Avenue Islamabad.

Phone # 92-51-920023540, Fax # 92-51-9215090

**DO NOT OPEN BEFORE** \_\_\_\_\_ **As per Advertisement Date**

The sealed envelope shall indicate the name and address of the Bidder to enable the bid to be



returned unopened in case it is declared LATE.

Employer shall not be responsible for the premature opening or misplacement of any Bid not clearly marked and addressed in accordance with Instruction above.

20.1(a) Deadline for submission of bids:

“The bids can be delivered in the mentioned office on the schedule mentioned in tender notice and the same will be opened accordingly in presence of bidder’s representative.”

23.1 Venue, time, and date of Bid opening:

As per press advertisement.

28.5 The Employer reserves the right to accept or reject any variation, deviation or alternative offer.

29.3

**a- MANDATORY REQUIRED FOR ACCEPTANCE OF BID**

Technical evaluation will be based upon Criteria given in clause 29.3(b) herewith. All Bidder(s) and each partner of a joint venture must qualify for each of the followings which are **mandatory** otherwise bid(s) declare non-responsive without marking:-

**i. Qualifying Marking Criteria:**

Overall aggregate marks for qualifying will be 70%. However, minimum qualifying marks for each of the categories given in technical Evaluation Criteria are 60% and mandatory.

**ii. Valid PEC License:**

License required by both local and foreign bidders for **category i.e., C-6 (Upto 25 Million)** or above in the respective **field of specializations i.e., CE08 (Oil & Gas Pipelines)**

If applied for renewal/up-gradation of License, bidder(s) must provide last year PEC valid License, good quality copy of Challan submitted to PEC and covering letter. Renewed/upgraded PEC License shall be provided within 15 days from the bid opening/submission date, otherwise bid declare non-responsive.

**iii. Registrations:**

The copy of NTN & GST and Provincial Registration by all bidders.

Muhammad Muzaz  
C.E (P/Line)  
Ext: 5065



iv. **Engineer(s) – To Be Deployed**

Must having degree in Mechanical / Metallurgy Engineering & relevant pipeline construction experience in Oil and Gas Sector.

v. **Joint Venture (If any):**

If, two or more bidders (local or foreign) to bid as **one venture** to construct a project as per “**PEC Bye-Laws**” having respective categories & field of specializations as specified in clause 29.3.a(ii) of bidding data herewith. JV must comply with the following requirements:

1. All JV partners as per their responsibilities (Financial and Construction) must comply with relevant experience, Equipment, Financial & Personal capabilities and others as per laid down technical evaluation criteria.
2. Must provide **JV agreement** judicial stamp paper as per PEC Bye-Laws along with responsibility matrix (Annexure-II) & MOU b/w parties and must confirm and mentioned that lead partner who execute the project, brief descriptions and scope of work for which JV intends to participate in bidding and for execution of project, so as to be legal binding on all partners.
3. The foreign bidder must bid as a JV with a Pakistani Constructor specifying leading party role, Financial Shares JV partner, Liabilities and responsibility of each party as per PEC Bye-Laws.
4. Contract shall be awarded to leading Partner Company nominated by all JV partners supported by Power of Attorney.
5. The portion of the work to be carried out by each partner shall be very clearly identified.
6. One of the partners shall be nominated, as being incharge and its authorization shall be evidenced by submitting power of attorney signed by legally authorized signatories of all the partners.
7. The partners incharge shall be authorized to incur liabilities and receive instructions for and on behalf of any and all partners of the JV and the entire execution of the contract including payment shall be done exclusively with the partner incharge.
8. All partners of the JV shall be jointly and severally responsible for the execution and completion of the contract in accordance with the contract terms and conditions.
9. Only one such bidder shall be eligible to bid or compete for specific project as a one venture.
10. No changes in agreement & MOU will be acceptable after awarding/signing of contract.
11. Bids shall be sign by all members in the JV.

**b- TECHNICAL EVALUATION CRITERIA**

Marking for technical evaluation will be based on criteria given in **Annexure-III**. Bidder(s) includes each partner of a JV, should provide all information, documents as per criteria. Overall aggregate marks for qualifying will be 70%. However, minimum qualifying marks for each of the categories given in technical Evaluation Criteria are 60% and mandatory.

A general criteria for technical evaluation as follows:

#	Name of Bidder (s)	Mandatory Requirements (Ref: Clause 29.3-a of Bidding Data)	(A) Relevant Experience (Oil & Gas Sector) Completion / performance certificates required* (35)	(B) Personal Capacities – To Be Deploy* (20)	(C) Equipment Capabilities (Owned/Leased) – To Be Deploy* (20)	(D) Financial soundness (20)*	(E) HSEQ (5)*	(F) Arbitration / Litigation (-10)*	Total Marks (100)*	Remarks (Responsive/Non-Responsive)
1										

\* Note: 1. Detail criteria for each category is given in Annexure-III

2. Any bidder not fulfilling mandatory requirement as per clause 29.3(a) will not be qualified and bid stands rejected without considering technical evaluation criteria.

32.1 Form and amount of Performance Security/Bank Guarantee acceptable to the Employer: Bank Guarantee from any Scheduled Bank of Pakistan (Except M/S NIB & Summit Bank) for an amount equal to 10% of the total Contract Price stated in the Letter of Acceptance.

**Muhammad Muaz**  
C.E (P/Line)  
Ext: 5065



**ANNEXURE – I**

**COMPLIANCE SHEET**

**(To be submitted along with Technical Bid)**

  
**Muhammad Muaz**  
C.E (P/Line)  
Ext: 5065



**COMPLIANCE SHEET**

SR#	Description	Lead Partner	JV Partner 1 *	JV Partner 2 *
		Comply / Not Comply		
<b>A</b>	<b>MANDATORY REQUIREMENTS FOR ACCEPTANCE OF BID</b> (Ref: Clause 29.3(a) of Bidding Data)			
1	Qualifying Marking Criteria			
2	Valid PEC License in C-6 (Upto 25Million) Category & field of specialization CE-08 (Oil and Gas pipelines)			
3	Registrations			
4	Engineer (To be deploy)			
5	JV Agreement & MOU (If any)			
<b>B</b>	<b>BIDDING DOCUMENTS</b>			
1	Covering Letter			
2	General Information (Attachment 1)			
3	Authority letter on company / JV letter head.			
4	Bid Validity - 180 Days (Ref: Clause 14 of Bidding Data)			
5	Compliance Sheet (Annexure-I)			
6	Bid Security – Rs 0.5 Million (Ref: Clause 15 of Bidding Data)			
7	Original Bid Security (Submitted along with Technical Bid)			
8	Bid Security Validity – 210 Days (Ref: Clause 15 of Bidding Data)			
9	Completion Time – 60 Days (Ref: Clause 1.2 of Bidding Data)			

  
Muhammad Muaz  
C.E (P/Line)  
Ext: 5065



10	Company Profile(s)			
11	Relevant experience (Ref: Technical Evaluation criteria)			
12	Personal Capabilities – To be deploy (Ref: Technical Evaluation criteria)			
13	Equipment capabilities – To be deploy (Ref: Technical Evaluation criteria)			
14	Financial Soundness (Ref: Technical Evaluation criteria)			
15	All relevant Work orders, Completion, Substantial, Performance certificate, etc. (As per Technical criteria)			
16	CV's of Qualified Engineer's/manpower to be deployed			
17	List of Clients with ongoing projects			
18	List of Clients with completed projects			
19	Working methodology, plan and procedure			
20	Organogram & Equipment deployment List			
21	Project Schedule / Gantt Chart			
22	Format for Daily, weekly and monthly report acceptable to Employers Engineer In charge.			
23	Affidavit as per given format (On Rs 100/- Stamp Paper)			
24	Integrity Pact as per given format (On Rs 100/- Stamp Paper)			
25	Bidding Form as per given format			
26	Original Un-priced BOQ with sign and stamp.			
27	All bidding documents will be fully sign and stamp (1 Original + 1 Copy) by authorized person / lead partner. In case of JV, must be sign & Stamp by each partner.			
28	No deviation & conditional bid shall be accepted.			
29	The Overall aggregate marks for qualifying will be 70%. However, minimum qualifying marks for each of the categories given in technical Evaluation Criteria are 60% and mandatory. (As per clause 29.3-b of bidding data – Marks			



	distribution given in Annexure-III).			
30	Radiography & 3 <sup>rd</sup> Party Inspection shall be arranged by OGDCL as its own cost as per SCOPE of WORK, BOQ, Drawings and standard practice and qualified procedures. Contractor shall comply that any sort of information and documents required by Inspector and/or Engineer In-charge before, during and after execution of work shall be provided and any deficiency, defect, remedy identify shall be rectify at the cost of Contractor.			
31	Written approval require from Engineer Incharge before starting any construction works.			

\* Bidder(s) may add further JV partner details as per above format.

**Sign & Stamp**  
(By Bidder 's)

**Muhammad Muaz**  
C.E (P/Line)  
Ext: 5065



**ANNEXURE – II**

**FORMAT OF RESPONSIBILITY MATRIX**

  
**Muhammad**  
C.E (P/Line,  
Ext: 5065

**FORMAT OF RESPONSIBILITY MATRIX**

S. No.	Responsibilities	(Lead JV Partner)	(JV Partner 1 or 2 or 3...)*
1.	Liaison with client and external interfaces		
2.	Planning, Scheduling & Progress Monitoring		
3.	Cost & Financial Control		
4.	Execution at Site		
5.	Overall Project Management		
6.	Construction Supervision		
7.	Construction Management		
8.	**		
10.			
11.			
12.			

\* As many number of columns can be inserted as the partners in JV / Consortium

\*\* Bidder(s) may add further responsibilities as per there agreement.

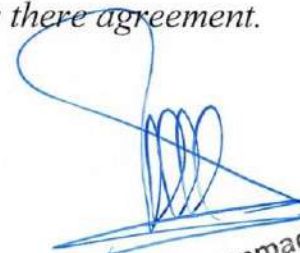
  
Muhammad Nwaz  
C.E. (P/Line)  
Ext: 5065



**ANNEXURE – III**  
**TECHNICAL EVALUATION CRITERIA**

**Muhammad Muaz**  
C.E (P/Line)  
Ext: 5065



**Annexure – III**

**TECHNICAL EVALUATION CRITERIA**

➤ **MANDATORY REQUIREMENTS FOR ACCEPTANCE OF BID:**

1. Qualifying marking criteria
2. Valid PEC License in Category C-6 (Upto 25Million) & field of specialization CE-08 (Oil and Gas pipeline )
3. Registrations
4. Engineer – To be Deploy
5. JV Agreement & MOU (If any)

➤ **GENERAL MARKING CRITERIA:**

#	Name of Bidder (s)	Mandatory Requirements (Ref: Clause 29.3-a of Bidding Data)	(A) Relevant Experience (Oil & Gas Sector) Completion / performance certificates required* (35)	(B) Personal Capacities – To Be Deploy* (20)	(C) Equipment Capabilities (Owned/Leased) – To Be Deploy* (20)	(D) Financial soundness (20)*	(E) HSEQ (5)*	(F) Arbitration / Litigation (-10)*	Total Marks (100)*	Remarks (Responsive/Non-Responsive)
1										

➤ **DETAIL MARKING CRITERIA:**

#	DESCRIPTION	WEIGHTAGE		Total
A		Qty x Marks		
<b>RELEVANT EXPERIENCE (OIL AND GAS SECTOR)</b>				
1	List of Projects of similar nature completed during <b>last 10 years</b> (with completion / Performance certificate*). <u>Marking Criteria:</u> ➤ Each Project of minimum 500 Dia Inch or above carry 8 marks. ➤ Project less than 500 Dia Inch will be given zero marks	3	3x8=24	<b>35</b>
2	List of On-going / current contract commitments / projects of similar nature (with Work orders/substantial completion certificate *). <u>Marking Criteria:</u> ➤ Each Project of minimum 500 Dia Inch or above carry 5.5 marks. ➤ Project less than 500 Dia Inch will be given zero marks.	2	2x5.5=11	
* Valid Certificates are mandatory for marking.				

**Muhammad Muaz**  
 C.E (P/Line)  
 Ext: 5065



<b>B PERSONAL CAPACITIES</b>			
<b>1</b>	<b>SITE ENGINEER</b>		
	Having relevant Pipeline / Process piping, Welding, Testing & Commissioning experience of Oil & gas sector (Must having BSc Engineering degree in Mechanical/Metallurgy).*	1	1 x 6 = 6
<b>2</b>	<b>SUPERVISOR / STAFF</b>		
<b>i.</b>	Site supervisor having relevant Pipeline / Process piping, Welding, Testing & Commissioning experience of Oil & Gas sector (Must having DAE in Mechanical/Metallurgy).*	1	1 x 4 = 4
<b>ii.</b>	List of Qualified welders to be attached (Must having relevant experience with welder qualification certificate)	4	4 x 1 = 4
<b>iii.</b>	List of all technical skilled manpower: a- Fabricator (02 Nos.) b- Hydro testing teams (02 Nos.) c- Sand blaster (01 No) & Painter (01 No)	2 1 2	2 x 1 = 2 1 x 2 = 2 2 x 1 = 2
	* Detailed CV required for marking		
<b>C EQUIPMENT CAPABILITIES (Owned/leased)</b>			
<b>i.</b>	Welding Plants (1 marks for one Unit)	6	6 x 1 = 6
<b>ii.</b>	Grinders (0.5 marks for one Unit)	6	6 x 0.5 = 3
<b>iii.</b>	Cutting and beveling machine (1 marks for one Unit)	2	2 x 1 = 2
<b>iv.</b>	Crane (2 marks for one Unit)	2	2 x 1 = 2
<b>v.</b>	Hydro testing equipment with water filling and pressure pump capable for 3000 PSI or above (4 marks for one Unit).	1	1 x 4 = 4
<b>vi.</b>	Air compressor of required pressure. (3 marks for one Unit)	1	1 x 3 = 3
<b>D FINANCIAL SOUNDNESS</b>			
<b>i.</b>	Average Annual turnover upto 20Million	1	1 x 6 = 6
<b>ii.</b>	Audit reports of last 3 years showing financial strength with balance sheet	3	3 x 4 = 12
<b>iii.</b>	Satisfactory bank certificate of financial soundness.	1	1 x 2 = 2
<b>E</b>	<b>HSEQ</b>	1	1 x 5 = 5
<b>F</b>	<b>ABRITRATION / LITIGATION</b>	1	1x-10=-10
			<b>Grand Total</b>
			<b>100</b>

**NOTE:**

- Overall aggregate marks for qualifying will be 70%. However, minimum qualifying marks for each of the categories given in technical Evaluation Criteria are 60% and mandatory. All the information provided shall be supported with documentary evidence duly signed and stamped by Bidder & JV partners along with technical bid.
- Any bidder not fulfilling mandatory requirement as per clause 29.3(a) will not be qualified and bid stands rejected without marking.
- Engineer and required manpower be deployed till completion of the Project.
- Contractors Engineer is responsible for signing, coordination in all respect with Employer/OGDCL Engineer Incharge. The deployed machinery, tools, equipment shall be good site worthy conditions and shall be fit for use.

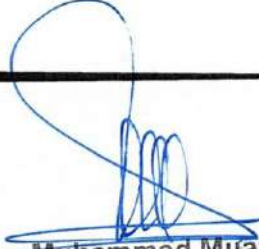
  
**Muhammad Muaz**  
 C.E (P/Line)  
 Ext: 5065





**ATTACHMENT 1**  
**GENERAL INFORMATION**

  
**Muhammad Muaz**  
C.E (P/Line)  
Ext: 5065

**GENERAL INFORMATION**

All bidder(s) and each partner of JV shall provide the complete information as per below format. Nationality information is also to be provided for foreign bidder(s) who are forming part of the JV as required under PEC Bye-Laws.

Name of Company / Lead Partner / Applicant: _____	
Telephone# _____	Fax# _____ Email: _____
Permanent Office Address: _____	
Place of Incorporation/Registration: _____	Year: _____
Pakistan Engineering Council # _____	Validity (Year): _____ Category: _____
1	Field of Specialization(s): _____ Applied for Renewal / Up-gradation: <u>YES / NO</u>
	Registration(s): 1. NTN# _____ 2. GST# _____
	3. Provisional Sale Tax # for each province:
	i. ICT#: _____ Registered / Un-Registered.
	ii. PUNJAB#: _____ Registered / Un-Registered.
	iii. SINDH#: _____ Registered / Un-Registered.
	iv. BALOCHISTAN#: _____ Registered / Un-Registered.
	v. KPK#: _____ Registered / Un-Registered.
Company / Lead Partner / Applicant Bank Details:	
Bank Name: _____	Branch Name: _____ Account# _____
Address: _____	IBAN#(24 Digit): _____
2	Contact Name: _____ Title / Designation: _____
	Telephone: _____ Fax: _____
Company Lead Partner / Applicant Owner Name: _____ Mobile# _____	
Email: _____ CNIC# (Attach attested copy) _____	
3	Director(s) Details – If any:
	1. _____ Email: _____ Mobile# _____ CNIC# (Attach attested copy) _____
	2. _____ Email: _____ Mobile# _____ CNIC# (Attach attested copy) _____
	3. _____ Email: _____ Mobile# _____ CNIC# (Attach attested copy) _____



	Name of JV Partner (1): _____
	Telephone# _____ Fax# _____ Email: _____
	Permanent Office Address: _____
	Place of Incorporation/Registration: _____ Year: _____
	Pakistan Engineering Council # _____ Validity (Year): _____ Category: _____
	Field of Specialization(s): _____ Applied for Renewal / Up-gradation: <u>YES / NO</u>
	Registration(s): 1. NTN# _____ 2. GST# _____ 3. Provisional Sale Tax # for each province:
	i. ICT#: _____ Registered / Un-Registered.
	ii. PUNJAB#: _____ Registered / Un-Registered.
	iii. SINDH#: _____ Registered / Un-Registered.
	iv. BALOCHISTAN#: _____ Registered / Un-Registered.
	v. KPK#: _____ Registered / Un-Registered.
4	Name of JV Partner (2): _____
	Telephone# _____ Fax# _____ Email: _____
	Permanent Office Address: _____
	Place of Incorporation/Registration: _____ Year: _____
	Pakistan Engineering Council # _____ Validity (Year): _____ Category: _____
	Field of Specialization(s): _____ Applied for Renewal / Up-gradation: <u>YES / NO</u>
	Registration(s): 1. NTN# _____ 2. GST# _____ 3. Provisional Sale Tax # for each province:
	i. ICT#: _____ Registered / Un-Registered.
	ii. PUNJAB#: _____ Registered / Un-Registered.
	iii. SINDH#: _____ Registered / Un-Registered.
	iv. BALOCHISTAN#: _____ Registered / Un-Registered.
	v. KPK#: _____ Registered / Un-Registered.
5	Authorized Person Name (On behalf of Applicant): _____ Mobile# _____
	CNIC# (Attach attested copy) _____ Designation: _____ Email: _____
	<u>(Responsibilities must be define in authority letter)</u>

Note: Bidder(s) may provide/attached additional information.



**BIDDING FORM,**  
**APPENDICES TO BID**  
**AND**  
**AFFIDAVIT**

**Muhammad Muaz**  
C.E (P/Line)  
Ext: 5065



**BIDDING FORM**

Date.....  
Tender Enquiry No. ....

To  
**Oil & Gas Development Company Limited,  
OGDCL House, Plot # 3013,  
Blue Area, Islamabad  
Gentlemen,**

Having examined the conditions of contract, scope of work and Instructions to bidders of Invitation to Bids, the receipt of which is hereby acknowledged, we the undersigned, offer to perform services (Nature of Service) to OGDCL in conformity with the scope of work and Instructions to bidders at the rates mentioned in our Bid Proposal or other such sums as may be ascertained in accordance with the said conditions.

2. We confirm that the terms and conditions given in the Tender Enquiry / Tender Documents are acceptable to us and if our Bid is accepted we shall execute a contract with OGDCL accordingly without any exceptions. We further confirm to commence service within .....days of the mobilization notice issued by OGDCL.

3 We agree to validate bid unconditionally for the period of 180 days from the date of opening the same and it shall remain binding upon us and may be accepted thereof, shall constitute a binding contract between us.

4. We hereby certify that our Firm / Company / Local Agent is or has not been at any time during the past five years, involved in litigation, arbitration or any other unsettled dispute with OGDCL / JV Partners.

5. We further certify that all the contracts / orders placed on us by OGDCL / JV Partners have been executed timely and as per terms & conditions of the Contract / order without any unsettled dispute.

6. Until a formal Agreement is prepared and executed, this bid, together with your acceptance thereof, shall constitute a binding contract between us.

7. We understand that you are not bound to accept the lowest or any tender you may receive.

8. Our bid proposal do not contain any deviation or exceptions from the terms & conditions enunciated in the tender documents.

Dated this.....days of..... (year) 201---,

Name & Signature.....in the Capacity of.....

duly authorized to sign tenders for and on behalf of.....

(Name of the firm in block capital Letters)

Address.....

Telex No.....Fax No.....Phone No.....

Witness

1. ....  
(Name)

(Signature)

2. ....  
(Name)

(Signature)

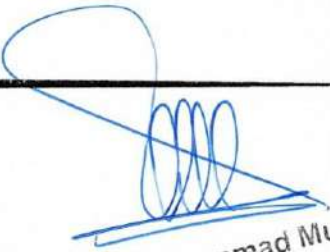
  
**Muhammad Muaz**  
C.E (P/Line)  
Ext: 5065

**SPECIAL STIPULATIONS Clause**

1.	Engineer's Authority to issue Variation in emergency	2.1	To convey after approval in accordance with the rules and regulations of the Employer.
2.	Minimum Amount of Performance Security	10.1	10% of total Contract Price stated in the Letter of Acceptance in the form of bank guarantee.
3.	Time for Furnishing Programme	14.1	Within 10 days from the date of receipt of Letter of Acceptance.
4.	Minimum amount of Third Party Insurance	23.2	Rs. 500,000/- (Five Hundred Thousands) per occurrence with number of occurrences unlimited.
5.	Time for Commencement	41.1	Within 07 days from the date of receipt of Engineer's Notice to Commence.
6.	Time for Completion	43.1, 48.2	<b>60 days Calendar days</b> from the date of receipt of Engineer's Notice to Commence.
7.	Amount of Liquidated Damages	47.1	0.1 % of the Contract Price for each day of delay in completion of the Works subject to a maximum of 10% of Contract Price stated in the Letter of Acceptance.
8.	Defects Liability Period	49.1	One (01) Year from the effective date of Taking Over Certificate.
9.	Percentage of Retention Money	60.2	10% of the amount of Interim Payment Certificate.
10.	Limit of Retention Money	60.2	5 % of Contract Price stated in the Letter of Acceptance.
11.	Minimum amount of Interim Payment Certificates (Running Bills)	60.2	Rs 5,000,000/-
12.	Time of Payment from delivery of Engineer's Interim Payment Certificate to the Employer.	60.10	As per Employer's procedure.
13.	Mobilization Advance * (Interest Free)	60.12	10% of Contract Price stated in the Letter of Acceptance subject to provision of B/G from scheduled banks of Pakistan
14.	Price Adjustment Clause		This Clause is deleted and no escalation allowed.
15.	Bid Security		<b>PKR 0.5 Million</b> in the form of pay order or demand draft or Bank Guarantee must accompany the technical bids.

\* Delete if alternative one is not adopted.



**Appendix-D to Bid**

# **BILL OF QUANTITIES**

*(Attach Separately)*

  
**Muhammad Muaz**  
C.E (P/Line)  
Ext: 5065



## Appendix-E to Bid

**PROPOSED CONSTRUCTION SCHEDULE**

Pursuant to Sub-Clause 43.1 of the General Conditions of Contract, the Works shall be completed on or before the date stated in Appendix-A to Bid. The Bidder shall provide as Appendix-E to Bid, the Construction Schedule in the bar chart (CPM, PERT or any other to be specified herein) showing the sequence of work items and the period of time during which he proposes to complete each work item in such a manner that his proposed programme for completion of the whole of the Works and parts of the Works may meet Employer's completion targets in days noted below and counted from the date of receipt of Engineer's Notice to Commence (Attach sheets as required for the specified form of Construction Schedule):

**Description****Time for Completion**

Whole Works

60 days





BF-1

**Appendix-F to Bid**

**METHOD OF PERFORMING THE WORK**

[The Bidder is required to submit a narrative outlining the method of performing the Work. The narrative should indicate in detail and include but not be limited to:

1. Organization Chart indicating head office and field office personnel involved in management and supervision, engineering, equipment maintenance and purchasing.
2. Mobilization in Pakistan, the type of facilities including personnel accommodation, office accommodation, provision for maintenance and for storage, communications, security and other services to be used.
3. The method of executing the Works, the procedures for installation of equipment and machinery and transportation of equipment and materials to the site.]



BG-1

Appendix-G to Bid

**LIST OF MAJOR EQUIPMENT – RELATED ITEMS**

**(To be used by the Bidder)**

[The Bidder will provide on Sheet 2 of this Appendix a list of all major equipment and related items, under separate heading for items owned, to be purchased or to be arranged on lease by him to carry out the Works. The information shall include make, type, capacity, and anticipated period of utilization for all equipment which shall be in sufficient detail to demonstrate fully that the equipment will meet all requirements of the Specifications.]



BH-1

**Appendix-H to Bid**

**CONSTRUCTION CAMP AND HOUSING FACILITIES**

The Contractor in accordance with Clause 34 of the Conditions of Contract shall provide description of his construction camp's facilities and staff housing requirements.

The Contractor shall be responsible for pumps, electrical power, water and electrical distribution systems, and sewerage system including all fittings, pipes and other items necessary for servicing the Contractor's construction camp.

The Bidder shall list or explain his plans for providing these facilities for the service of the Contract as follows:

1. Site Preparation (clearing, land preparation, etc.).
2. Provision of Services.
  - a) Power (expected power load, etc.).
  - b) Water (required amount and system proposed).
  - c) Sanitation (sewage disposal system, etc.).
3. Construction of Facilities
  - a) Contractor's Office, Workshop and Work Areas (areas required and proposed layout, type of construction of buildings, etc.).
  - b) Warehouses and Storage Areas (area required, type of construction and layout).
  - c) Housing and Staff Facilities (Plans for housing for proposed staff, layout, type of construction, etc.).
4. Construction Equipment Assembly and Preparation (detailed plans for carrying out this activity).
5. Other Items Proposed (Security services, etc.).



BI-1

Appendix-I to Bid

**LIST OF SUBCONTRACTORS**

I/We intend to subcontract the following parts of the Work to subcontractors. In my/our opinion, the subcontractors named hereunder are reliable and competent to perform that part of the work for which each is listed.

Enclosed are documentation outlining experience of subcontractors, the curriculum vitae and experience of their key personnel who will be assigned to the Contract, equipment to be supplied by them, size, location and type of contracts carried out in the past.

<b>Part of Works (Give Details)</b>	<b>Subcontractor (With Complete Address)</b>
<b>1</b>	<b>2</b>

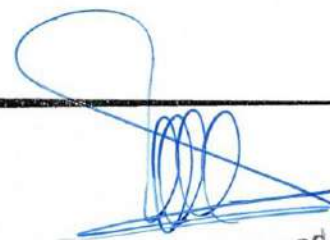
  
**Muhammad Muaz**  
C.E (P/Line)  
Ext: 5065



BJ-1

Appendix-J to Bid

ESTIMATED PROGRESS PAYMENTS

**Payment will be made on actual work done bases.**

  
Muhammad Mtiqz  
C.E (P/Line)  
Ext: 5065



**BK-1**

**Appendix-K to Bid**

**ORGANIZATION CHART FOR THE  
SUPERVISORY STAFF AND LABOUR**

  
**Muhammad Muaz**  
C.E (P/Line)  
Ext: 5065



**Appendix-L to Bid**

**LIST OF BIDDER DRAWINGS**

(Bidder Drawings are Attached Separately as Volume-III)



**Appendix-M to Bid**

(On official letter-head of the bidder)  
To be signed by the  
Chief Executive of the  
Bidding company or a representative duly  
Authorized by board  
Resolution.

**INTEGRITY AND ETHICS UNDERTAKING**

We hereby commit and undertake to observe the following principles during our participation in the tender process and during the contract execution:

- i. That we will not directly or through any other person of firm, officer promise or give to any of the employees of OGDCL involved in the tender process or execution of the contract any gain, pecuniary benefit of facilitation payment in order to obtain in exchange any advantages of any kind whatsoever during the tender process or during the execution of contracts.
- ii. That we have not and will not enter with other bidders into any undisclosed agreement or undertaking either formal or informal to restrict competitiveness sort to cartelise in the bidding process.
- iii. That we will ensure that the remuneration of agents (if engaged) is appropriate and for legitimate services only.
- iv. That we will not use subcontracts, purchase orders or consulting agreements as means of channeling payments to employees of OGDCL.
- v. That we will not commit any offence under the Pakistan Penal Code, Prevention of Corruption Act or National Accountability Ordinance to achieve any advantage, gain or benefit during the tender process or the execution of the contract.

We further understand and acknowledge that any violation of transgression of the above mentioned principles will attract disqualification from the tender process and may also result in permanent exclusion from future contract award process.

We also accept and undertaking to respect and uphold OGDCL's absolute right to resort to and impose such disqualification, debarment or execution.

For and on behalf of \_\_\_\_\_

Tender No. \_\_\_\_\_

  
Muhammad Muaz  
C.E (P/Line)  
Ext: 5065





**A F F I D A V I T**  
**(To be attached with Technical bid)**

I, \_\_\_\_\_ S/o \_\_\_\_\_ aged \_\_\_\_\_ years  
\_\_\_\_\_ working as Proprietor/Managing Partner/Director of M/s \_\_\_\_\_  
\_\_\_\_\_ having its registered  
office at \_\_\_\_\_ do hereby solemnly affirm  
and declare on oath as under:

1. That I am competent to swear this affidavit being proprietor/one or the partners/  
Director of M/s \_\_\_\_\_
2. That M/s \_\_\_\_\_ is a  
proprietorship/partnership firm/company is participating in tender process  
conducted by OGDCL.
3. That I hereby confirm and declare that none of my/our group/sister  
concern/associate company is participating/ submitting this tender.
4. That I hereby confirm and declare that my/our firm/company M/s  
\_\_\_\_\_ and my/our firm/group/company/ sister concern /  
associate company or any of its directors have not been black listed/de-listed by any  
Institutional agencies/Govt. Deptt/ Public Sector Undertaking.
5. That there is no change in the Name & Style, Constitution and Status of the firm,  
after Pre-qualification.
6. That I further undertake that in case any of the facts contained above and in-our  
application is round other-wise or incorrect or false at any stage, my/our  
firm/company/ group/sister concerns/ associate companies shall stand debarred  
from the present and future tenders of the OGDCL.

(Signature of the Proprietor/ Managing Partner/Director with Seal)

DEPONENT

Verified at \_\_\_\_\_ on \_\_\_\_\_ that the contents of paras 1 to 6 of  
this affidavit are true and correct to best of my knowledge and no part of this is false and  
nothing material has been concealed or falsely stated therein.

(Signature of the Proprietor/ Managing Partner/ Director with Seal)

DEPONENT

(Signature & Seal of Notary)

  
Muhammad Mulla,  
C.E (P/Line),  
Ext: 5065



**FORMS**

**INDEMNITY BOND  
BID BOND  
PERFORMANCE SECURITY  
CONTRACT AGREEMENT  
MOBILIZATION ADVANCE GUARANTEE/BOND**

  
**Muhammad Muaz**  
C.E (P/Line)  
Ext: 5065



**INDEMNITY BOND FOR SECURED ADVANCE**

**AGAINST THE MATERIALS FINANCED / PAID BY THE**

**OIL & GAS DEVELOPMENT COMPANY LIMITED (OGDCL) (EMPLOYER)**

INTERIM PAYMENT CERTIFICATE NO. \_\_\_\_\_

This indemnity Bond is signed, executed & issued at \_\_\_\_\_ This \_\_\_\_\_ day of \_\_\_\_\_ by \_\_\_\_\_ having its office at \_\_\_\_\_ (hereinafter called the Contractor) in favour of the OIL & GAS DEVELOPMENT COMPANY LIMITED (OGDCL) having its office at Piran ghaib road Multan. (hereinafter called the Employer).

AND WHEREAS the Contractor entered into a written Contract Agreement with the Employer dated the \_\_\_\_\_ Day of \_\_\_\_\_ for Construction of -----

AND WHEREAS the Contractor seeks Secured Advance payment from the Employer pursuant to Sub-Clause 60.11 of GCC Secured Advance on Materials' of the conditions of contract ; and the contractor has brought the following materials at the site for incorporation in the Permanent Works, and the materials have not yet been incorporated in the Permanent Works,

AND WHEREAS the Contractor undertakes and solemnly affirms that:

1. The materials are in compliance with the Technical specifications for the Permanent Works,
2. The materials have been delivered to the site and are properly stored and protected against loss or damage or deterioration,
3. The Contractor's records of the requirements, orders, receipts and use of materials at the site are kept in a form approved by the Employer, and such records shall be available for inspection by the Employer,
4. Ownership of the materials shall be deemed to vest in the Employer, and these materials shall not be removed from the site or otherwise disposed of without written permission of the Employer, and
5. The Contractor will not pledge any of the materials with any Bank or like agency or any individual.

NOW THEREFORE, through this Indemnity Bond the Contractor binds himself to exonerate, save harmless, indemnify and keep indemnified the Employer for and against any and all losses of whatsoever kind and nature relating to the materials including those due to theft, loot, arson, pilferage, wastage due to fire, rains, storm, earthquake, flood and inundation, shortage, damage,

  
**Muhammad Muaz**  
C.E (P/Line)  
Ext: 5065



deterioration and depreciation etc., of the materials, through any act of man or God, or slump in the market of the materials, financed,

Advanced or paid by the Employer on the Contractor's Request for financing / advancing/ payment.

The Contractors further declares that he will faithfully abide by the above declaration; and that in the event of his infringement of the declaration made above, the Employer will be fully entitled forfeit all such material and also proceed against the Contractor according to the relevant clause pertaining to breach of Contract and further invoke the power to seek any remedies accrued to him as the Employer under the Contract.

Further, the Contractor also authorizes the Employer to adjust the Secured Advance payment amount in full or in part from any of the Contractor's payment Certificates/bills, or adjust for the actual incorporation of these materials in the Permanent Works, without having to make any reference to the Contractor.

Details of the materials and their cost for which Secured Advance payment is being sought by the Contractor are as under:

S. No.	Type of Material	Qty in M.Ton.	@Avg.	Amount in Rs.
01	_____	_____	_____	_____
02	_____	_____	_____	_____

\_\_\_\_\_ Advance Cost of Material at site. \_\_\_\_\_

TOTAL Rs. \_\_\_\_\_

Rupees \_\_\_\_\_

Seal and Signature of the Contractor

Witnesses:

1. \_\_\_\_\_

2. \_\_\_\_\_

3. \_\_\_\_\_

  
Muhammad Muaz  
C.E (P/Line)  
Ext: 5065

**BID BOND**

Oil & Gas Development Company Limited,  
OGDCL House, Jinnah Avenue,  
Blue Area, Islamabad.

Guarantee No.....  
Date of issue.....  
Date of expiry .....

Amount.....

Dear Sir,

In consideration of M/s.....  
herein after called "THE BIDDER" having submitted the accompanying Bid with  
reference to OGDCL tender enquiry No. **PROC-SERVICES/-----** and  
in consideration of value received from (the Bidder above), we hereby agree to  
undertake as follows:-

1. To make unconditional, immediate and forthwith payment of the sum of -----  
--) upon your FIRST and SIMPLE written demand without further recourse,  
question, query, deferment, contestation or reference to the bidder, account party  
or any other person in the event of the withdrawal of the aforesaid bid by the  
BIDDER before the end of the period specified in the Bid after the opening of the  
same for the validity thereof or if no such period be specified, within 210 days  
after the said opening or if the Bidder, having been notified of the acceptance of  
his bid by the Company during the period of bid validity:
  - i. Fails, refuses or delays to execute contract as per Tender/Contract's  
terms & conditions.  
OR
  - ii. Fails, refuses or delays to furnish Performance Bond and/or Advance  
Bank Guarantees.  
OR
  - iii. Submit forged/fake document(s) in support of their bid.  
OR
  - iv. Fails to provide/ perform services as specified in TOR.
2. To accept written intimation from you as conclusive, sufficient and final  
evidence of the existence of a default of non-compliance, breach or default  
as aforesaid on the part of the BIDDER and to make payment immediately  
and forthwith upon receipt of your FIRST and SIMPLE written intimation.
3. No grant of time or other indulgence to, or composition or arrangement  
with the BIDDER in respect of the aforesaid Bid with or without notice to  
us shall affect this Guarantee and our liabilities and commitments  
hereunder.
4. This is an independent and direct obligations guarantee and shall be  
binding on us and our successor in interest and shall be irrevocable.
5. The Guarantor Bank warrants and represents that it is fully authorized,  
empowered and competent to issue this guarantee.

**Yours faithfully,  
(BANKERS)**

**Bank guarantee issued from banks mentioned in clause#15.1 of invitation to bid  
will be preferred**

  
**Muhammad Muaz**  
C.E (P/Line)  
Ext: 5065



**PERFORMANCE BOND/BANK GUARANTEE**

Oil & Gas Development Company Limited,  
OGDCL House, Jinnah Avenue,  
Blue Area, Islamabad.

Guarantee No.....  
Date of issue .....  
Date of expiry .....  
Amount.....

Dear Sir,

Ref: Our Bank Guarantee No. \_\_\_\_\_ in the sum of \_\_\_\_\_  
Account \_\_\_\_\_ Amount of Contract \_\_\_\_\_

In consideration of you having entered into contract No. \_\_\_\_\_ with \_\_\_\_\_ called Contractor and in consideration for value received from CONTRACTOR, we \_\_\_\_\_ at the request of \_\_\_\_\_ hereby agree and undertake as follows:

1. To make unconditional, immediate and forthwith payment to you as called upon of an amount (equivalent to 10% of total contract value in Pak Rupees/USD) on your written FIRST and SIMPLE demand without further recourse, question, query, deferment, contestation or reference to CONTRACTOR or any other person, in the event of default, non-performance or non-fulfillment by CONTRACTOR of his obligations liabilities, responsibilities, or in case if any forged or fake documents is found at any stage under this contract, of which you shall be the sole and absolute judge.
2. To accept written intimation from you as conclusive, sufficient and final evidence of the existence of a default or breach as aforesaid on the part of CONTRACTOR and to make payment immediately and forthwith upon receipt of your FIRST and SIMPLE written demand.
3. To keep this Guarantee in full force from the date hereof **until six months beyond the contract validity period.**
4. That no grant of time or other indulgence to, amendment in the terms of the contract by Agreement between the parties, or imposition or Agreement with contractor in respect of the performance of his obligation under and in pursuance of the said Agreement with or without notice to us, shall in any manner discharge or otherwise affect this Guarantee and our liabilities and commitments there under.
5. This is an independent and direct obligations guarantee and shall be binding on us and our successor interest and shall be irrevocable.
6. This Guarantee shall not be affected by any change in the constitution of the Guarantor Bank or the constitution of the Contractor.
7. The Guarantor Bank warrants and represents that it is fully authorized, empowered and competent to issue this guarantee.

Authorized Sign for Issuing Bank

**Seal of the Bank**

**Bank guarantee issued from banks mentioned in clause#4.2 of invitation to bid will be preferred**

*Muhammad Muaz*  
C.E (P/Line)  
Ext: 5065

**CONTRACT AGREEMENT**

CA-1

This agreement (Hereinafter called the "Contract") made on \_\_\_\_ Day of \_\_\_\_, 20\_\_ between Oil and Gas Development Company Ltd, Islamabad (Hereinafter called "The Employer") of the one part, represented by *Mr.* \_\_\_\_\_ and *M/S* \_\_\_\_\_ (Hereinafter called "Contractor") of the other part and represented by *Mr.* \_\_\_\_\_ of the *M/S* \_\_\_\_\_.

WHEREAS, the employer is desirous that certain Pipeline works should be executed.

Viz:- " \_\_\_\_\_."

**NOW THIS AGREEMENT WITNESSETH as follows:-**

1. In this contract agreement words and expressions shall have the same meanings as are respectively assigned to them in the condition of contract hereinafter referred to.
2. The following documents specifically applicable to the said works shall be deemed to form and be ready and construed, as part of this contract agreement, and together with this agreement contract shall hereinafter be referred to as the contract documents. The order in which the documents are listed shall be indicative as to their priority in the event of (hereinafter referred to as "contract documents"):
  - i.* Contract Agreement.
  - ii.* Work Order
  - iii.* Letter of Acceptance.
  - iv.* LOI.
  - v.* Authority Letter.
  - vi.* JV Agreement with Responsibility Matrix (If any)
  - vii.* Affidavit
  - viii.* Integrity Pact
  - ix.* Form's
  - x.* Ethic Undertaking
  - xi.* Proposed construction schedule with Gantt Chart
  - xii.* Method of Performing the work
  - xiii.* Camping arrangements
  - xiv.* Organization Chart
  - xv.* Technical Specifications
  - xvi.* All Drawings
  - xvii.* Priced BOQ
  - xviii.* Compliance Sheet.
  - xix.* Bidding data
  - xx.* Special Stipulations.
  - xxi.* Particular Condition of Contract.

  
**Muhammad Muaz**  
C.E (P/Line)  
Ext: 5065



- xxii.** General Condition of Contract.  
**xxiii.** Construction programme for execution of work over total period of \_\_\_\_ days.  
**xxiv.** Instruction to Tenders.  
**xxv.** Invitation of tenders.
3. The laws of Pakistan shall be the governing laws for this contract. This Contract shall have precedence over all other mentioned at Article 2 herein above.
  4. In consideration of the payments to be made by the Employer to the contractor as hereinafter mentioned the contractor hereby covenant with the Employer to execute, complete and maintain the works in conformity in all respect with the provisions of the contract and the contract documents within the contract period.
  5. The employer hereby covenant to pay the contractor in consideration of the execution, completion and maintenance of the works the contract price at the times, and in the manner prescribed by the contract documents.
  6. Payment of all running bills and final bill shall be paid within the time as required by OGDCL. No interest shall be paid to the contractor for any delay in payment at OGDCL part.
  7. Contractor is required to mobilize within Fourteen (14) days from the date of issuance of the work order/ Engineers Notice to proceed.
  8. The supervising officer will undertake to approve all contractors' material(s) and shop drawing submittals within Fourteen (14) days or sooner, from the date of their receipt.
  9. There shall be no restriction by the Employer for the overtime working of the contractor necessary to complete the works within the required time schedule and the attendance by the Employer's representative at time outside normal working hours to monitor and inspect the works will be given freely upon reasonable notification. This assistance shall not be construed to mean permanent working and therefore permanent attendance outside the supervising officer's normal working hours.

Contract Cost Rs. \_\_\_\_\_ (Pak Rupee \_\_\_\_\_ (In Words) \_\_\_\_\_)  
***inclusive of all Tax's, duties, levies except provincial sales tax (PST) / ICT where applicable, which shall be paid / borne by OGDCL as actual.*** The contractor undertakes that no claims on account of market fluctuation will be entertained during the term of the contract for any item of work included in the schedule of Quantities annexed. The contractor shall not request for escalation of rates throughout the term of contract.

**CONTRACT PERIOD:** - \_\_\_\_ Calendar days from date of the site possession.

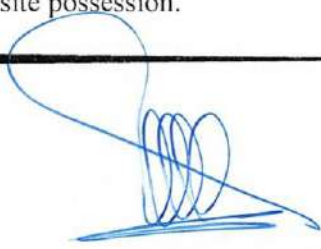
  
**Muhammad Muaz**  
C.E (P/Line)  
Ext: 5065





- 10. In case of default of the contractor and/or any of its sub contractors and/or any violation of the terms and conditions of the contract and the contract documents by the contractor and/or any of its contractors the work will be done at the risk & cost of the contractor as per Engineering Practice.
- 11. Contractor shall provide performance Bond in the shape of a pay order/Bank Guarantee from a Scheduled bank of Pakistan @ 10% of the bid Price.
- 12. The performance Bond shall remain valid from date of commencement till date of completion of work.
- 13. Anything not mentioned/clarified herein, in such eventuality the terms and conditions of the contract documents shall apply.

IN WITNESS whereof the parties hereto have caused their respective common seals to be hereunto affixed (or have hereunto set their respective hand and seals) the day and year first above written.

For and on behalf of OGDCL

Mr. \_\_\_\_\_  
Designation \_\_\_\_\_

For and on behalf of the Contractor

Mr. \_\_\_\_\_  
M/S \_\_\_\_\_

**In Present of Witnesses:-**

1. Mr. \_\_\_\_\_  
CNIC# \_\_\_\_\_

1. Mr. \_\_\_\_\_  
CNIC# \_\_\_\_\_

2. Mr. \_\_\_\_\_  
CNIC# \_\_\_\_\_

2. Mr. \_\_\_\_\_  
CNIC# \_\_\_\_\_

**Muhammad Muaz**  
C.E (P/Line)  
Ext: 5065

**MOBILIZATION ADVANCE GUARANTEE**

Guarantee No. \_\_\_\_\_  
Amount of Guarantee \_\_\_\_\_ Expiry  
date \_\_\_\_\_  
Beneficiary: OGDCL, Islamabad

WHEREAS The Oil & Gas Development Company Limited (OGDCL) (hereinafter called the 'Employer') has entered into a Contract for -----  
----- With M/S----- called  
the 'Contractor')

AND WHEREAS, the Employer has agreed to advance to the Contractor, at the Contractor's request, an amount of Rupees \_\_\_\_\_ (Rs in Words) which amount shall be advanced to the Contractor as per provisions of the Contract.

AND WHEREAS, the Employer has asked the Contractor to furnish Guarantee to fully secure the mobilization advance for the performance of his obligations under the said Contract.

AND WHEREAS, \_\_\_\_\_  
(Scheduled Bank in Pakistan acceptable to the Employer)  
(Hereinafter called the "Guarantor") at the request of the Contractor and in consideration of the Employer agreeing to make the above advance to the Contractor, has agreed to furnish the said Guarantee for the amount of .....(say.....) as security for the fulfillment by the Contractor of their obligations under the Contract and for the reimbursement of any damages which the Employer may suffer as a result of any failure on the part of the Contractor to fulfill their obligations under the contract.

NOW, THEREFORE, the Guarantor hereby guarantees that the Contractor shall use the advance for the purpose of above mentioned Contract and if he fails and commits default in fulfilment of any of his obligations for which the advance payment is made, the Guarantor shall be liable to the Employer for payment not exceeding the aforementioned amount.

Notice in writing of any default, of which the Employer shall be the sole and final judge, on the part of the Contractor, shall be given by the Employer to the Guarantor, and on such first written demand, payment shall be made by the Guarantor of all sums then due under this Guarantee without any reference to the Contractor and without any objection. This Guarantee shall remain in force until the advance is fully adjusted against payments from the Interim Payment Certificates of the

  
**Muhammad Muaz**  
C.E (P/Line)  
Ext: 5065



Contractor or until \_\_\_\_\_ whichever is earlier.

The Guarantor Bank hereby further declares and guarantees independently, unconditionally and irrevocably for immediate payment of full amount of advance payment upon Employer's **first and simple** written demand without making any reference, recourse to Contractor, account Party or any other person and without any question, query and contestation, in case the Contractor does not fulfill their obligations or in case the contract has been annulled, non-execution of the contract or cancellation of the contract or the contract cannot be executed because of Force Majeure or if the contract turns out to be void or unenforceable. Employer, in this regard, shall be the sole, absolute and final judge.

**MG-2**

The Guarantor's liability under this Guarantee shall not in any case exceed the sum of Rupees \_\_\_\_\_ (Rs \_\_\_\_\_). This Guarantee shall expire on \_\_\_\_\_ 20\_\_ hours Pakistan Time. Any request for payment under the terms of this guarantee must therefore be received by the Bank prior to this time.

For Guarantor Bank Seal

**Witness;**

**Manager:**

1. Name: \_\_\_\_\_

1. Authorized Signature \_\_\_\_\_

Title: \_\_\_\_\_

2. Name: \_\_\_\_\_

Address: \_\_\_\_\_

3. Title: \_\_\_\_\_

2. Name: \_\_\_\_\_

4. In the capacity of: \_\_\_\_\_

Title: \_\_\_\_\_

5. In the presence of: \_\_\_\_\_

Address: \_\_\_\_\_

  
**Muhammad Muaz**  
C.E (P/Line)  
Ext: 5065



**PART – I**  
**GENERAL CONDITIONS OF CONTRACT**

**PART – I****GENERAL CONDITIONS OF CONTRACT****Definitions and Interpretation****1.1 Definitions**

In the Contract (as hereinafter defined) the following words and expressions shall have the meanings hereby assigned to them, except where the context otherwise requires:

- (a) (i) "Employer" means Oil & Gas Development Company Limited (OGDCL), who will employ the Contractor and the legal successors in title to the Employer, but not except with the consent of the Contractor any assignee of the Employer.
- (ii) "Contractor" means the person or persons, firms, company or Joint Venture whose tender has been accepted by the Employer and includes the Contractor's personal representatives, successors and permitted assigns.
- (iii) "Subcontractor" means any person named in the Contract as a Subcontractor for a part of the Works or any person to whom a part of the Works has been subcontracted with the consent of the Engineer and the legal successors in title to such person, but not any assignee of any such person.
- (iv) "Engineer" means the person appointed by the Employer (in writing) to act as Engineer for the purposes of the Contract and named as such in Part II of these Conditions.
- (v) "Engineer's Representative" means a person appointed from time to time by the Engineer under Sub-Clause 2.2.
- (b) (i) "Contract" means these Conditions (Parts I and II), the Specification, the Drawings, the Bill of Quantities, the Tender, the Letter of Acceptance, the Contract and The performance Bond.
- (ii) "Specification" means the specification of the Works included in the Contract and any modification thereof or addition thereto made under Clause 51 or submitted by the Contractor and approved by the Engineer.
- (iii) "Drawings" means all drawings, calculations and technical information of a like nature provided by the designer / contractor under the Contract and all drawings, calculations, samples, patterns, models, operation and maintenance manuals and other technical information of a like nature submitted by the Contractor and approved in writing by the Employer.



- (iv) "Bill of Quantities" means the priced and completed bill of quantities forming part of the Tender.
- (v) "Tender" means the Contractor's priced offer to the Employer for the execution and completion of the Works and the remedying of any defects therein in accordance with the provisions of the Contract, as accepted by the Letter of Acceptance.
- (vi) "Letter of Acceptance" means the formal acceptance by the Employer of the Tender.
- (vii) "Contract" means the contract (if any) referred to in Sub-Clause 9.1.
- (viii) "Appendix to Tender" means the appendix comprised in the form of Tender annexed to these Conditions.
- (c) (i) "Commencement Date" means the date upon which the Contractor receives the notice to commence issued by the Engineer pursuant to Clause 41.
- (ii) "Time for Completion" means the time for completing the execution of and passing the Tests on Completion of the Works or any Section or part thereof as stated in the Contract (or as extended under Clause 44) calculated from the Commencement Date.
- (d) (i) "Tests on Completion" means the tests specified in the Contract or otherwise agreed by the Engineer and the Contractor which are to be made by the Contractor before the Works of any Section or part thereof are taken over by the Employer.
- (ii) "Taking-Over Certificate" means a certificate issued pursuant to Clause 48.
- (e) (i) "Contract Price" means the sum stated in the Letter of Acceptance as payable to the Contractor for the execution and completion of the Works and the remedying of any defects therein in accordance with the provisions of the Contract.
- (ii) "Retention Money" means the aggregate of all monies retained by the Employer pursuant to Sub-Clause 60.2(a).
- (iii) "Interim Payment Certificate" means any certificate of payment issued by the Engineer other than the Final Payment Certificate.
- (iv) "Final Payment Certificate" means the certificate of payment issued by the Engineer pursuant to Sub-Clause 60.8.



- (f) (i) "Works" means the Permanent Works and the Temporary Works or either of them as appropriate.
- (ii) "Permanent Works" means the permanent works to be executed (including Plant) and maintained in accordance with the Contract
- (iii) "Temporary Works" means all temporary works of every kind required in or about the execution and completion of the Works and the remedying of any defects therein.
- (iv) "Plant" means machinery, apparatus and the like intended to form or forming part of the Permanent Works.
- (v) "Contractor's Equipment" means all appliances and things of whatsoever nature (other than Temporary Works) required for the execution and completion of the Works and the remedying of any defects therein, but does not include Plant, materials or other things intended to form or forming part of the Permanent Works.
- (vi) "Section" means a part of the Works specifically identified in the Contract as a Section.
- (vii) "Site" means the places provided by the Employer where the Works are to be executed and any other places as may be specifically designated in the Contract as forming part of the Site.
- (g) (i) "cost" means all expenditure properly incurred or to be incurred, whether, on or off the Site, including overhead and other charges properly allocable thereto but does not include any allowance for profit.
- (ii) "day" means calendar day.
- (iii) "foreign currency" means a currency of a country other than that in which the Works are to be located.
- (iv) "writing" means any hand-written, type-written, or printed communication, including telex, cable and facsimile transmission.

## 1.2 Headings and Marginal Notes

The headings and marginal notes in these Conditions of Contract shall not be deemed to be part thereof or be taken into consideration in the interpretation or construction thereof or of the Contract.

## 1.3 Interpretation

Words importing persons or parties shall include firms and corporations and any organization having legal capacity.



#### 1.4 Singular and Plural

Words importing the singular only also include the plural and vice versa where the context requires.

#### 1.5 Notices, Consents, Approvals, Certificates and Determinations

Wherever in the Contract provision is made for the giving or issue of any notice, consent, approval, certificate or determination by any person, unless otherwise specified such notice, consent, approval, certificate or determination shall be in writing and the words "notify", "certify" or "determine" shall be construed accordingly. Any such consent, approval, certificate or determination shall not unreasonably be withheld or delayed.

### Engineer and Engineer's Representative

#### 2.1 Engineer's Duties and Authority

- (a) The Engineer shall carry out the duties specified in the Contract.
- (b) The Engineer may exercise the authority specified in or necessarily to be implied from the Contract, provided, however, that if the Engineer is required, under the terms of his appointment by the Employer, to obtain the specific approval of the Employer before exercising any such authority, particulars of such requirements shall be set out in Part II of these Conditions. Provided further that any requisite approval shall be deemed to have been given by the Employer for any such authority exercised by the Engineer.
- (c) Except as expressly stated in the Contract, the Engineer shall have no authority to relieve the Contractor of any of his obligations under the Contract.

#### 2.2 Engineer's Representative

The Engineer's Representative shall be appointed by and be responsible to the Engineer and shall carry out such duties and exercise such authority as may be delegated to him by the Engineer under Sub-Clause 2.3.

#### 2.3 Engineer's Authority to Delegate

The Engineer may from time to time delegate to the Engineer's Representative any of the duties and authorities vested in the Engineer and he may at any time revoke such delegation. Any such delegation or revocation shall be in writing and shall not take effect until a copy thereof has been delivered to the Employer and the Contractor.

Any communication given by the Engineer's Representative to the Contractor in accordance with such delegation shall have the same effect as though it had been given by the Engineer. Provided that:

- (a) any failure of the Engineer's Representative to disapprove any work, materials or





Plant shall not prejudice the authority of the Engineer to disapprove such work, materials or Plant and to give instructions for the rectification thereof; and

- (b) if the Contractor questions any communication of the Engineer's Representative he may refer the matter to the Engineer who shall confirm, reverse or vary the contents of such communication.

#### 2.4 **Appointment of Assistants**

The Engineer or the Engineer's Representative may appoint any number of persons to assist the Engineer's Representative in the carrying out of his duties under Sub-Clause 2.2. He shall notify to the Contractor the names, duties and scope of authority of such persons. Such assistants shall have no authority to issue any instructions to the Contractor save in so far as such instructions may be necessary to enable them to carry out their duties and to secure their acceptance of materials, Plant or workmanship as being in accordance with the Contract, and any instructions given by any of them for those purposes shall be deemed to have been given by the Engineer's Representative.

#### 2.5 **Instructions in Writing**

Instructions given by the Engineer shall be in writing, provided that if for any reason the Engineer considers it necessary to give any such instruction orally, the Contractor shall comply with such instruction. Confirmation in writing of such oral instruction given by the Engineer, whether before or after the carrying out of the instruction, shall be deemed to be an instruction within the meaning of this Sub-Clause. Provided further that if the Contractor, within 7 days, confirms in writing to the Engineer any oral instruction of the Engineer and such confirmation is not contradicted in writing within 7 days by the Engineer, it shall be deemed to be an instructions of the Engineer.

The provisions of this Sub-Clause shall equally apply to instructions given by the Engineer's Representative and any assistants of the Engineer or the Engineer's Representative appointed pursuant to Sub-Clause 2.4.

#### 2.6 **Engineer to Act Impartially**

Wherever, under the Contract, the Engineer is required to exercise his discretion by:

- (a) giving his decision, opinion or consent,
- (b) expressing his satisfaction or approval,
- (c) determining value, or
- (d) otherwise taking action which may affect the rights and obligations of the Employer or the Contractor

he shall exercise such discretion impartially and fairly within the terms of the Contract and having regard to all the circumstances. Any such decision, opinion, consent expression of satisfaction, or approval, determination of value or action may be opened up, reviewed or revised as provided in Clause 67.

#### **Assignment and Subcontracting**



### 3.1 Assignment of Contract

The Contractor shall not, without the prior written consent of the Employer (which consent, notwithstanding the provisions of Sub-Clause 1.5, shall be at the sole discretion of the Employer), assign the Contract or any part thereof, or any benefit or interest therein or thereunder, otherwise than by:

- (a) a charge in favour of the Contractor's bankers of any monies due or to become due under the Contract, or
- (b) assignment to the Contractor's insurers (in cases where the insurers have discharged the Contractor's loss or liability) of the Contractor's right to obtain relief against any other party liable.

### 4.1 Subcontracting

The Contractor shall not subcontract the whole of the Works. Except where otherwise provided by the Contract, the Contractor shall not subcontract any part of the Works without the prior consent of the Engineer. Any such consent shall not relieve the Contractor from any liability or obligation under the Contract and he shall be responsible for the acts, defaults and neglects of any Subcontractor, his agents, servants or workmen as fully as if they were the acts, defaults or neglects of the Contractor, his agent's servants or workmen.

Provided that the Contractor shall not be required to obtain such consent for:

- (a) the provision of Labour,
- (b) the purchase of materials which are in accordance with the standards specified in the Contract,
- (c) the subcontracting of any part of the Works for which the Subcontractor is named in the Contract.

### 4.2 Assignment of Subcontractors' Obligations

In the event of a Subcontractor having undertaken towards the Contractor in respect of the work executed, or the goods, materials, Plant or services supplied by such Subcontractor, any continuing obligation extending for a period exceeding that of the Defects Liability Period under the Contract, the Contractor shall at any time, after the expiration of such Period, assign to the Employer, at the Employer's request and cost, the benefit of such obligation for the unexpired duration thereof.



### Contract Documents

#### 5.1 Language/s and Law

There is stated in Part II of these Conditions:

- (a) the language or languages in which the Contract documents shall be drawn up, and
- (b) the country or state the law of which shall apply to the Contract and according to which the Contract shall be construed.

If the said documents are written in more than one language, the language according to which the Contract shall be construed and interpreted is also stated in Part II of these Conditions, being therein designated the "Ruling Language".

#### 5.2 Priority of Contract Documents

The several documents forming the Contract are to be taken as mutually explanatory of one another, but in case of ambiguities or discrepancies the same shall be explained and adjusted by the Engineer who shall thereupon issue to the Contractor instructions thereon and in such event, unless otherwise provided in the Contract, the priority of the documents forming the Contract shall be as follows:

- (1) The Contract (if completed);
- (2) The Letter of Acceptance;
- (3) The Tender;
- (4) Part II of these Conditions;
- (5) Part I of these Conditions; and
- (6) Any other document forming part of the Contract.

#### 6.1 Custody and Supply of Drawings and Documents

The Drawings shall remain in the sole custody of the Engineer, but two copies thereof shall be provided to the Contractor free of charge. The Contractor shall make at his own cost any further copies required by him. Unless it is strictly necessary for the purposes of the Contract, the Drawings, Specification and other documents provided by the Employer or the Engineer shall not, without the consent of the Engineer, be used or communicated to a third party by the Contractor. Upon issue of the Defects Liability Certificate, the Contractor shall return to the Engineer all Drawings, Specification and other documents provided under the Contract.

The Contractor shall supply to the Engineer four copies of all Drawings, specification and other documents submitted by the Contractor and approved by the Engineer in accordance with Clause 7, together with a reproducible copy of any material which cannot be reproduced to an equal standard by photocopying. In addition the Contractor shall supply such further copies of such Drawings, Specification and other



documents as the Engineer may request in writing for the use of the Employer, who shall pay the cost thereof.

#### 6.2 **One Copy of Drawings to be kept on Site**

One copy of the Drawings, provided to or supplied by the Contractor as aforesaid, shall be kept by the Contractor on the Site and the same shall at all reasonable times be available for inspection and use by the Engineer and by any other person authorized by the Engineer in writing.

#### 6.3 **Disruption of Progress**

The Contractor shall give notice to the Engineer, with a copy to the Employer, whenever planning or execution of the Works is likely to be delayed or disrupted unless any further drawing or instruction is issued by the Engineer within a reasonable time. The notice shall include details of the drawing or instruction required and of why and by when it is required and of any delay or disruption likely to be suffered if it is late.

#### 6.4 **Delay and Cost of Delay of Drawings**

If, by reason of any failure or inability of the Engineer to issue, within a time reasonable in all the circumstances, any drawing or instruction for which notice has been given by the Contractor in accordance with Sub-Clause 6.3, the Contractor suffers delay and/or incurs costs then the Engineer shall, after due consultation with the Employer and the Contractor, determine:

- (a) any extension of time to which the Contractor is entitled under Clause 44, and
- (b) the amount of such costs, which shall be added to the Contract Price, and shall notify the Contractor accordingly, with a copy to the Employer.

#### 6.5 **Failure by Contractor to Submit Drawings**

If the failure or inability of the Engineer to issue any drawings or instructions is caused in whole or in part by the failure of the Contractor to submit Drawings, Specification or other documents which he is required to submit under the Contract, the Engineer shall take such failure by the Contractor into account when making his determination pursuant to Sub-Clause 6.4.

#### 7.1 **Supplementary Drawings and Instructions**

The Engineer shall have authority to issue to the Contractor, from time to time, such supplementary Drawings and instructions as shall be necessary for the purpose of the proper and adequate execution and completion of the Works and the remedying of any defects therein. The Contractor shall carry out and be bound by the same.

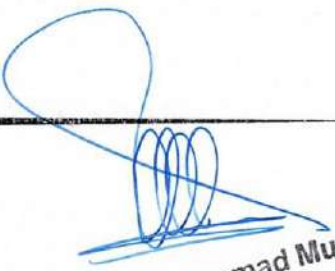

**Muhammad Muaz**  
C.E (P/Line)  
Ext: 5065



## 7.2 Permanent Works Designed by Contractor

Where the Contract expressly provides that part of the Permanent Works shall be designed by the Contractor, he shall submit to the Engineer, for approval:

- (a) such drawings, specifications, calculations and other information as shall be necessary to satisfy the Engineer as to the suitability and adequacy of that design, and
- (b) operation and maintenance manuals together with drawings of the Permanent Works as completed, in sufficient detail to enable the Employer to operate, maintain, dismantle, reassemble and adjust the Permanent Works incorporating that design. The Works shall not be considered to be completed for the purposes of taking over in accordance with Clause 48 until such operation and maintenance manuals together with drawings on completion have been submitted to and approved by the Engineer.

## 7.3 Responsibility Unaffected by Approval

Approval by the Engineer, in accordance with Sub-Clause 7.2, shall not relieve the Contractor of any of his responsibilities under the Contract.

### General Obligations

## 8.1 Contractor's General Responsibilities

The Contractor shall always act and perform, with due care and diligence, design (to the extent provided for by the Contract), execute and complete the Works and remedy any defects therein in accordance with the provisions of the Contract. The Contractor shall provide all super-intendance, labour, material, Plant, Contractor's Equipment and all other things, whether of a temporary or permanent nature, required in and for such design, execution, completion and remedying of any defects, so far as the necessity for providing the same is specified in or is reasonably to be inferred from the Contract.

## 8.2 Site Operations and Methods of Construction

The Contractor shall take full responsibility for the adequacy, stability and safety of all Site operations and methods of construction. Provided that the Contractor shall not be responsible (except as stated hereunder or as may be otherwise agreed) for the design or specification of Permanent Works, or for the design or specification of any Temporary Works not prepared by the Contractor. Where the Contract expressly provides that part of the Permanent Works shall be designed by the Contractor, he shall be fully responsible for that part of such Works, notwithstanding any approval by the Engineer.



## 9.1 Contract

The Contractor shall, if called upon so to do, enter into and execute the Contract Agreement, to be prepared and completed at the cost of the Employer, in the form annexed to these Conditions with such modification as may be necessary.

## 10.1 Performance Guarantee

If the Contract requires the Contractor to obtain Performance Guarantee in the shape of Bank Guarantee for his proper performance of the Contract, he shall obtain and provide to the Employer, such guarantee within 14 days after the receipt of the Letter of Acceptance, in the sum stated in the Appendix to Tender. Such guarantee shall be in the form annexed to these Conditions or on the Employer Format. The institution providing such security shall be subject to the approval of the Employer. The cost of complying with the requirements of this Clause shall be borne by the Contractor, unless the Contract otherwise provides.

## 10.2 Period of Validity of Performance Guarantee

The performance guarantee shall be valid until the Contractor has executed and completed the Works and remedied any defects therein in accordance with the Contract. Such guarantee shall be returned to the Contractor after 14 days of the issuance of Final Completion Certificate by the Employer.

## 10.3 Claims under Performance Guarantee

Prior to making a claim under the performance guarantee the Employer shall in every case, notify the Contractor stating the nature of the default in respect of which the claim is to be made.

## 11.1 Inspection of Site

The Employer shall have made available to the Contractor, before the submission by the Contractor of the Tender, such data on hydrological and sub-surface conditions as have been obtained by or on behalf of the Employer from investigations undertaken relevant to the Works but the Contractor shall be responsible for his own interpretation thereof.

The Contractor shall be deemed to have inspected and examined the Site and its surroundings and information available in connection therewith and to have satisfied himself (so far as is practicable, having regard to considerations of cost and time) before submitting his Tender, as to:

- (a) the form and nature thereof, including the sub-surface conditions,
- (b) the hydrological and climatic conditions,
- (c) the extent and nature of work and materials necessary for the execution and completion of the Works and the remedying of any defects therein, and



- (d) the means of access to the Site and the accommodation he may require, and, in general, shall be deemed to have obtained all necessary information, subject as above mentioned, as to risks, contingencies and all other circumstances which may influence or affect his Tender.

The Contractor shall be deemed to have based his Tender on the data made available by the Employer and on his own inspection and examination, all as aforementioned.

#### 12.1 Sufficiency of Tender

The Contractor shall be deemed to have satisfied himself as to the correctness and sufficiency of the Tender and of the rates and prices stated in the Bill of Quantities, all of which shall, except insofar as it is otherwise provided in the Contract, cover all his obligations under the Contract (including those in respect of the supply of goods, materials, Plant or services or of contingencies for which there is a Provisional Sum) and all matters and things necessary for the proper execution and completion of the Works and the remedying of any defects therein.

#### 12.2 Not Foreseeable Physical Obstructions or Conditions

If, however, during the execution of the Works the Contractor encounters physical obstructions or physical conditions, other than climatic conditions on the Site, which obstructions or conditions were, in his opinion, not foreseeable by an experienced contractor, the Contractor shall forthwith give notice thereof to the Engineer, with a copy to the Employer. On receipt of such notice, the Engineer shall if in his opinion such obstructions or conditions could not have been reasonably foreseen by an experienced contractor, after due consultation with the Employer and the Contractor, determine:

- (a) any extension of time to which the Contractor is entitled under Clause 44, and  
(b) the amount of any costs which may have been incurred by the Contractor by reason of such obstructions or conditions having been encountered, which shall be added to the Contract Price,

and shall notify the Contractor accordingly, with a copy to the Employer. Such determination shall take account of any instruction which the Engineer may issue to the Contractor in connection therewith, and any proper and reasonable measures acceptable to the Engineer which the Contractor may take in the absence of specific instructions from the Engineer.

#### 13.1 Work to be in Accordance with Contract

Unless it is legally or physically impossible, the Contractor shall execute and complete the Works and remedy any defects therein in strict accordance with the Contract to the satisfaction of the Engineer. The Contractor shall comply with and adhere strictly to the Engineer's instructions on any matter, whether mentioned in the Contract or not, touching or concerning the Works. The Contractor shall take



instructions only from the Engineer (or his delegate).

#### 14.1 Programme to be Submitted

The Contractor shall, within the time stated in Part II of these Conditions after the date of the Letter of Acceptance, submit to the Engineer for his consent a programme, in such form and detail as the Engineer shall reasonably prescribe, for the execution of the Works. The Contractor shall, whenever required by the Engineer, also provide in writing for his information a general description of the arrangements and methods which the Contractor proposes to adopt for the execution of the Works.

#### 14.2 Revised Programme

If at any time it should appear to the Engineer that the actual progress of the Works does not conform to the programme to which consent has been given under Sub-Clause 14.1, the Contractor shall produce, at the request of the Engineer, a revised programme showing the modifications to such programme necessary to ensure completion of the Works within the Time for Completion.

#### 14.3 Cash Flow Estimate to be submitted

The Contractor shall, within the time stated in Part II of these Conditions after the date of the Letter of Acceptance, provide to the Engineer for his information a detailed cash flow estimate, in quarterly periods, of all payments to which the Contractor will be entitled under the Contract and the Contractor shall subsequently supply revised cash flow estimates at quarterly intervals, if required to do so by the Engineer.

#### 14.4 Contractor not Relieved of Duties or Responsibilities

The submission to and consent by the Engineer of such programme or the provision of such general descriptions or cash flow estimates shall not relieve the Contractor of any of his duties or responsibilities under the Contract.

#### 15.1 Contractor's Superintendence

The Contractor shall provide all necessary superintendence during the execution of the Works and as long thereafter as the Engineer may consider necessary for the proper fulfilling of the Contractor's obligations under the Contract. The Contractor, or a competent and authorized representative approved of by the Engineer, which approval may at any time be withdrawn, shall give his whole time to the superintendence of the Works. Such authorized representative shall receive, on behalf of the Contractor, instructions from the Engineer.

If approval of the representative is withdrawn by the Engineer, the Contractor shall, as soon as is practicable, having regard to the requirement of replacing him as hereinafter mentioned, after receiving notice of such withdrawal, remove the representative from the Works and shall not thereafter employ him again on the Works in any capacity and shall replace him by another representative approved by





the Engineer.

#### 16.1 Contractor's Employees

The Contractor shall provide on the Site in connection with the execution and completion of the Works and the remedying of any defects therein:

- (a) only such technical assistants as are skilled and experienced in their respective callings and such foremen and leading hands as are competent to give proper superintendence of the Works, and
- (b) such skilled, semi skilled and unskilled labour as is necessary for the proper and timely fulfilling of the Contractor's obligations under the Contract.

#### 16.2 Engineers at Liberty to Object

The Engineer shall be at liberty to object to and require the Contractor to remove forthwith from the Works any person provided by the Contractor who, in the opinion of the Engineer, misconducts himself, or is incompetent or negligent in the proper performance of his duties, or whose presence on Site is otherwise considered by the Engineer to be undesirable or security risk, and such person shall not be again allowed upon the Works without the consent of the Engineer. Any person so removed from the Works shall be replaced as soon as possible.

#### 17.1 Setting-out

The Contractor shall be responsible for:

- (a) the accurate setting-out of the Works in relation to original points, lines and levels of reference given by the Engineer in writing,
- (b) the correctness, subject as above mentioned of the position, levels dimensions and alignment of all parts of the Works, and
- (c) the provision of all necessary instruments, appliances and labour in connection with the foregoing responsibilities.

If, at any time during the execution of the Works, any error appears in the position, levels, dimensions or alignment of any part of the Works, the Contractor, on being required so to do by the Engineer, shall, at his own cost, rectify such error to the satisfaction of the Engineer, unless such error is based on incorrect data supplied in writing by the Engineer, in which case the Engineer shall determine an addition to the Contract Price in accordance with Clause 52 and shall notify the Contractor accordingly, with a copy to the Employer.

The checking of any setting-out or of any line or level by the Engineer shall not in any way relieve the Contractor of his responsibility for the accuracy thereof and the Contractor shall carefully protect and preserve all bench-marks, sight-rails, pegs and other things used in setting-out the Works.



### 18.1 Boreholes and Exploratory Excavation

If, at any time during the execution of the Works, the Engineer requires the Contractor to make boreholes or to carry out exploratory excavation, such requirement shall be the subject of an instruction in accordance with Clause 51, unless an item or a Provisional Sum in respect of such work is included in the Bill of Quantities.

### 19.1 Safety, Security and Protection of the Environment

The Contractor shall, throughout the execution and completion of the Works and the remedying of any defects therein:

- (a) have full regard for the safety of all persons entitled to be upon the Site and keep the Site (so far as the same is under his control) and the Works (so far as the same are not completed or occupied by the Employer) in an orderly state appropriate to the avoidance of danger to such persons,
- (b) provide and maintain at his own cost all lights, guards, fencing, warning signs and watching, when and where necessary or required by the Engineer or by any duly constituted authority, for the protection of the Works or for the safety and convenience of the public or others, and
- (c) take all reasonable steps to protect the environment on and off the Site and to avoid damage or nuisance to persons or to property of the public or others resulting from pollution, noise or other causes arising as a consequence of his methods of operation.

### 19.2 Employer's Responsibilities

If under Clause 31 the Employer shall carry out work on the Site with his own workmen he shall, in respect of such work:

- (a) have full regard to the safety of all persons entitled to be upon the Site, and
- (b) keep the Site in an orderly state appropriate to the avoidance of danger to such persons.

If under Clause 31 the Employer shall employ other contractors on the Site he shall require them to have the same regard for safety and avoidance of danger.

### 20.1 Care of Works

The Contractor shall take full responsibility for the care of the Works and materials and Plant for incorporation therein from the Commencement Date until the date of issue of the Taking-Over Certificate for the whole of the Works, when the responsibility for the said care shall pass to the Employer. Provided that:



- (a) if the Engineer issues a Taking-Over Certificate for any Section or part of the Permanent Works the Contractor shall cease to be liable for the care of that Section or part from the date of issue of the Taking-Over Certificate, when the responsibility for the care of that Section or part shall pass to the Employer, and
- (b) the Contractor shall take full responsibility for the care of any outstanding Works and materials and Plant for incorporation therein which he undertakes to finish during the Defects Liability Period until such outstanding Works have been completed pursuant to Clause 49.

#### 20.2 Responsibility to Rectify Loss or Damage

If any loss or damage happens to the Works, or any part thereof, or materials or Plant for incorporation therein, during the period for which the Contractor is responsible for the care thereof, from any cause whatsoever, other than the risks defined in Sub-Clause 20.4, the Contractor shall, at his own cost, rectify such loss or damage so that the Permanent Works conform in every respect with the provisions of the Contract to the satisfaction of the Engineer. The Contractor shall also be liable for any loss or damage to the Works occasioned by him in the course of any operations carried out by him for the purpose of complying with his obligations under Clauses 49 and 50.

#### 20.3 Loss or Damage Due to Employer's Risks

In the event of any such loss or damage happening from any of the risks defined in Sub-Clause 20.4, or in combination with other risks, the Contractor shall, if and to the extent required by the Engineer, rectify the loss or damage and the Engineer shall determine an addition to the Contract Price in accordance with Clause 52 and shall notify the Contractor accordingly, with a copy to the Employer. In the case of a combination or risks causing loss or damage any such determination shall take into account the proportional responsibility of the Contractor and the Employer.

#### 20.4 Employer's Risks

The Employer's risks are:

- (a) war, hostilities (whether war be declared or not), invasion, act of foreign enemies,
- (b) Rebellion, revolution, insurrection, or military or usurped power, or civil war,
- (c) ionising radiations, or contamination by radio-activity from any nuclear fuel, or from any nuclear waste from the combustion of nuclear fuel, radio-active toxic explosive, or other hazardous properties of any explosive nuclear assembly or nuclear component thereof,
- (d) pressure waves caused by aircraft or other aerial devices travelling at sonic or supersonic speeds,



- (e) riot, commotion or disorder, unless solely restricted to employees of the Contractor or of his Subcontractor and arising from the conduct of the Works,
- (f) loss or damage due to the use or occupation by the Employer of any Section or part of the Permanent Works, except as may be provided for in the Contract,
- (g) loss or damage to the extent that it is due to the design of the Works, other than any part of the design provided by the Contractor or for which the Contractor is responsible, and
- (h) any operation of the forces of nature against which an experienced contractor could not reasonably have been expected to take precautions.

**21.1 Insurance of Works and Contractor's Equipment**

The Contractor shall, without limiting his or the Employer's obligations and responsibilities under Clause 20, insure:

- (a) the Works, together with materials and Plant for incorporation therein, to the full replacement cost (the term "cost" in this context shall include profit),
- (b) an additional sum of 15 per cent of such replacement cost, or as may be specified in Part II of these Conditions, to cover any additional costs of and incidental to the rectification of loss or damage including professional fees and the cost of demolishing and removing any part of the Works and of removing debris of whatsoever nature, and
- (c) the Contractor's Equipment and other things brought onto the Site by the Contractor, for a sum sufficient to provide for their replacement at the Site.

**21.2 Scope of Cover**

The insurance in paragraphs (a) and (b) of Sub-Clause 21.1 shall be in the joint names of the Contractor and the Employer and shall cover:

- (a) the Employer and the Contractor against all loss or damage from whatsoever cause arising, other than as provided in Sub-Clause 21.4, from the start of work at the Site until the date of issue of the relevant Taking-Over Certificate in respect of the Works or any Section or part thereof as the case may be, and
- (b) the Contractor for his liability:
  - (i) during the Defects Liability Period for loss or damage arising from a cause occurring prior to the commencement of the Defects Liability Periods, and
  - (ii) for loss or damage occasioned by the Contractor in the course of any operations carried out by him for the purpose of complying with his obligations under Clauses 49 and 50.

  
**Muhammad Mueez**  
C.E (P/Line)  
Ext: 5065



**21.3 Responsibility for Amounts not recovered**

Any amounts not insured or not recovered from the insurers shall be borne by the Employer or the Contractor in accordance with their responsibilities under Clause 20.

**21.4 Exclusions**

There shall be no obligation for the insurances in Sub-Clause 21.1 to include loss or damage caused by:

- (a) war, hostilities (where war be declared or not), invasion, act of foreign enemies,
- (b) rebellion, revolution, insurrection, or military or usurped power, or civil war,
- (c) ionising, radiations, or contamination by radio-activity from any nuclear fuel, or from any nuclear waste from the combustion of nuclear fuel, radio-active toxic explosive or other hazardous properties of any explosive nuclear assembly or nuclear component thereof, or
- (d) pressure waves caused by aircraft or other aerial devices travelling at sonic or supersonic speeds.

**22.1 Damage to Persons and Property**

The Contractor shall, except if and so far as the Contract provides otherwise, indemnify the Employer against all losses and claims in respect of:

- (a) death of or injury to any person, or
- (b) loss of or damage to any property (other than the Works),

which may arise out of or in consequence of the execution and completion of the Works and the remedying of any defects therein, and against all claims, proceedings, damages, costs, charges and expenses whatsoever in respect thereof or in relation thereto, subject to the exceptions defined in Sub-Clause 22.2.

**22.2 Exceptions**

The "exceptions" referred to in Sub-Clause 22.1 are:

- (a) the permanent use or occupation of land by the Works, or any part thereof,
- (b) the right of the Employer to execute the Works, or any part thereof, on, over, under, is or through any land,
- (c) damage to property which is the unavoidable result of the execution and completion of the Works, or the remedying of any defects therein, in accordance with the Contract, and
- (d) death of or injury to persons or loss of or damage to property resulting from any



act or neglect of the Employer, his agents servants or other contractors, not being employed by the Contractor, or in respect of any claims, proceedings, damages, costs, charges and expenses in respect thereof or in relation thereto or, where the injury or damage was contributed to by the Contractor, his servants or agents, such part of the said injury or damage as may be just and equitable having regard to the extent of the responsibility of the Employer, his servants or agents or other contractors for the injury or damage.

### 22.3 **Indemnity by Employer**

The Employer shall indemnify the Contractor against all claims, proceedings, damages, costs, charges and expenses in respect of the matters referred to in the exceptions defined in Sub-Clause 22.2

### 23.1 **Third Party Insurance (including Employer's Property)**

The Contractor shall, without limiting his or the Employer's obligation and responsibilities under Clause 22, insure, in the joint names of the Contractor and the Employer, against liabilities for death of or injury to any person (other than as provided in Clause 24) or loss of or damage to any property (other than the Works) arising out of the performance of the Contract, other than the exceptions defined in paragraphs (a), (b) and (c) of Sub-Clause 22.2.

### 23.2 **Minimum Amount of Insurance**

Such insurance shall be for at least the amount stated in the Appendix to Tender.

### 23.3 **Cross Liabilities**

The insurance policy shall include a cross liability clause such that the insurance shall apply to the Contractor and to the Employer as separate insured's.

### 24.1 **Accident or Injury to Workmen**

The Employer shall not be liable for or in respect of any damages or compensation payable to any workman or other person in the employment of the Contractor or any Subcontractor, other than death or injury resulting from any act or default of the Employer, his agents or servants. The Contractor shall indemnify and keep indemnified the Employer against all such damages and compensation, other than those for which the Employer is liable as aforesaid, and against all claims, proceedings, damages, costs, charges, and expenses whatsoever in respect thereof or in relation thereto.

### 24.2 **Insurance Against Accidents, etc. to Workmen**

The Contractor shall insure against such liability and shall continue such insurance during the whole of the time that any persons are employed by him on the Works. Provided that, in respect of any persons employed by any Subcontractor, the



Contractor's obligations to insure as aforesaid under the Sub-Clause shall be satisfied if the Subcontractor shall have insured against the liability in respect of such persons in such manner that the Employer is indemnified under the policy, but the Contractor shall require such Subcontractor to produce to the Employer, when required, such policy of insurance and the receipt for the payment of the current premium.

**25.1 Evidence and Terms of Insurances**

The Contractor shall provide evidence to the Employer prior to the start of work at the Site that the insurances required under the Contract have been effected and shall, within 84 days of the Commencement Date, provide the insurance policies to the Employer. When providing such evidence and such policies to the Employer, the Contractor shall notify the Engineer of so doing. Such insurance policies shall be consistent with the general terms agreed prior to the issue of the Letter of Acceptance. The Contractor shall effect all insurances for which he is responsible with insurers

**25.2 Adequacy of Insurances**

The Contractor shall notify the insurers of changes in the nature, extent or programme for the execution of the Works and ensure the adequacy of the insurances at all times in accordance with the terms of the Contract and shall, when required, produce to the Employer the insurance policies in force and the receipts for payment of the current premiums.

**25.3 Remedy on Contractor's Failure to Insure**

If the Contractor fails to effect and keep in force any of the insurances required under the Contract, or fails to provide the policies to the Employer within the period required by Sub-Clause 25.1, then and in any such case the Employer may effect and keep in force any such insurances and pay any premium as may be necessary for that purpose and from time to time deduct the amount so paid from any monies due or to become due to the Contractor, or recover the same as a debt due from the Contractor.

**25.4 Compliance with Policy Conditions**

In the event that the Contractor or the Employer fails to comply with conditions imposed by the insurance policies effected pursuant to the Contract, each shall indemnify the other against all losses and claims arising from such failure.



## 26.1 Compliance with Statutes, Regulations

The Contractor shall conform in all respects, including by the giving of all notices and the paying of all fees, with the provisions of:

- (a) any National or State Statute, Ordinance, or other Law, or any regulation, or by-law of any local or other duly constituted authority in relation to the execution and completion of the Works and the remedying of any defects therein, and
- (b) the rules and regulations of all public bodies and companies whose property or rights are affected or may be affected in any way by the Works,

and the Contractor shall keep the Employer indemnified against all penalties and liability of every kind for breach of any such provisions. Provided always that the Employer shall be responsible for obtaining any planning, zoning or other similar permission required for the Works to proceed and shall indemnify the Contractor in accordance with Sub-Clause 22.3.

## 27.1 Fossils, etc.

All fossils, coins, articles of value or antiquity and structures and other remains or things of geological or archaeological interest discovered on the Site shall, as between the Employer and the Contractor, be deemed to be the absolute property of the Employer. The Contractor shall take reasonable precautions to prevent his workmen or any other persons from removing or damaging any such article or thing and shall, immediately upon discovery thereof and before removal, acquaint the Engineer of such discovery and carry out the Engineer's instructions for dealing with the same. If, by reason of such instructions, the Contractor suffers delay and/or incurs costs then the Engineer shall, after due consultation with the Employer and the Contractor, determine:

- (a) any extension of time to which the Contractor is entitled under Clause 44, and
- (b) the amount of such costs, which shall be added to the Contract Price, and shall notify the Contractor accordingly, with a copy to the Employer.

## 28.1 Patent Rights

The Contractor shall save harmless and indemnify the Employer from and against all claims and proceedings for or on account of infringement of any patent rights, design trademark or name or other protected rights in respect of any Contractor's Equipment, materials or Plant used for or in connection with or for incorporation in the Works and from and against all damages, costs, charges and expenses whatsoever in respect thereof or in relation thereto, except where such infringement results from compliance with the design or Specification provided by the Engineer.



**28.2 Royalties**

Except where otherwise stated, the Contractor shall pay all tonnage and other royalties, rent and other payments or compensation, if any, for getting stone, sand, gravel, clay or other materials required for the Works.

**29.1 Interference with Traffic and Adjoining Properties**

All operations necessary for the execution and completion of the Works and the remedying of any defects therein shall, so far as compliance with the requirements of the Contract permits, be carried on so as not to interfere unnecessarily or improperly with:

- (a) the convenience of the public, or
- (b) the access to, use and occupation of public or private roads and footpaths to or of properties whether in the possession of the Employer or of any other person.

The Contractor shall save harmless and indemnify the Employer in respect of all claims, proceedings, damages, costs, charges and expenses whatsoever arising out of, or in relation to, any such matters insofar as the Contractor is responsible therefore.

**30.1 Avoidance of Damage to Roads**

The Contractor shall use and adopt every reasonable means and measures to prevent private and public property or any of the roads or bridges communicating with or on the routes to the Site from being damaged or injured by any traffic of the Contractor or any of his Subcontractors and, in particular, shall select routes, choose and use vehicles and restrict and distribute loads so that any such extraordinary traffic as will inevitably arise from the moving of materials, Plant, Contractor's Equipment or Temporary Works from and to the Site shall be limited, as far as reasonably possible, and so that no unnecessary damage or injury may be occasioned to such roads and bridges.

**30.2 Transport of Contractor's Equipment or Temporary Works**

Save insofar as the Contract otherwise provides, the Contractor shall be responsible for and shall pay the cost of strengthening any bridges or altering or improving any road communicating with or on the routes to the Site to facilitate the movement of Contractor's Equipment or Temporary Works and the Contractor shall indemnify and keep indemnified the Employer against all claims for damage to any such road or bridge caused by such movement, including such claims as may be made directly against the Employer, and shall negotiate and pay all claims arising solely out of such damage.

**30.3 Transport of Materials or Plant**

If, notwithstanding Sub-Clause 30.1, any damage occurs to any bridge or road communicating with or on the routes to the Site arising from the transport of materials



or Plant, the Contractor shall notify the Engineer with a copy to the Employer, as soon as he becomes aware of such damage or as soon as he receives any claim from the authority entitled to make such claim. Where under any law or regulation the hauler of such materials or Plant is required to indemnify the road authority against damage the Employer shall not be liable for any costs, charges or expenses in respect thereof or in relation thereto. In other cases the Employer shall negotiate the settlement of and pay all sums due in respect of such claim and shall indemnify the Contractor in respect thereof and in respect of all claims, proceedings damages, costs, charges and expenses in relation thereto. Provided that if and so far as any such claim or part thereof is, in the opinion of the Engineer, due to any failure on the part of the Contractor to observe and perform his obligations under Sub-Clause 30.1, then the amount determined by the Engineer, after due consultation with the Employer and the Contractor, to be due to such failure shall be recoverable from the Contractor by the Employer and may be deducted by the Employer from any monies due or to become due to the Contractor and the Engineer shall notify the Contractor accordingly, with a copy to the Employer. Provided also that the Employer shall notify the Contractor whenever a settlement is to be negotiated and, where any amount may be due from the Contractor, the Employer shall consult with the Contractor before such settlement is agreed.

#### 30.4 **Waterborne Traffic**

Where the nature of the Works is such as to require the use by the Contractor of waterborne transport the foregoing provisions of this Clause shall be construed as though "road" included a lock, dock, sea wall or other structure related to a waterway and "vehicle" included craft, and shall have effect accordingly.

#### 31.1 **Opportunities for Other Contractors**

The Contractor shall, in accordance with the requirements of the Engineer, afford all reasonable opportunities for carrying out their work to:

- (a) any other contractors employed by the Employer and their workmen,
- (b) the workmen of the Employer, and
- (c) the workmen of any duly constituted authorities who may be employed in the execution on or near the Site of any work not included in the Contract or of any contract which the Employer may enter into in connection with or ancillary to the Works.

#### 31.2 **Facilities for Other Contractors**

If, however, pursuant to Sub-Clause 31.1 the Contractor shall, on the written request of the Engineer:

- (a) make available to any other contractor, or to the Employer or any such authority, any roads or ways for the maintenance of which the Contractor is responsible,



(b) permit the use, by any such, of Temporary Works or Contractor's Equipment on the Site, or

(c) provide any other service of whatsoever nature for any such,

the Engineer shall determine an addition to the Contract Price in accordance with Clause 52 and shall notify the Contractor accordingly, with a copy to the Employer.

**32.1 Contractor to Keep Site Clear**

During the execution of the Works the Contractor shall keep the Site reasonably free from all unnecessary obstruction and shall store or dispose of any Contractor's Equipment and surplus materials and clear away and remove from the Site any wreckage, rubbish or Temporary Works no longer required.

**33.1 Clearance of Site on Completion**

Upon the issue of any Taking-Over Certificate the Contractor shall clear away and remove from that part of the Site to which such Taking-Over Certificate relates all Contractor's Equipment, surplus materials, rubbish and Temporary Works of every kind, and leave such part of the Site and Works clean and in a workmanlike condition to the satisfaction of the Engineer. Provided that the Contractor shall be entitled to retain on Site, until the end of the Defects Liability Period, such materials, Contractor's Equipment and Temporary Works as are required by him for the purpose of fulfilling his obligations during the Defects Liability Period.

**Labour**

**34.1 Engagement of Staffs and Labour**

The Contractor shall, unless otherwise provided in the Contract, make his own arrangements for the engagement of all staff and labour, local or other, and for their payment, housing, feeding and transport.

**35.1 Returns of Labour and Contractor's Equipment**

The Contractor shall, if required by the Engineer, deliver to the Engineer a return in detail, in such form and at such intervals as the Engineer may prescribe, showing the staff and the numbers of the several classes of labour from time to time employed by the Contractor on the Site and such information respecting Contractor's Equipment as the Engineer may require.

**Materials, Plant and Workmanship**

**36.1 Quality of Materials, Plant and Workmanship**

All materials, Plant and workmanship shall be:

(a) of the respective kinds described in the Contract and in accordance with the

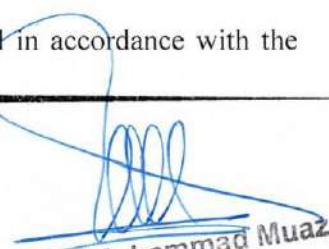
  
Muhammad Muaz  
C.E (P/Line)  
Ext. 5065



Engineer's instructions, and

(b) subjected from time to time to such tests as the Engineer may require at the place of manufacture, fabrication or preparation, or on the Site or at such other place or places as may be specified in the Contract, or at all or any of such places.

The Contractor shall provide such assistance, labour, electricity, fuels, stores, apparatus and instruments as are normally required for examining, measuring and testing any materials or Plant and shall supply samples of materials, before incorporation in the Works, for testing as may be selected and required by the Engineer.

**36.2 Cost of Samples**

All samples shall be supplied by the Contractor at his own cost if the supply thereof is clearly intended by or provided for in the Contract.

**36.3 Cost of Tests**

The cost of making any test shall be borne by the Contractor if such test

is: (a) clearly intended by or provided for in the Contract, or

(b) particularised in the Contract (in cases only for a test under load or of a test to ascertain whether the design of any finished or partially finished work is appropriate for the purposes which it was intended to fulfill) in sufficient detail to enable the Contractor to price or allow for the same in his Tender.

**36.4 Cost of Tests not Provided for**

If any test required by the Engineer which

is: (a) not intended by or provided for,

(b) (in the cases above mentioned) not so particularized, or

(c) (through so intended or provided for) required by the Engineer to be carried out at any place other than the Site or the place of manufacture, fabrication or preparation of the materials or Plant tested,

shows the materials, Plant or workmanship not to be in accordance with the provisions of the Contract to the satisfaction of the Engineer, then the cost of such test shall be borne by the Contractor, but in any other case Sub-Clause 36.5 shall apply.

**36.5 Engineer's Determination where Tests not provided for**

Where, pursuant to Sub-Clause 36.4, this Sub-Clause applies the Engineer shall, after due consultation with the Employer and the Contractor, determine:

  
Muhammad Muaz  
C.E (P/Line)  
Ext. 5065



- (a) any extension of time of which the Contractor is entitled under Clause 44, and
  - (b) the amount of such costs, which shall be added to the Contract Price,
- and shall notify the Contractor accordingly, with a copy to the Employer.

**37.1 Inspection of Operations**

The Engineer, and any person authorized by him, shall at all reasonable times have access to the Site and to all workshops and places where materials or Plant are being manufactured, fabricated or prepared for the Works and the Contractor shall afford every facility for and every assistance in obtaining the right to such access.

**37.2 Inspection and Testing**

The Engineer shall be entitled, during manufacture, fabrication or preparation to inspect and test the materials and Plant to be supplied under the Contract. If materials or Plant are being manufactured, fabricated or prepared in workshops or places other than those of the Contractor, the Contractor shall obtain permission for the Engineer to carry out such inspection and testing in those workshops or places. Such inspection or testing shall not release the Contractor from any obligation under the Contract.

**37.3 Dates for Inspection and Testing**

The Contractor shall agree with the Engineer on the time and place for the inspection or testing of any materials or Plant as provided in the Contract. The Engineer shall give the Contractor not less than 24 hours notice of his intention to carry out the inspection or to attend the tests. If the Engineer, or his duly authorised representative, does not attend on the date agreed, the Contractor may, unless otherwise instructed by the Engineer, proceed with the tests, which shall be deemed to have been made in the presence of the Engineer. The Contractor shall forthwith forward to the Engineer duly certified copies of the tests readings. If the Engineer has not attended the tests, he shall accept the said readings as accurate

If, at the time and place agreed in accordance with Sub-Clause 37.3, the materials or Plant are not ready for inspection or testing or if, as a result of the inspection or testing referred to in this Clause, the Engineer determines that the materials or Plant are defective or otherwise not in accordance with the Contract, he may reject the materials or Plant and shall notify the Contractor thereof immediately. The notice shall state the Engineer's objections with reasons. The Contractor shall then promptly make good the defect or ensure that rejected materials or Plant comply with the Contract. If the Engineer so requests, the tests of rejected materials or Plant shall be made or repeated under the same terms and conditions. All costs incurred by the Employer by the repetition of the test shall after due consultation with the Employer and the Contractor, be determined by the Engineer and shall be recoverable from the Contractor by the Employer and may be deducted from any monies due or to become due to the Contractor and the Engineer shall notify the Contractor accordingly, with a



copy to the Employer.

### 37.5 **Independent Inspection**

The Engineer may delegate inspection and testing of materials or Plant to an independent inspector. Any such delegation shall be effected in accordance with Sub-Clause 2.4 and for this purpose such independent inspector shall be considered as an assistant of the Engineer. Notice of such appointment (not being less than 14 days) shall be given by the Engineer to the Contractor.

### 38.1 **Examination of Work before Covering up**

No part of the works shall be covered up or put out of view without the approval of the Engineer and the Contractor shall afford full opportunity for the Engineer to examine and measure any such part of the Works which is about to be covered up or put out of view and to examine foundations before any part of the Works is placed thereon. The Contractor shall give notice to the Engineer whenever any such part of the Works or foundations is or are ready or about to be ready for examination and the Engineer shall, without unreasonable delay, unless he considers it unnecessary and advises the Contractor accordingly, attend for the purpose of examining and measuring such part of the Works or of examining such foundations.

### 38.2 **Uncovering and Making Openings**

The Contractor shall uncover any part of the Works or make openings in or through the same as the Engineer may from time to time instruct and shall reinstate and make good such part. If any such part has been covered up or put out of view after compliance with the requirement of Sub-Clause 38.1 and is found to be executed in accordance with the Contract, the Engineer shall, after due consultation with the Employer and the Contractor, determine the amount the Contractor's costs in respect of such of uncovering, making openings in or through, reinstating and making good the same, which shall be added to the Contract Price, and shall notify the Contractor accordingly, with a copy to the Employer. In any other case all costs shall be borne by the Contractor.

### 39.1 **Removal of Improper Work, Materials or Plant**

The Engineer shall have authority to issue instructions from time to time, for:

- (a) the removal from the Site, within such time or times as may be specified in the instruction, of any materials or Plant which, in the opinion of the Engineer, are not in accordance with the Contract,
- (b) the substitution of proper and suitable materials or Plant, and
- (c) the removal and proper re-execution, notwithstanding any previous test thereof or interim payment therefore, of any work which, in respect of
  - (i) materials, Plant or workmanship, or



(ii) design by the Contractor or for which he is responsible,

is not, in the opinion of the Engineer, in accordance with the Contract.

### 39.2 **Default of Contractor in Compliance**

In case of default on the part of Contractor in carrying out such instruction within the time specified therein or, if none, within a reasonable time, the Employer shall be entitled to employ and pay other persons to carry out the same and all costs consequent thereon or incidental thereto shall, after due consultation with the Employer and the Contractor, be determined by the Engineer and shall be recoverable from the Contractor by the Employer, and may be deducted by the Employer from any monies due or to become due to the Contractor and the Engineer shall notify the Contractor accordingly, with a copy to the Employer.

### Suspension

#### 40.1 **Suspension of Work**

The Contractor shall, on the instructions of the Engineer, suspend the progress of the Works or any part thereof for such time and in such manner as the Engineer may consider necessary and shall, during such suspension, properly protect and secure the Works or such part thereof so far as is necessary in the opinion of the Engineer. Unless such suspension is:

- (a) otherwise provided for in the Contract,
- (b) necessary by reason of some default of or breach of contract by the Contractor or for which he is responsible,
- (c) necessary by reason of climatic conditions of the Site, or
- (d) necessary for the proper execution of the Works or for the safety of the Works or any part thereof (save to the extent that such necessity arises from any act or default by the Engineer or the Employer or from any of the risks defined in Sub-Clause 20.4), Sub-Clause 40.2 shall apply.

#### 40.2 **Engineer's Determination following Suspension**

Where, pursuant to Sub-Clause 40.1, this Sub-Clause applies the Engineer shall, after due consultation with the Employer and the Contractor, determine:

- (a) any extension of time to which the Contractor is entitled under Clause 44, and
- (b) the amount, which shall be added to the Contract Price, in respect of the cost incurred by the Contractor by reason of such suspension,

and shall notify the Contractor accordingly, with a copy to the Employer.



### 40.3 Suspension lasting more than 84 Days

If the progress of the Works or any part thereof is suspended on the written instructions of the Engineer and if permission to resume work is not given by the Engineer within a period for 84 days from the date of suspension then, unless such suspension is within paragraph (a), (b), (c) or (d) of Sub-Clause 40.1, the Contractor may give notice to the Engineer requiring permission, within 28 days from the receipt thereof, to proceed with the Works or that part thereof in regard to which progress is suspended. If, within the said time, such permission is not granted, the Contractor may, but is not bound to, elect to treat the suspension, where it affects part only of the Works, as an omission of such part under Clause 51 by giving a further notice to the Engineer to that effect, or, where it affects the whole of the Works, treat the suspension as an event of default by the Employer and terminates his employment under the Contract in accordance with the provisions of Sub-Clause 69.1, whereupon the provisions of Sub-Clause 69.2 and 69.3 shall apply.

### Commencement and Delays

#### 41.1 Commencement of Works

The Contractor shall commence the Works as soon as is reasonably possible after the receipt by him of notice to this effect from the Engineer, which notice shall be issued within the time stated in the Appendix to Tender after the date of the Letter of Acceptance. Thereafter, the Contractor shall proceed with the Works with due expedition and without delay.

#### 42.1 Possession of Site and Access Thereto

Save insofar as the Contract may prescribe:

(a) the extent of portions of the Site of which the Contractor is to be given possession from time to time,

(b) the order in which such portions shall be made available to the Contractor, and, subject to any requirement in the Contract as to the order in which the Works shall be executed, the Employer will, with the Engineer's notice to commence the Works, give to the Contractor possession of

(c) so much of the Site, and

(d) such access as, in accordance with the Contract, is to be provided by the Employer as may be required to enable the Contractor to commence and proceed with the execution of the Works in accordance with the programme referred to in Clause 14, if any, and otherwise in accordance with such reasonable proposals as the Contractor shall, by notice to the Engineer with a copy to the Employer, make. The Employer will, from time to time as the Works proceed, give to the Contractor possession of such further portions of the Site as may be required to enable the Contractor to proceed with the execution of the Works with due dispatch in accordance with such programme or proposals, as the case may be.





**42.2 Failure to Give Possession**

If the Contractor suffers delay and/or incurs costs from failure on the part of the Employer to give possession in accordance with the terms of Sub-Clause 42.1, the Engineer shall, after due consultation with the Employer and the Contractor, determine:

- (a) any extension of time to which the Contractor is entitled under Clause 44, and
  - (b) the amount of such costs, which shall be added to the Contract Price,
- and shall notify the Contractor accordingly, with a copy to the Employer.

**42.3 Rights of Way and Facilities**

The Contractor shall bear all costs and charges for special or temporary way leaves required by him in connection with access to the Site. The Contractor shall also provide at his own cost any additional facilities outside the Site required by him for the purposes of the Works.

**43.1 Time for Completion**

The whole of the Works and, if applicable, any Section required to be completed within a particular time as stated in the Appendix to Tender, shall be completed, in accordance with the provisions of Clause 48, within the time stated in the Appendix to Tender for the whole of the Works or the Section (as the case may be), calculated from the Commencement Date, or such extended time as may be allowed under Clause 44.

**44.1 Extension of Time for Completion**

In the event of:

- (a) the amount or nature of extra or additional work,
- (b) any cause of delay referred to in these Conditions,
- (c) exceptionally adverse climatic conditions,
- (d) any delay, impediment or prevention by the Employer, or
- (e) other special circumstances which may occur, other than through a default of or breach of contract by the Contractor or for which he is responsible,

being such as fairly to entitle the Contractor to an extension of the Time for Completion of the Works, or any Section or part thereof, the Engineer may, after due consultation with the Employer and the Contractor, consider the amount of such extension or otherwise and shall notify the Contractor accordingly, with a copy to the

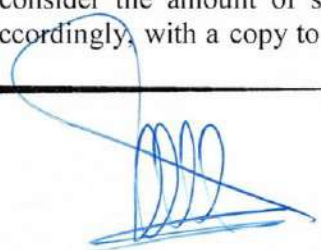
  
**Muhammad Muaz**  
C.E (P/Line)  
Ext: 5065



Employer.

#### 44.2 **Contractor to Provide Notification and Detailed Particulars**

Provided that the Engineer is not bound to make any consideration unless the Contractor has

(a) within 14 days after such event has first arisen notified the Engineer with a copy to the Employer, and

(b) within 14 days or such other reasonable time as may be agreed by the Engineer, after such notification submitted to the Engineer detailed particulars of any extension of time to which he may consider himself entitled in order that such submission may be investigated at the time.

#### 44.3 **Interim Determination of Extension**

Provided also that where an event has a continuing effect such that it is not practicable for the Contractor to submit detailed particulars within the period of 14 days referred to in Sub-Clause 44.2(b), he shall nevertheless be entitled to an extension of time provided that he has submitted to the Engineer interim particulars at intervals of not more than 14 days and final particulars within 14 days of the end of the effects resulting from the event. On receipt of such interim particulars, the Engineer shall, without undue delay, make an interim determination of extension of time and, on receipt of the final particulars, the Engineer shall review all the circumstances and shall determine an overall extension of time in regard to the event. In both such cases the Engineer shall make his determination after due consultation with the Employer and the Contractor and shall notify the Contractor of the determination, with a copy to the Employer. No final review shall result in a decrease of any extension of time already determined by the Engineer.

#### 45.1 **Restriction on Working Hours**

Subject to any provision to the contrary contained in the Contract, none of the Works shall, save as hereinafter provided, be carried on during the night or on locally recognized days of rest without the consent of the Engineer, except when work is unavoidable or absolutely necessary for the saving of life or property or for the safety of the Works, in which case the Contractor shall immediately advise the Engineer. Provided that the provisions of this Clause shall not be applicable in the case of any work which it is customary to carry out by multiple shifts.

#### 46.1 **Rate of Progress**

If for any reason, which does not entitle the Contractor to an extension of time, the rate of progress of the Works or any Section is at any time, in the opinion of the Engineer, too slow to comply with the Time for Completion, the Engineer shall so notify the Contractor who shall thereupon take such steps as are necessary, subject to the consent of the Engineer, to expedite progress so as to comply with the Time for Completion. The Contractor shall not be entitled to any additional payment for taking



such steps. If, as a result of any notice given by the Engineer under this Clause, the Contractor considers that it is necessary to do any work at night or on locally recognized days of rest, he shall be entitled to seek the consent of the Engineer so to do. Provided that if any steps, taken by the Contractor in meeting his obligations under this Clause, involve the Employer in additional supervision costs, such cost shall, after due consultation with the Employer and the Contractor, be determined by the Engineer and shall be recoverable from the Contractor by the Employer, and may be deducted by the Employer from any monies due or to become due to the Contractor and the Engineer shall notify the Contractor accordingly, with a copy to the Employer.

#### 47.1 **Liquidated Damages for Delay**

If the Contractor fails to comply with the Time for Completion in accordance with Clause 48, for the whole of the Works or, if applicable, any Section within the relevant time prescribed by Clause 43, then the Contractor shall pay to the Employer the relevant sum stated in the Appendix to Tender as liquidated damages for such default and not as a penalty (which sum shall be the only monies due from the Contractor for such default) for every day or part of a day which shall elapse between the relevant Time for Completion and the date stated in a Taking-Over Certificate of the whole of the Works or the relevant Section, subject to the applicable limit stated in the Appendix to Tender. The Employer may, without prejudice to any other method of recovery, deduct the amount of such damages from any monies due or to become due to the Contractor. The payment or deduction of such damages shall not relieve the Contractor from his obligation to complete the Works, or from any other of his obligations and liabilities under the Contract.

#### 47.2 **Reduction of Liquidated Damages**

If, before the Time for Completion of the whole of the Works or, if applicable, any Section, a Taking-Over Certificate has been issued for any part of the Works or of a Section, the liquidated damages for delay in completion of the remainder of the Works or of that Section shall, for any period of delay after the date stated in such Taking-Over Certificate, and in the absence of Alternative provisions in the Contract, be reduced in the proportion which the value of the part so certified bears to the value of the whole of the Works or Section, as applicable. The provisions of this Sub-Clause shall only apply to the rate of liquidated damages and shall not affect the limit thereof.

#### 48.1 **Taking-Over Certificate**

When the whole of the Works have been substantially completed and have satisfactorily passed any Tests on Completion prescribed by the Contract, the Contractor may give a notice to that effect to the Engineer with a copy to the Employer, accompanied by a written undertaking to finish with due expedition any outstanding work during the Defects Liability Period. Such notice and undertaking shall be deemed to be a request by the Contractor for the Engineer to issue a Taking-Over Certificate in respect of the Works. The Engineer shall within 21 days of the date of delivery of such notice, either issue to the Contractor, with a copy to the



Employer, a Taking-Over Certificate, stating the date on which, in his opinion, the Works were substantially completed in accordance with the Contract, or give instructions in writing to the Contractor specifying all the work which, in the Engineer's opinion, is required to be done by the Contractor before the issue of such Certificate. The Engineer shall also notify the Contractor of any defects in the Works affecting substantial completion that may appear after such instructions and before completion of the Works specified therein. The Contractor shall be entitled to receive such Taking-Over Certificate within 21 days of completion, to the satisfaction of the Engineer, of the Works so specified and remedying any defects so notified.

#### 48.2 **Taking Over of Sections or Parts**

Similarly, in accordance with the procedure set out in Sub-Clause 48.1, the Contractor may request and the Engineer shall issue a Taking-Over Certificate in respect of:

- (a) any Section in respect of which a separate Time for Completion is provided in the Appendix to Tender,
- (b) any substantial part of the Permanent Works which has been both completed to the satisfaction of the Engineer and, otherwise than as provided for in the Contract, occupied or used by the Employer, or
- (c) any part of the Permanent Works which the Employer has elected to occupy or use prior to completion (where such prior occupation or use is not provided for in the Contract or has not been agreed by the Contractor as a temporary measure).

#### 48.3 **Substantial Completion of Parts**

If any part of the Permanent Works has been substantially completed and has satisfactorily passed any Tests on Completion prescribed by the Contractor, the Engineer may issue a Taking-Over Certificate in respect of that part of the Permanent Works before completion of the whole of the Works and, upon the issue of such Certificate, the Contractor shall be deemed to have undertaken to complete with due expedition any outstanding work in that part of the Permanent Works during the Defects Liability Period.

#### 48.4 **Surfaces Requiring Reinstatement**

Provided that a Taking-Over Certificate given in respect of any Section or part of the Permanent Works before completion of the whole of the Works shall not be deemed to certify completion of any ground or surfaces requiring reinstatement, unless such Taking-Over Certificate shall expressly so state.



**Defects Liability**

**49.1 Defects Liability Period**

In these Conditions the expression "Defects Liability Period" shall mean the defects liability period named in the Appendix to Tender, calculated from:

- (a) the date of completion of the Works certified by the Engineer in accordance with Clause 48, or
- (b) in the event of more than one certificate having issued by the Engineer under Clause 48, the respective dates so certified,

and in relation to the Defects Liability Period the expression "the Works" shall be construed accordingly.

**49.2 Completion of Outstanding Work and Remedying Defects**

To the intent that the Works shall, at or as soon as practicable after the expiration of the Defects Liability Period, be delivered to the Employer in the condition required by the Contract, fair wear and tear excepted, to the satisfaction of the Engineer, the Contractor shall:

- (a) complete the work, if any, outstanding on the date stated in the Taking-Over Certificate as soon as practicable after such date, and
- (b) execute all such work of amendment, reconstruction, and remedying defects, shrinkages or other faults as the Engineer may, during the Defects Liability Period or within 14 days after its expiration, as a result of an inspection made by or on behalf of the Engineer prior to its expiration, instruct the Contractor to execute.

**49.3 Cost of Remedying Defects**

All work referred to in Sub-Clause 49.2(b) shall be executed by the Contractor at his own cost if the necessity thereof is, in the opinion of the Engineer, due to:

- (a) the use of materials, Plant or workmanship not in accordance with the Contract,
- (b) where the Contractor is responsible for the design of part of the Permanent Works, any fault in such design, or
- (c) the neglect or failure on the part of the Contractor to comply with any obligation, expressed or implied, on the Contractor's part under the Contract.

If, in the opinion of the Engineer, such necessity is due to any other cause, he shall determine an addition to the Contract Price in accordance with Clause 52 and shall notify the Contractor accordingly, with a copy to the Employer.

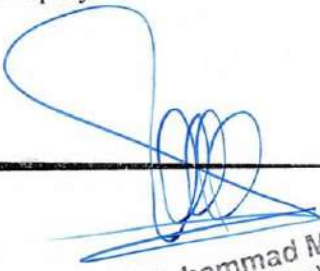
  
**Muhammad Muaz**  
C.E (P/Line)  
Ext. 5065

**49.4 Contractor's Failure to Carry Out Instructions**

In case of default on the part of the Contractor in carrying out such instruction within a reasonable time, the Employer shall be entitled to employ and pay other persons to carry out the same and if such work is work which, in the opinion of the Engineer, the Contractor was liable to do at his own cost under the Contract, then all cost consequent thereon or incidental thereto shall, after due consultation with the Employer and the Contractor, be determined by the Engineer and shall be recoverable from the Contractor by the Employer, and may be deducted by the Employer from any monies due or to become due to the Contractor and the Engineer shall notify the Contractor accordingly, with a copy to the Employer.

**50.1 Contractor to Search**

If any defect, shrinkage or other fault in the Works appears at any time prior to the end of the Defects Liability Period, the Engineer may instruct the Contractor, with a copy to the Employer, to search under the directions of the Engineer for the cause thereof. Unless such defect, shrinkage or other fault is one for which the Contractor is liable under the Contract, the Engineer shall, after due consultation with the Employer and the Contractor, determine the amount in respect of the costs of such search incurred by the Contractor, which shall be added to the Contract Price and shall notify the Contractor accordingly, with a copy to the Employer. If such defect, shrinkage or other fault is one for which the Contractor is liable, the cost of the work carried out in searching as aforesaid shall be borne by the Contractor and he shall in such case remedy such defect, shrinkage or other fault at his own cost in accordance with the provisions of Clause 49.

**Alterations, Additions and Omissions****51.1 Variations**

The Engineer shall make any variation of the form, quality or quantity of the Works or any part thereof that may, in his opinion, be necessary and for that purpose, or if for any other reason it shall, in his opinion, be appropriate, he shall have the authority to instruct the Contractor to do and the Contractor shall do any of the following:

- (a) increase or decrease the quantity of any work included in the Contract,
- (b) omit any such work (but not if the omitted work is to be carried out by the Employer or by another contractor),
- (c) change the character or quality or kind of any such work,
- (d) change the levels, lines, position and dimensions of any part of the Works,
- (e) execute additional work of any kind necessary for the completion of the Works, or
- (f) change any specified sequence or timing of construction of any part of the Works.

No such variation shall in any way vitiate or invalidate the Contract, but the effect, if any, of all such variations shall be valued in accordance with Clause 52. Provided that where the issue of an instruction to vary the Works is necessitated by some default of



or breach of contract by the Contractor or for which he is responsible, any additional cost attributable to such default shall be borne by the Contractor.

#### 51.2 Instructions for Variations

The Contractor shall not make any such variation without an instruction of the Engineer. Provided that no instruction shall be required for increase or decrease in the quantity of any work where such increase or decrease is not the result of an instruction given under this Clause, but is the result of the quantities exceeding or being less than those stated in the Bill of Quantities.

#### 52.1 Valuation of Variations

All variations referred to in Clause 51 and any additions to the Contract Price which are required to be determined in accordance with Clause 52 (for the purposes of this Clause referred to as "varied work"), shall be valued at the rates and prices set out in the Contract if, in the opinion of the Engineer, the same shall be applicable. If the Contract does not contain any rates or prices applicable to the varied work, the rates and prices in the Contract shall be used as the basis for valuation so far as may be reasonable, failing which, after due consultation by the Engineer with the Employer and the Contractor, suitable rates or prices shall be agreed upon between the Engineer and the Contractor. In the event of disagreement the Engineer shall fix such rates or prices as are, in his opinion, appropriate and shall notify the Contractor accordingly, with a copy to the Employer. Until such time as rates or prices are agreed or fixed, the Engineer shall determine provisional rates or prices to enable on-account payments to be included in certificates issued in accordance with Clause 60.

#### 52.2 Power of Engineer to Fix Rates

Provided that if the nature or amount of any varied work relative to the nature or amount of the whole of the Works or to any part thereof, is such that, in the opinion of the Engineer, the rate or price contained in the Contract for any item of the Works is, by reason of such varied work, rendered inappropriate or inapplicable, then, after due consultation by the Engineer with the Employer and the Contractor, a suitable rate or price shall be agreed upon between the Engineer and the Contractor. In the event of disagreement the Engineer shall fix such other rate or price as is, in his opinion, appropriate and shall notify the Contractor accordingly, with a copy to the Employer. Until such time as rates or prices are agreed or fixed, the Engineer shall determine provisional rates or prices to enable on-account payments to be included in certificates issued in accordance with Clause 60.

Provided also that no varied work instructed to be done by the Engineer pursuant to Clause 51 shall be valued under Sub-Clause 52.1 or under this Sub-Clause unless, within 14 days of the date of such instruction and, other than in the case of omitted work, before the commencement of the varied work, notice shall have been given either:

(a) by the Contractor to the Engineer of his intention to claim extra payment or a varied rate or price, or



(b) by the Engineer to the Contractor of his intention to vary a rate or price.

### 52.3 Variations Exceeding 15 per cent

If, on the issue of the Taking-Over Certificate for the whole of the Works, it is found that as a result of:

- (a) all varied work valued under Sub-Clauses 52.1 and 52.2, and
- (b) all adjustments upon measurement of the estimated quantities set out in the Bill of Quantities, excluding Provisional Sums, day works and adjustment of price made under Clause 70.

but not from any other cause, there have been additions to or deductions from the Contract Price which taken together are in excess of 15 per cent of the "Effective Contract Price" (which for the purposes of this Sub-Clause shall mean the Contract Price, excluding Provisional Sums and allowance for day works, if any) then and in such event (subject to any action already taken under any other Sub-Clause of this Clause), after due consultation by the Engineer with the Employer and the Contractor, there shall be added to or deducted from the Contract Price such further sums as may be agreed between the Contractor and the Engineer or, failing agreement, determined by the Engineer having regard to the Contractor's Site and general overhead costs of the Contract. The Engineer shall notify the Contractor of any determination made under this Sub-Clause, with a copy to the Employer. Such sum shall be based only on the amount by which such additions or deductions shall be in excess of 15 per cent of the Effective Contract Price.

### 52.4 Day work

The Engineer may, if in his opinion it is necessary or desirable, issue an instruction that any varied work shall be executed on a day work basis. The Contractor shall then be paid for such varied work under the terms set out in the day work schedule included in the Contract and at the rates and prices affixed thereto by him in the Tender.

The Contractor shall furnish to the Engineer such receipts or other vouchers as may be necessary to provide the amounts paid and, before ordering material, shall submit to the Engineer quotations for the same for his approval.

In respect of such of the Works executed on a day work basis, the Contractor shall during the continuance of such work, deliver each day to the Engineer an exact list in duplicate of the names, occupation and time of all workmen employed on such work and a statement, also in duplicate, showing the description and quantity of all materials and Contractor's Equipment used thereon or therefore other than Contractor's Equipment which is included in the percentage addition in accordance with such day work schedule. One copy of each list and statement will, if correct, or when agreed, be signed by the Engineer and returned to the Contractor.





At the end of each month the Contractor shall deliver to the Engineer a priced statement of the labour, materials and Contractor's Equipment, except as aforesaid, used and the Contractor shall not be entitled to any payment unless such lists and statements have been fully and punctually rendered. Provided always that if the Engineer considers that for any reason the sending of such lists or statements by the Contractor, in accordance with the foregoing provision, was impracticable he shall nevertheless be entitled to authorize payment for such work, either as day work, on being satisfied as to the time employed and the labour, materials and Contractor's Equipment used on such work, or at such value therefore as shall, in his opinion, be fair and reasonable.

### Procedure for Claims

#### 53.1 Notice of Claims

Notwithstanding any other provision of the Contract, if the Contractor intends to claim any additional payment pursuant to any Clause of these Conditions or otherwise, he shall give notice along with supporting documents of his intention to the Engineer with a copy to the Employer, within 28 days after the event giving rise to the claim has first arisen.

#### 53.2 Contemporary Records

Upon the happening of the event referred to in Sub-Clause 53.1, the Contractor shall keep such contemporary records as may reasonably be necessary to support any claim he may subsequently wish to make. Without necessarily admitting the Employer's liability, the Engineer shall, on receipt of a notice under Sub-Clause 53.1, inspect such contemporary records and may instruct the Contractor to keep any further contemporary records as are reasonable and may be material to the claim of which notice has been given. The Contractor shall permit the Engineer to inspect all records kept pursuant to this Sub-Clause and shall supply him with copies thereof as and when the Engineer so instructs.

#### 53.3 Substantiation of Claims

Within 28 days, or such other reasonable time as may be agreed by the Engineer, of giving notice under Sub-Clause 53.1, the Contractor shall send to the Engineer an account giving detailed particulars of the amount claimed and the grounds upon which the claim is based. Where the event giving rise to the claim has a continuing effect, such account shall be considered to be an interim account and the Contractor shall, at such intervals as the Engineer may reasonably require, send further interim accounts giving the accumulated amount of the claim and any further grounds upon which it is based. In cases where interim accounts are sent to the Engineer, the Contractor shall send a final account within 28 days of the end of the effects resulting from the event. The Contractor shall, if required by the Engineer so to do, copy to the Employer all accounts sent to the Engineer pursuant to this Sub-Clause.

#### 53.4 Failure to Comply



If the Contractor fails to comply with any of the provisions of this Clause in respect of any claim which he seeks to make, his entitlement to payment in respect thereof shall not exceed such amount as the Engineer or any arbitrator or arbitrators appointed pursuant to Sub-Clause 67.3 assessing the claim considers to be verified by contemporary records (whether or not such records were brought to the Engineer's notice as required under Sub-Clause 53.2 and 53.3).

#### 53.5 **Payment of Claims**

The Contractor shall be entitled to have included in any interim payment certified by the Engineer pursuant to Clause 60 such amount in respect of any claim as the Engineer, after due consultation with the Employer and the Contractor, may consider due to the Contractor provided that the Contractor has supplied sufficient particulars to enable the Engineer to determine the amount due. If such particulars are insufficient to substantiate the whole of the claim, the Contractor shall be entitled to payment in respect of such part of the claim as such particulars may substantiate to the satisfaction of the Engineer. The Engineer shall notify the Contractor of any determination made under this Sub-Clause, with a copy to the Employer.

#### **Contractor's Equipment, Temporary Works and Materials**

#### 54.1 **Contractor's Equipment, Temporary Works and Materials; Exclusive Use for the Works**

All Contractor's Equipment, Temporary Works and materials provided by the Contractor shall, when brought on to the Site, be deemed to be exclusively intended for the execution of the Works and the Contractor shall not remove the same or any part thereof, except for the purpose of moving it from one part of the Site to another, without the consent of the Engineer. Provided that consent shall not be required for vehicles engaged in transporting any staff, labour, Contractor's Equipment, Temporary Works, Plant or materials to or from the Site.

#### 54.2 **Employer not Liable for Damage**

The Employer shall not at any time be liable, save as mentioned in Clauses 20 and 65, for the loss of or damage to any of the said Contractor's Equipment, Workforce, Temporary Works or Materials.

#### 54.3 **Customs Clearance**

The Employer will use his best endeavors in assisting the Contractor, where required, in obtaining clearance through the Customs of Contractor's equipment, materials and other things required for the Works.

#### 54.4 **Re-export of Contractor's Equipment**



In respect of any Contractor's Equipment which the Contractor has imported for the purposes of the Works, the Employer will use his best endeavors to assist the Contractor, where required, in procuring any necessary Government consent to the re-export of such Contractor's Equipment by the Contractor upon the removal thereof pursuant to the terms of Contract.

#### 54.5 **Conditions of Hire of Contractor's Equipment**

With a view to securing, in the event of termination under Clause 63, the continued availability, for the purpose of executing the Works, of any hired Contractor's Equipment, the Contractor shall not bring on to the Site any hired Contractor's Equipment unless there is an agreement for hire thereof (which agreement shall be deemed not to include an agreement for hire purchase) which contains a provision that the owner thereof will, on request in writing made by the Employer within 7 days after the date on which any termination has become effective, and on the Employer undertaking to pay all hire charges in respect thereof from such date, hire such Contractor's Equipment to the Employer on the same terms in all respect as the same was hired to the Contractor save that the Employer shall be entitled to permit the use thereof by any other contractor employed by him for the purpose of execution and completing the Works and remedying any defects therein, under the terms of the said Clause 63.

#### 54.6 **Costs for the Purpose of Clause 63**

In the event of the Employer entering into any agreement for the hire of Contractor's Equipment pursuant to Sub-Clause 54.5, all sums properly paid by the Employer under the provision of any such agreement and all costs incurred by him (including stamp duties) in entering into such agreement shall be deemed, for the purpose of Clause 63, to be part of the cost of executing and completing the Works and the remedying of any defects therein.

#### 54.7 **Incorporation of Clause in Subcontracts**

The Contractor shall, where entering into any subcontract for the execution of any part of the Works, incorporate in such subcontract (by reference or otherwise) the provisions of this Clause in relation to Contractor's Equipment, Temporary Works or materials brought on to the Site by the Subcontractor.

#### 54.8 **Approval of Materials not implied**

The operation of this Clause shall not be deemed to imply any approval by the Engineer of the materials or other matters referred to therein nor shall it prevent the rejection of any such materials at any time by the Engineer.

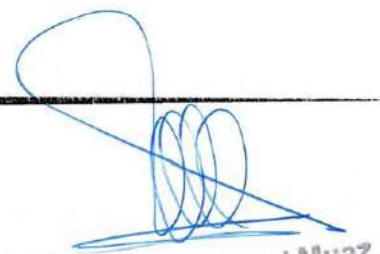

**Muhammad Muaz**  
C.E (P/Line)  
Ext: 5065



## Measurement

### 55.1 Quantities

The quantities set out in the Bill of Quantities are the estimated quantities for the Works, and they are not to be taken as the actual and correct quantities of the Works to be executed by the Contractor in fulfillment of his obligations under the Contract.

### 56.1 Works to be measured

The Engineer shall, except as otherwise stated, ascertain and determine by measurement the value of the Works in accordance with the Contract and the Contractor shall be paid that value in accordance with Clause 60. The Engineer shall, when he requires any part of the Works to be measured, give reasonable notice to the Contractor's authorized agent, who shall:

(a) forthwith attend or send a qualified representative to assist the Engineer in making such measurement, and

(b) supply all particulars required by the Engineer.

Should the Contractor not attend, or neglect or omit to send such representative, then the measurement made by the Engineer or approved by him shall be taken to be the correct measurement of such part of the Works. For the purpose of measuring such Permanent Works as are to be measured by records and drawings, the Engineer shall prepare records and drawings as the work proceeds and the Contractor, as and when called upon to do so in writing, shall, within 14 days, attend to examine and agree such records and drawings with the Engineer and shall sign the same when so agreed. If the Contractor does not attend to examine and agree such records and drawings, they shall be taken to be correct. If, after examination of such records and drawings, the Contractor does not agree the same or does not sign the same as agreed, they shall nevertheless be taken to be correct, unless the Contractor, within 14 days of such examination, lodges with the Engineer notice of the respects in which such records and drawings are claimed by him to be incorrect. On receipt of such notice, the Engineer shall review the records and drawings and either confirm or vary them.

### 57.1 Method of Measurement

The Works shall be measured net, notwithstanding any general or local custom, except where otherwise provided for in the Contract.

**57.2 Breakdown of Lump Sum Items**

For the purposes of statements submitted in accordance with Sub-Clause 60.1, the Contractor shall submit to the Engineer, within 28 days after the receipt of the Letter of Acceptance, a breakdown for each of the lump sum items contained in the Tender. Such breakdowns shall be subject to the approval of the Engineer.

**Provisional Sums****58.1 Definition of "Provisional Sum"**

"Provisional Sum" means a sum included in the Contract and so designated in the Bill of Quantities for the execution of any part of the Works or for the supply of goods, materials, Plant or services, or for contingencies, which sum may be used, in whole or in part, or not at all, on the instructions of the Engineer. The Contractor shall be entitled to only such amounts in respect of the work, supply or contingencies to which such Provisional Sums relate as the Engineer shall determine in accordance with this Clause. The Engineer shall notify the Contractor of any determination made under this Sub-Clause, with a copy to the Employer.

**58.2 Use of Provisional Sums**

In respect of every Provisional Sum the Engineer shall have authority to issue instructions for the execution of work or for the supply of goods, material, Plant or services by:

- (a) the Contractor, in which case the Contractor shall be entitled to an amount equal to the value thereof determined in accordance with Clause 52, and
- (b) a nominated Subcontractor, as hereinafter defined, in which case the sum to be paid to the Contractor therefore shall be determined and paid in accordance with Sub-Clause 59.4.

**58.3 Production of Vouchers**

The Contractor shall produce to the Engineer all quotations, invoices, vouchers and accounts or receipts in connection with expenditure in respect of Provisional Sums, except where work is valued in accordance with rates or prices set out in the Tender.



### **Nominated Subcontractors**

#### **59.1 Definition of "Nominated Subcontractors"**

All specialists, merchants, tradesmen and others executing any work or supplying any goods, materials, Plant or services for which Provisional Sums are included in the Contract, who may have been or be nominated or selected or approved by the Employer or the Engineer, and all persons to whom by virtue of the provisions of the Contract the Contractor is required to subcontract shall, in the execution of such work or the supply of such goods, materials, Plant or services, be deemed to be subcontractors to the Contractor and are referred to in this Contract as "nominated Subcontractors".

#### **59.2 Nominated Subcontractors; Objection to Nomination**

The Contractor shall not be required by the Employer or the Engineer, or be deemed to be under any obligation, to employ any nominated Subcontractor against whom the Contractor may raise reasonable objection or who declines to enter into subcontract with the Contractor containing provisions:

- (a) that in respect of the work, goods, materials, Plant or services the subject of the subcontract, the nominated Subcontractor will undertake towards the Contractor such obligations and liabilities as will enable the Contractor to discharge his own obligations and liabilities towards the Employer under the terms of the Contract and will save harmless and indemnify the Contractor from and against the same and from all claims, proceedings, damages, costs, charges and expenses whatsoever arising out of or in connection therewith, or arising out of or in connection with any failure to perform such obligations or to fulfill such liabilities, and
- (b) that the nominated Subcontractor will save harmless and indemnify the Contractor from and against any negligence by the nominated Subcontractor, his agents, workmen and servants and from and against any misuse by him or them of any Temporary Works provided by the Contractor for the purposes of the Contract and from all claims as aforesaid.

#### **59.3 Design Requirements to be expressly stated**

If in connection with any Provisional Sum the services to be provided include any matter of design or specification of any part of the Permanent Works or of any Plant to be incorporated therein, such requirement shall be expressly stated in the Contract and shall be included in any nominated Subcontract. The nominated Subcontract shall specify that the nominated Subcontractor providing such services will save harmless and indemnify the Contractor from and against the same and from all claims,



proceedings, damages, costs, charges and expenses whatsoever arising out of or in connection with any failure to perform such obligations or to fulfill such liabilities.

**59.4 Payments to Nominated Subcontractors**

For all work executed or goods, materials, Plant or services supplied by any nominated Subcontractor, the Contractor shall be entitled to:

- (a) the actual price paid or due to be paid by the Contractor, on the instructions of the Engineer, and in accordance with the subcontract;
- (b) in respect of labour supplied by the Contractor, the sum, if any, entered in the Bill of Quantities or, if instructed by the Engineer pursuant to paragraph (a) of Sub-Clause 58.2, as may be determined in accordance with Clause 52; and
- (c) in respect of all other charges and profit, a sum being a percentage rate of the actual price paid or due to be paid calculated, where provision has been made in the Bill of Quantities for a rate to be set against the relevant Provisional Sum, at the rate inserted by the Contractor against that item or, where no such provision has been made, at the rate inserted by the Contractor in the Appendix to Tender and repeated where provision for such is made in a special item provided in the Bill of Quantities for such purpose.

**59.5 Certification of Payments to Nominated Subcontractors**

Before issuing, under Clause 60 any certificate, which includes any payment in respect of work done or goods, materials, Plant or services supplied by any nominated Subcontractor, the Engineer shall be entitled to demand from the Contractor reasonable proof that all payments, less retentions, included in previous certificates in respect of the work or goods, materials, Plant or services of such nominated Subcontractor have been paid or discharged by the Contractor. If the Contractor fails to supply such proof then, unless the Contractor:

- (a) Satisfies the Engineer in writing that he has reasonable cause for withholding or refusing to make such payment, and
- (b) produces to the Engineer reasonable proof that he has so informed such nominated Subcontractor in writing,

the Employer shall be entitled to pay to such nominated Subcontractor direct, upon the certificate of the Engineer, all payments, less retention, provided for in the nominated Subcontract, which the Contractor has failed to make to such nominated Subcontractor and to deduct by way of set-off



the amount so paid by the Employer from any sums due or to become due from the Employer to the Contractor.

Provided that, where the Engineer has certified and the Employer has paid direct as aforesaid, the Engineer shall in issuing any further certificate in favour of the Contractor, deduct from the amount thereof the amount so paid, direct as aforesaid, but shall not withhold or delay the issue of the certificate itself when due to be issued under the terms of the Contract.

### Certificates and Payment

#### 60.1 Monthly Statements

The Contractor shall submit to the Engineer after the end of each month six copies, each signed by the Contractor's representative approved by the Engineer in accordance with the Sub-Clause 15.1, of a statement, in such form as the Engineer may from time to time prescribe, showing the amounts to which the Contractor considers himself to be entitled up to the end of the month in respect of:

- (a) the value of the Permanent Works executed,
- (b) any other items in the Bill of Quantities including those for Contractor's Equipment, Temporary Works, day works and the like,
- (c) the percentage of the invoice value of listed materials, all as stated in the Appendix to Tender, and Plant delivered by the Contractor on the Site for incorporation in the Permanent Works but not incorporated in such Works,
- (d) Adjustments under Clause 70, and
- (e) any other sum to which the Contractor may be entitled under the Contract or otherwise.

#### 60.2 Monthly Payments

The Engineer shall, within 28 days of receiving such statement, certify to the Employer the amount of payment to the Contractor which he considers due and payable in respect thereof, subject:

- (a) firstly, to the retention of the account calculated by applying the Percentage of Retention stated in the Appendix to Tender, to the amount to which the Contractor is entitled under paragraph (a), (b), (c) and (e) of Sub-Clause 60.1 until the amount so retained reaches the Limit of Retention Money stated in the Appendix to





Tender, and

- (b) secondly, to the deduction, other than pursuant to Clause 47, of any sums which may have become due and payable by the Contractor to the Employer.

Provided that the Engineer shall not be bound to certify any payment under this Sub- Clause if the net amount thereof, after all retentions and deductions, would be less than the Minimum Amount of Interim Payment Certificates stated in the Appendix to Tender.

Notwithstanding the terms of this Clause or any other Clause of the Contract no amount will be certified by the Engineer for payment until the performance security, if required under the Contract, has been provided by the Contractor and approved by the Employer.

### 60.3 **Payment of Retention Money**

- (a) Upon the issue of the Taking-Over Certificate with respect to the whole of the Works, one half of the Retention Money, or upon the issue of a Taking-Over Certificate with respect to a Section or part of the Permanent Works only such proportion thereof as the Engineer determines having regard to the relative value of such Section or part of the Permanent Works, shall be certified by the Engineer for payment to the Contractor.
- (b) Upon the expiration of the Defects Liability Period for the Works the other half of the Retention Money shall be certified by the Engineer for payment to the Contractor. Provided that, in the event of different Defects Liability Periods having become applicable to different Sections or part of the Permanent Works pursuant to Clause 48, the expression "expiration of the Defects Liability Period" shall, for the purposes of this Sub-Clause, be deemed to mean the expiration of the latest of such periods. Provided also that if at such time, there shall remain to be executed by the Contractor any work instructed, pursuant to Clause 49 and 50, in respect of the Works, the Engineer shall be entitled to withhold certification until completion of such work of so much of the balance of the Retention Money as shall, in the opinion of the Engineer, represent the cost of the work remaining to be executed.

### 60.4 **Correction of Certificates**

The Engineer may by any Interim Payment Certificate make any correction or modification in any previous certificate which shall have been issued by him and shall have authority, if any work is not being carried out to his satisfaction, to omit or reduce the value of such work in any Interim Payment Certificate.

**60.5 Statement at Completion**

Not later than 84 days after the issue of the Taking-Over Certificate in respect of the whole of the Works, the Contractor shall submit to the Engineer a Statement at Completion with supporting documents showing in detail, in the form approved by the Engineer:

- (a) the final value of all work done in accordance with the Contract up to the date stated in such Taking-Over Certificate,
- (b) any further sums which the Contractor considers to be due, and
- (c) an estimate of amounts which the Contractor considers will become due to him under the Contract.

The estimated amounts shall be shown separately in such Statement at Completion. The Engineer shall verify payment in accordance with Sub-Clause 60.2.

**60.6 Final Statement**

Not later than 56 days after the issue of the Defects Liability Certificate pursuant to Sub-Clause 62.1, the Contractor shall submit to the Engineer for consideration a draft final statement with supporting documents showing in detail, in the form approved by the Engineer:

- (a) the value of all work done in accordance with the Contract, and
- (b) any further sums which the Contractor considers to be due to him under the Contract.

If the Engineer disagrees with or cannot verify any part of the draft final statement, the Contractor shall submit such further information as the Engineer may reasonably require and shall make such changes in the draft as may be agreed between them. The Contractor shall then prepare and submit to the Engineer the final statement as agreed (for the purposes of these Conditions referred to as the "Final Statement").

If, following discussions between the Engineer and the Contractor and any changes to the draft final statement which may be agreed between them, it becomes evident that a dispute exists, the Engineer shall deliver to the Employer an Interim Payment Certificate for those parts of the draft final statement, if any, which are not in dispute. The dispute may then be settled in accordance with Clause 67.

**60.7 Discharge**

Upon submission of the Final Statement, the Contractor shall give to the Employer, with a copy to the Engineer, a written discharge confirming that the total of the Final Statement represents full and final settlement of all monies due to the Contractor arising out of or in respect of the Contract. Provided that such discharge shall become effective only after payment due under the Final Payment Certificate issued pursuant to Sub-Clause 60.8 has been made and the performance security referred to in Sub- Clause 10.1, if any, has been returned to the Contractor.

**60.8 Final Payment Certificate**

Within 28 days after receipt of the Final Statement, and the written discharge, the Engineer shall issue to the Employer (with a copy to the Contractor) a Final Payment Certificate stating:

- (a) the amount which, in the opinion of the Engineer, is finally due under the  
Contract or otherwise, and
- (b) after giving credit to the Employer for all amounts previously paid by the Employer and for all sums to which the Employer is entitled other than under Clause 47, the balance, if any, due from the Employer to the Contractor or from the Contractor to the Employer as the case may be.

**60.9 Cessation of Employer's Liability**

The Employer shall not be liable to the Contractor for any matter or thing arising out of or in connection with the Contract or execution of the Works, unless the Contractor shall have included a claim in respect thereof in his Final Statement and (except in respect of matters or things arising after the issue of the Taking-Over Certificate in respect of the whole of the Works) in the Statement at Completion referred to in Sub- Clause 60.5.

**60.10 Time for Payment**

The amount due to the Contractor under any Interim Payment Certificate issued by the Engineer pursuant to this Clause, or to any other term of the Contract, shall, subject to Clause 47, be paid by the Employer to the Contractor within 28 days after such Interim Payment Certificate has been delivered to the Employer, or, in the case of the Final Payment Certificate referred to in Sub-Clause 60.8, within 56 days, after such Final Payment Certificate has been delivered to the Employer. In the event of the failure of the Employer to make payment within the times stated, the Employer shall pay to the Contractor interest at the rate stated in the Appendix to Tender upon all sums unpaid from the date by which the same should have been paid. The provisions of this Sub-Clause are without prejudice to the



Contractor's entitlement under Clause 69 or otherwise.

**61.1 Approval only by Defects Liability Certificate**

Only the Defects Liability Certificate, referred to in Clause 62, shall be deemed to constitute approval of the Works.

**62.1 Defects Liability Certificate**

The Contract shall not be considered as completed until a Defects Liability Certificate shall have been signed by the Engineer and delivered to the Employer, with a copy to the Contractor, stating the date on which the Contractor shall have completed his obligations to execute and complete the Works and remedy any defects therein to the Engineer's satisfaction.

The Defects Liability Certificate shall be given by the Engineer within 28 days after the expiration of the Defects Liability Period, or, if different defects liability periods shall become applicable to different Sections or parts of the Permanent Works, the expiration of the latest such period, or as soon thereafter as any works instructed, pursuant to Clause 49 and 50, have been completed to the satisfaction of the Engineer.

Provided that the issue of the Defects Liability Certificate shall not be a condition precedent to payment to the Contractor of the second portion of the Retention Money in accordance with the conditions set out in Sub-Clause 60.3.

**62.2 Unfulfilled Obligations**

Notwithstanding the issue of the Defects Liability Certificate the Contractor and the Employer shall remain liable for the fulfillment of any obligation incurred under the provisions of the Contract prior to the issue of the Defects Liability Certificate which remains unperformed at the time of such Defects Liability Certificate is issued and, for the purposes of determining the nature and extent of any such obligation, the Contract shall be deemed to remain in force between the parties to the Contract.

**Remedies**

**63.1 Default of Contractor**

If the Contractor is deemed by law unable to pay his debts as they fall due, or enters into voluntary or involuntary bankruptcy, liquidation or dissolution (other than a voluntary liquidation for the purposes of amalgamation or reconstruction), or becomes insolvent, or makes an arrangement with, or assignment in favour of, his creditors, or agrees to carry out the Contract under a committee of inspection of his creditors, or if a receiver, administrator, trustee or liquidator is appointed over any substantial part of his assets, or if, under any law or regulation relating to reorganization, arrangement or readjustment of debts, proceedings are commenced against the Contractor or resolutions passed in connection



with dissolution or liquidation or if any steps are taken to enforce any security interest over a substantial part of the assets of the Contractor, or if any act is done or event occurs with respect to the Contractor or his assets which, under any applicable law has a substantially similar effect to any of the foregoing acts or events, or if the Contractor has contravened Sub-Clause 3.1, or has an execution levied on his goods, or Contract, if the Engineer certifies to the Employer, with a copy to the Contractor, that, in his opinion, the Contractor:

- (a) has repudiated the Contract, or
- (b) without reasonable excuse has failed
- (i) to commence the Works in accordance with Sub-Clause 41.1,
  - (ii) to proceed with the Works, or any Section thereof, within 28 days after receiving notice pursuant to Sub-Clause 46.1,
- (c) has failed to comply with a notice issued pursuant to Sub-Clause 37.4 or an instruction issued pursuant to Sub-Clause 39.1 within 28 days after having received it
- (d) despite previous warning from the Engineer, in writing, is otherwise persistently or flagrantly neglecting to comply with any of his obligations under the Contract, or
- (e) has contravened Sub-Clause 4.1,

then the Employer may, after giving 14 days' notice to the Contractor, enter upon the Site and the Works and terminate the employment of the Contractor without thereby releasing the Contractor from any of his obligations or liabilities under the Contract, or affecting the rights and authorities conferred on the Employer or the Engineer by the Contract, and may himself complete the Works or may employ any other contractor to complete the Works. The Employer or such other contractor may use for such completion so much of the Contractor's Equipment, Temporary Works and materials as he or they may think proper.

### 63.2 Valuation at Date of Termination

The Engineer shall, as soon as may be practicable after any such entry and termination by the Employer, fix and determine expert, or by or after reference to the parties or after such investigation or enquiries as he may think fit to make or institute, and shall certify:

- (a) what amount (if any) had, at the time of such entry and termination, been reasonably earned by or would reasonably accrue to the Contractor in respect of work then actually done by him under the



Contract, and

- (b) the value of any of the said unused or partially used materials, any Contractor's Equipment and any Temporary Works.

### 63.3 Payment after Termination

If the Employer terminates the Contractor's employment under this Clause, he shall not be liable to pay to the Contractor any further amount (including damages) in respect of the Contract until the expiration of the Defects Liability Period and thereafter until the costs of execution, completion and remedying of any defects, damages for delay in completion (if any) and all other expenses incurred by the Employer have been ascertained and the amount thereof certified by the Engineer. The Contractor shall then be entitled to receive only such sum (if any) as the Engineer may certify would have been payable to him upon due completion by him after deducting the said amount. If such amount exceeds the sum which would have been payable to the Contractor on due completion by him, then the Contractor shall, upon demand, pay to the Employer the amount of such excess and it shall be deemed a debt due by the Contractor to the Employer and shall be recoverable accordingly.

### 63.4 Assignment of Benefit of Agreement

Unless prohibited by law, the Contractor shall, if so instructed by the Engineer within 14 days of such entry and termination referred to in Sub-Clause 63.1, assign to the Employer the benefit of any agreement for the supply of any goods or materials or services and/or for the execution of any work for the purposes of the Contract, which the Contractor may have entered into.

### 64.1 Urgent Remedial Work

If, by reason of any accident, or failure, or other event occurring to, in, or in connection with the Works, or any part thereof, either during the execution of the Works, or during the Defects Liability Period, any remedial or other work is, in the opinion of the Engineer, urgently necessary for the safety of the Works and the Contractor is unable or unwilling at once to do such work, the Employer shall be entitled to employ and pay other persons to carry out such work as the Engineer may consider necessary. If the work or repair so done by the Employer is work which, in the opinion of the Engineer, the Contractor was liable to do at his own cost under the Contract, then all costs consequent thereon or incidental thereto shall, after due consultation with the Employer and the Contractor, be determined by the Engineer and shall be recoverable from the Contractor by the Employer, and may be deducted by the Employer from any monies due or to become due to the Contractor and the Engineer shall notify the Contractor accordingly, with a copy to the Employer.



Provided that the Engineer shall, as soon after the occurrence of any such emergency as may be reasonably practicable, notify the Contractor thereof.

**Special Risks**

**65.1 No Liability for Special Risks**

Subject to due care and precaution and due diligence by the Contractor, the Contractor shall be under no liability whatsoever in consequence of any of the special risks referred to in Sub-Clause 65.2, whether by way of indemnity or otherwise, for or in respect of:

- (a) destruction of or damage to the Works, save to work condemned under the provisions of Clause 39 prior to the occurrence of any of the said special risks,
- (b) destruction of or damage to property, whether of the Employer or third parties, or
- (c) injury or loss of life.

**65.2 Special Risks**

The Special Risks are:

- (a) the risks defined under paragraphs (a), (c), (d) and (e) of Sub-Clause 20.4, and
- (b) the risks defined under paragraph (b) of Sub-Clause 20.4 insofar as these relate to the country in which the Works are to be executed.

**65.3 Damage to Works by Special Risks**

If the Works or any materials or Plant on or near or in transit to the Site, or any of the Contractor's Equipment, sustain destruction or damage by reason of any of the said special risks, the Contractor shall be entitled to payment in accordance with the Contract for any Permanent Works duly executed and for any materials or Plant so destroyed or damaged and, so far as may be required by the Engineer or as may be necessary for the completion of the Works, to payment for:

- (a) rectifying any such destruction or damage to the Works, and
- (b) replacing or rectifying such materials or Contractor's Equipment,

and the Engineer shall determine an addition to the Contract Price in accordance with Clause 52 (which shall in the case of the cost of replacement of Contractor's Equipment include the fair market value thereof as determined by the Engineer) and shall notify the Contractor accordingly, with a copy to the Employer.

**65.4 Projectile, Missile**

Destruction, damage, injury or loss of life caused by the explosion or impact, whenever and wherever occurring, of any mine, bomb, shell, grenade, or other projectile, missile, munitions, or explosive of war, shall be deemed to be a consequence of the said special risks.

**65.5 Increased Costs arising from Special Risks**

Save to the extent that the Contractor is entitled to payment under any other provision of the Contract, the Employer shall repay to the Contractor any costs of the execution of the Work (other than such as may be attributable to the cost of reconstructing work condemned under the provisions of Clause 39 prior to the occurrence of any special risk) which are howsoever attributable to or consequent on or the result of or in any way whatsoever connected with the said special risks, subject however to the provisions in this Clause hereinafter contained in regard to outbreak of war, but the Contractor shall, as soon as any such cost comes to his knowledge, forthwith notify the Engineer thereof. The Engineer shall, after due consultation with the Employer and the Contractor, determine the amount of the Contractor's costs in respect thereof which shall be added to the Contract Price and shall notify the Contractor accordingly, with a copy to the Employer.

**65.6 Outbreak of War**

If, during the currency of the Contract, there is an outbreak of war, whether war is declared or not, which, whether financially or otherwise, materially affects the execution of the Works, the Contractor shall, unless and until the Contract is terminated under the provisions of this Clause, continue to use his best endeavour to complete the execution of the Works. Provided that the Employer shall be entitled, at any time after such outbreak of war, to terminate the Contract by giving notice to the Contractor and, upon such notice being given, the Contract shall, except as to the rights of the parties under this clause and Clause 67, terminate, but without prejudice to the rights of either party in respect of any antecedent breach thereof.

**65.7 Removal of Contractor's Equipment on Termination**

If the Contract is terminated under the provisions of Sub-Clause 65.6, the Contractor shall, with all reasonable dispatch, remove from the Site all Contractor's Equipment and shall give similar facilities to his Subcontractors to do so.

**65.8 Payment if Contract Terminated**

If the Contract is terminated as aforesaid, the Contractor shall be paid by the Employer, insofar as such amounts or items have not already





been covered by payments on account made to the Contractor, for all work executed prior to the date of termination at the rates and prices provided in the Contract and in addition:

- (a) the amounts payable in respect of any preliminary items referred to in the Bill of Quantities, so far as the work or service comprised therein has been carried out or performed, and a proper portion of any such items which have been partially carried out or performed;
- (b) the cost of materials, Plant or goods reasonably ordered for the Works which have been delivered to the Contractor or of which the Contractor is legally liable to accept delivery, such materials, Plant or goods becoming the property of the Employer upon such payments being made by him;
- (c) a sum being the amount of any expenditure reasonably incurred by the Contractor in the expectation of completing the whole of the Works insofar as such expenditure has not been covered by any other payments referred to in this Sub-Clause;
- (d) any additional sum payable under the provisions of Sub-Clauses 65.3 and 65.5;
- (e) such proportion of the cost as may be reasonable, taking into account payments made or to be made for work executed, of removal of Contractor's Equipment under Sub-Clause 65.7 and, if required by the Contractor, return thereof to the Contractor's main plant yard in his country of registration or to other destination, at no greater cost; and
- (f) the reasonable cost of repatriation of all the Contractor's staff and workmen employed on or in connection with the Works at the time of such termination.

Provided that against any payment due from the Employer under this Sub-Clause, the Employer shall be entitled to be credited with any outstanding balances due from the Contractor for advances in respect of Contractor's Equipment, materials and Plant and any other sums which, at the date of termination, were recoverable by the Employer from the Contractor under the terms of Contract. Any sums payable under this Sub-Clause shall, after due consultation with the Employer and the Contractor, be determined by the Engineer who shall notify the Contractor accordingly, with a copy to the Employer.

#### **Release from Performance**

##### **66.1 Payment in Event of Release from Performance**

If any circumstance outside the control of both parties arises after the issue



of the Letter of Acceptance which renders it impossible or unlawful for either party to fulfill his or their contractual obligations, or under the law governing the Contract the parties are released from further performance, then the parties shall be discharged from the Contract, except as to their rights under this Clause and Clause 67 and without prejudice to the rights of either party in respect of any antecedent breach of the Contract, and the sum payable by the Employer to the Contractor in respect of the work executed shall be the same as that which would have been payable under Clause

65 if the Contract had been terminated under the provisions of Clause 65.

### Settlement of Disputes

#### 67.1 Employer's Decision

If a dispute of any kind whatsoever arises between the Employer and the Contractor in connection with, or arising out of, the Contract or the execution of the Works, whether during the execution of the Works or after their completion and whether before or after repudiation or other termination of the Contract, including any dispute as to any opinion, instruction, determination, certificate or valuation of the Engineer, the matter in dispute shall, in the first place, be referred not later than 30 days in writing to the MD/CEO of the Employer or his nominee, with a copy to the other party. Such reference shall state that it is made pursuant to this Clause. Not later than

30 days after the day on which he received such reference the MD/CEO or his nominee shall give notice of his decision to the Employer and the Contractor. Such decision shall state that it is made pursuant to this Clause.

Unless the Contract has already been repudiated or terminated, the Contractor shall, in every case, continue to proceed with the Works with all due diligence and the Contractor and the Employer shall give effect forthwith to every such decision of the MD/CEO or his nominee unless and until the same shall be revised, as hereinafter provided, in an amicable settlement or an arbitral award.

If either the Employer or the Contractor be dissatisfied with any decision of the MD/CEO or his nominee, or if the MD/CEO or his nominee fails to give notice of his decision on or before the 30 days on which he received the reference, then either the Employer or the Contractor may, on or before the 30<sup>th</sup> day after the day on which he received notice of such decision, or on or before the 30<sup>th</sup> day after the day on which the said period of 30th days expired, as the case may be, give notice to the other party, with a copy for information to the Engineer & Employer, of his intention to commence arbitration, as hereinafter provided, as to the matter in dispute. Such notice shall establish the entitlement of the party giving the same to commence arbitration,

as hereinafter provided, as to such dispute and, subject to Sub-Clause



67.4, no arbitration in respect thereof may be commenced unless such notice is given.

If the MD/CEO or his nominee as the case may be has given notice of his decision as to a matter in dispute to the Employer and the Contractor and no notice of intention to commence arbitration as to such dispute has been given by either the Employer or the Contractor on or before the 30<sup>th</sup> day after the day on which the parties received notice as to such decision, the said decision shall become final and binding upon the Employer and the Contractor.

**67.2 Amicable Settlement**

Where notice of intention to commence arbitration as to a dispute has been given in accordance with Sub-Clause 67.1, the parties shall attempt to settle such dispute amicably before the commencement of arbitration. Provided that, unless the parties otherwise agree, arbitration may be commenced on or after 30<sup>th</sup> day after the day on which notice of intention to commence arbitration of such dispute was given, even if no attempt at amicable settlement thereof has been made.

**67.3 Arbitration**

Any dispute in respect of which:

- (a) the decision, if any, of the MD/CEO or his nominee has not become final and binding pursuant to Sub-Clause 67.1, and
- (b) amicable settlement has not been reached within the period stated in Sub-Clause 67.2,

shall be finally settled, unless otherwise specified in the Contract, under the Arbitration Act, 1940. The said arbitrator/s shall have full power to open up, review and revise any decision, opinion, instruction, determination, certificate or valuation of the MD/CEO or his nominee related to the dispute.

Neither party shall be limited in the proceedings before such arbitrator/s to the evidence or arguments put before the MD/CEO or his nominee for the purpose of obtaining his said decision pursuant to Sub-Clause 67.1. No such decision shall disqualify the Engineer from being called as a witness and giving evidence before the arbitrator/s on any matter whatsoever relevant to the dispute.

Arbitration may be commenced prior to or after completion of the Works, provided that the obligations of the Employer, the Engineer and the Contractor shall not be altered by reason of the arbitration being conducted during the progress of the Works.



67.4 **Final and Binding Decision**

Where neither the Employer nor the Contractor has given notice of intention to commence arbitration of a dispute within the period stated in Sub-Clause 67.1 and the related decision shall become final and binding.

**Notice**

68.1 **Notices to Contractor**

All certificates, notices or instructions to be given to the Contractor by the Employer or the Engineer under the terms of the Contract shall be sent by post, cable, telex or facsimile transmission to or left at the Contractor's principal place of business or such other address as the Contractor shall nominate for that purpose.

68.2 **Notice to Employer and Engineer**

Any notice to be given to the Employer or to the Engineer under the terms of the Contract shall be sent by post, cable, telex or facsimile transmission to or left at the respective addresses nominated for that purpose in Part II of these Conditions.

68.3 **Change of Address**

Either party may change a nominated address to another address in the country where the Works are being executed by prior notice to the other party, with a copy to the Engineer, and the Engineer may do so by prior notice to both parties.

**Default of Employer**

69.1 **Default of Employer**

In the event of the Employer:

- (a) failing to pay to the Contractor the amount due under any certificate of the Engineer within 28 days after the expiry of the time stated in Sub-Clause 60.10 Within which payment is to be made, subject to any deduction that the Employer is entitled to make under the Contract,
- (b) interfering with or obstructing or refusing any required approval to the issue of any such certificate,
- (c) becoming bankrupt or, being a company, going into liquidation, other than for the purpose of a scheme of reconstruction or amalgamation, or



- (d) giving notice to the Contractor that for economic reasons it is impossible for him to continue to meet his contractual obligations, the Contractor shall be entitled to terminate his employment under the Contract by giving notice to the Employer, with a copy to the Engineer. Such termination shall take effect 14 days after the giving of the notice.

**69.2 Removal of Contractor's Equipment**

Upon the expiry of the 14 days' notice referred to in Sub-Clause 69.1, the Contractor shall, notwithstanding the provisions of Sub-Clause 54.1, with all reasonable dispatch, remove from the Site all Contractor's Equipment brought by him thereon.

**69.3 Payment on Termination**

In the event of such termination the Employer shall be under the same obligations to the Contractor in regard to payment as if the Contract had been terminated under the provisions of Clause 65.

**69.4 Contractor's Entitlement to Suspend Work**

Without prejudice to the Contractor's entitlement to interest under Sub-Clause 60.10 and to terminate under Sub-Clause 69.1, the Contractor may, if the Employer fails to pay the Contractor the amount due under any certificate of the Engineer within 28 days after the expiry of the time stated in Sub-Clause 60.10 within which payment is to be made, subject to any deduction that the Employer is entitled to make under the Contract, after giving 28 days' prior notice to the Employer, with a copy to the Engineer, suspend work or reduce the rate of work.

If the Contractor suspends work or reduces the rate of work in accordance with the provisions of this Sub-Clause and thereby suffers delay or incurs costs the Engineer shall, after due consultation with the Employer and the Contractor, determine:

- (a) any extension of time to which the Contractor is entitled under Clause 44, and  
(b) the amount of such costs, which shall be added to the Contract Price, and

shall notify the Contractor accordingly, with a copy to the Employer.

**69.5 Resumption of Work**

Where the Contractor suspends work or reduces the rate of work, having given notice in accordance with Sub-Clause 69.4, and the Employer subsequently pays the amount due, including interest pursuant to Sub-Clause 60.10, the Contractor's entitlement under Sub-Clause 69.1 shall, if notice of termination has not been given, lapse and the Contractor shall

  
Muhammad Muaz  
C.E (P/Line)  
Ext: 5065



resume normal working as soon as is reasonably possible.

**Changes in Cost and Legislation**

**70.1 Increase or Decrease of Cost (Clause-70 is deleted entirely).**

There shall be added to or deducted from the Contract Price such sums in respect of rise or fall in the cost of labour and/or materials or any other matters affecting the cost of the execution of the Works as may be determined in accordance with part II of these Conditions.

**70.2 Subsequent Legislation**

If, after the date 28 days prior to the latest date for submission of tenders for the Contract there occur in the country in which the Works are being or are to be executed changes to any National or State Statute, Ordinance, Decree or other Law or any regulation or bye-law of any local or other duly constituted authority, or the introduction of any such State Statute, Ordinance, Decree, Law, regulation or bye-law which causes additional or reduced cost to the Contractor, other than under Sub-Clause 70.1, in the execution of the Contract, such additional or reduced cost shall, after due consultation with the Employer and the Contractor, be determined by the Engineer and shall be added to or deducted from the Contract Price and the Engineer shall notify the Contractor accordingly, with a copy to the Employer.

**Currency and Rates of Exchange**

**71.1 Currency Restrictions**

If, after the date 28 days prior to the latest date for submission of tenders for the Contract, the Government or authorized agency of the Government of the country in which the Works are being or are to be executed imposes currency restrictions and/or transfer of currency restrictions in relation to the currency or currencies in which the Contract Price is to be paid, the Employer shall reimburse any loss or damage to the Contractor arising therefrom, without prejudice to the right of the Contractor to exercise any other rights or remedies to which he is entitled in such event.

  
**Muhammad Muaz**  
C.E (P/Line)  
Ext: 5065

**72.1 Rates of Exchange**

Where the Contract provides for payment in whole or in part to be made to the Contractor in foreign currency or currencies, such payment shall not be subject to variations in the rate or rates of exchange between such specified foreign currency or currencies and the currency of the country in which the Works are to be executed.

**72.2 Currency Proportions**

Where the Employer has required the Tender to be expressed in a single currency but with payment to be made in more than one currency and the Contractor has stated the proportions or amounts of other currency or currencies in which he requires payment to be made, the rate or rates of exchange applicable for calculating the payment of such proportions or amounts shall, unless otherwise stated in Part II of these Conditions, be those prevailing, as determined by the Central Bank of the country in which the Works are to be executed, on the date 28 days prior to the latest date for the submission of tenders for the Contract, as has been notified to the Contractor by the Employer prior to the submission of tenders or as provided for in the Tender.

**72.3 Currencies of Payment for Provisional Sums**

Where the Contract provides for payment in more than one currency, the proportions or amounts to be paid in foreign currencies in respect of Provisional Sums shall be determined in accordance with the principles set forth in Sub-Clauses 72.1 and 72.2 as and when these sums are utilised in whole or in part in accordance with the provisions of Clauses 58 and 59.

**Muhammad Muaz**  
C.E (P/Line)  
Ext: 5065



**PART – II**  
**PARTICULAR CONDITIONS OF CONTRACT**





**PART II  
PARTICULAR CONDITIONS OF CONTRACT**

**(Mandatory Provisions not to be Amended / Substituted except as instructed by PEC)**

**1.1 Definitions**

- (a) (i) The Employer is Oil & Gas Development Company Limited (OGDCL), Islamabad, its legal successors and assignees.
- (a) (iv) The Engineer is the person / consultant appointed, from time to time, by the Employer or any other competent person appointed by the Employer, and notified to the Contractor, to act in replacement of the Engineer. Provided always that except in cases of professional misconduct, the outgoing Engineers is to formulate his certifications/recommendations in relation to all outstanding matters, disputes and claims relating to the execution of the Works during his tenure.

The following paragraph is added:

- (a)(vi) "Bidder or Tendered" means any person or persons, company, corporation, firm or joint venture submitting a Bid or Tender.

- (b)(v) The following is added at the end of the paragraph:

The word "Tender" is synonymous with "Bid" and the word "Tender Documents" with "Bidding Documents".

The following paragraph is added:

- (b)(ix) "Programme" means the programme to be submitted by the Contractor in accordance with Sub-Clause 14.1 and any approved revisions thereto.

- (e)(i) The text is deleted and substituted with the following:

"Contract Price" means the sum stated in the Letter of Acceptance as payable to the Contractor for the execution and completion of the Works subject to such additions thereto or deductions there from as may be made and remedying of any defects therein in accordance with the provisions of the Contract.

**2.1 Engineer's Duties and Authority**

With reference to Sub-Clause 2.1(b), the following provisions shall also apply;

  
**Muhammad Muaz**  
C.E (P/Line)  
Ext: 5065



The Engineer shall obtain the specific approval of the Employer before carrying out his duties in accordance with the following Clauses:

- (i) Consenting to the sub-letting of any part of the Works under Sub-Clause 4.1 "Subcontracting".
- (ii) Certifying additional cost determined under Sub-Clause 12.2 "Not Foreseeable Physical Obstructions or Conditions".
- (iii) Any action under Clause 10 "Performance Security" and Clauses 21,23,24 & 25 "Insurance" of sorts.
- (iv) Any action under Clause 40 "Suspension".
- (v) Any action under Clause 44 "Extension of Time for Completion".
- (vi) Any action under Clause 47 "Liquidated Damages for Delay".
- (vii) Issuance of "Taking Over Certificate" under Clause
48. (viii) Issuing a Variation Order under Clause 51, except:
  - a) in an emergency\* situation, as stated here below, or
  - b) if such variation would increase the Contract Price by less than the amount stated in the Appendix-A to Bid.
- (ix) Fixing rates or prices under Clause 52.
- (x) Extra payment as a result of Contractor's claims under Clause 53.
- (xi) Release of Retention Money to the Contractor under Sub-Clause 60.3 "Payment of Retention Money".
- (xii) Issuance of "Final Payment Certificate" under Sub-Clause 60.8.
- (xiii) Issuance of "Defect Liability Certificate" under Sub-Clause 62.1.
- (xiv) Any change in the ratios of Contract currency proportions and payments thereof under Clause 72 "Currency and Rate of Exchange".

(Note: Employer may further vary according to need of the project)



\* (If in the opinion of the Engineer an emergency occurs affecting the safety of life or of the Works or of adjoining property, the Engineer may, without relieving the Contractor of any of his duties and responsibilities under the Contract, instruct the Contractor to execute all such work or to do all such things as may, in the opinion of the Engineer, be necessary to abate or reduce the risk. The Contractor shall forthwith comply with any such instruction of the Engineer. The Engineer shall determine an addition to the Contract Price, in respect of such instruction, in accordance with Clause 52 and shall notify the Contractor accordingly, with a copy to the Employer.)

## 2.2 Engineer's Representative

The following paragraph is added:

The Employer shall ensure that the Engineer's Representative is a professional engineer as defined in the Pakistan Engineering Council Act 1975 (V of 1976)

The following Sub-Clauses 2.7 and 2.8 are added:

## 2.7 Engineer Not Liable

Approval, reviews and inspection by the Engineer of any part of the Works does not relieve the Contractor from his sole responsibility and liability for the supply of materials, plant and equipment for construction of the Works and their parts in accordance with the Contract and neither the Engineer's authority to act nor any decision made by him in good faith as provided for under the Contract whether to exercise or not to exercise such authority shall give rise to any duty or responsibility of the Engineer to the Contractor, any Subcontractor, any of their representatives or employees or any other person performing any portion of the Works.

## 2.8 Replacement of the Engineer

"If the Employer intends to replace the Engineer, the Employer shall, not less than 14 days before the intended date of replacement, give notice to the Contractor, of the name, address and relevant experience of the intended replacement Engineer. The Employer shall not replace the Engineer with a person against whom the Contractor raises reasonable objection by notice to the Employer, with supporting particulars."



### 5.1 Language(s) and Law

- (a) The Contract Documents shall be drawn up in the English language.
- (b) The Contract shall be subject to the Laws of Islamic Republic of Pakistan.

### 5.2 Priority of Contract Documents

In case of discrepancies between drawings, those of larger scale shall govern unless they are superseded by a drawing of later date regardless of scale. All Drawings and Specifications shall be interpreted in conformity with the Contract and these Conditions. Addendum, if any, shall be deemed to have been incorporated at the appropriate places in the documents forming the Contract.

The following Sub-Clauses 6.6 and 6.7 are added:

### 6.6 Shop Drawings

The Contractor shall submit to the Engineer for review 3 copies of all shop and erection drawings applicable to this Contract as per provision of relevant Sub-Clause of the Contract.

Review and approval by the Engineer shall not be construed as a complete check but will indicate only that the general method of construction and detailing is satisfactory and that the Engineer's review or approval shall not relieve the Contractor of any of his responsibilities under the Contract.



## 6.7 As-Built Drawings

At the completion of the Works under the Contract, the Contractor shall furnish to the Engineer 6 copies and one reproducible of all drawings amended to conform with the Works as built. The price of such Drawings shall be deemed to be included in the Contract Price.

## 10.1 Performance Security

The text is deleted and substituted with the following:

The Contractor shall provide Performance Security to the Employer in the prescribed form as per Employer Format. The said Security shall be furnished or caused to be furnished by the Contractor within 14 days or the time stipulated by the Employer after the receipt of the Letter of Acceptance. The maximum amount of Performance Security shall be equal to 10% of the total Contract Price stated in the Letter of Acceptance. Such Security shall be in the form of bank guarantee from any Scheduled Bank in Pakistan.

The cost of complying with requirements of this Sub-Clause shall be borne by the Contractor

The following Sub-Clause 10.4 is added:

## 10.4 Performance Security Binding on Variations and Changes

The Performance Security shall be binding irrespective of changes in the quantities or variations in the Works or extensions in Time for Completion of the Works which are granted or agreed upon under the provisions of the Contract.

## 14.1 Programme to be submitted

The programme shall be submitted within 42 days from the date of receipt of Letter of Acceptance, which shall be in the form of:

- i) a Bar Chart identifying the critical activities.
- ii) a CPM identifying the critical path/activities.  
*(Employer to select appropriate one)*



### 14.3 Cash Flow Estimate to be Submitted

The detailed Cash Flow Estimate shall be submitted within 21 days from the date of receipt of Letter of Acceptance

The following Sub-Clause 14.5 is added:

### 14.5 Detailed Programme and Monthly Progress Report

a) For purposes of Sub-Clause 14.1, the Contractor shall submit to the Engineer detailed programme for the following:

- (1) Execution of Works; (2) Labour Employment;
- (3) Local Material Procurement; (4) Material Imports, if any; and
- (5) Other details as required by the Engineer.

(b) During the period of the Contract, the Contractor shall submit to the Engineer not later than the 8th day of the following month, 10 copies each of Monthly Progress Reports covering:

- (1) A Construction Schedule indicating the monthly progress in percentage;
- (2) Description of all work carried out since the last report;
- (3) Description of the work planned for the next 56 days sufficiently detailed to enable the Engineer to determine his programme of inspection and testing;
- (4) Monthly summary of daily job record;
- (5) Photographs to illustrate progress ;and
- (6) Information about problems and difficulties encountered, if any, and proposals to overcome the same.

(c) During the period of the Contract, the Contractor shall keep a daily record of the work progress, which shall be made available to the Engineer as and when requested. The daily record shall include particulars of weather conditions, number of men working, deliveries of materials, quantity, location and assignment of Contractor's equipment.

The following Sub-Clauses 15.2 and 15.3 are added:

### 15.2 Language Ability of Contractor's Representative

The Contractor's authorized representative shall be fluent in the English language. Alternately an interpreter with ability of English language shall be provided by the Contractor on full time basis.



### 15.3 Contractor's Representative

The Contractor's authorized representative and his other professional engineers working at Site shall register themselves with the Pakistan Engineering Council.

The Contractor's authorized representative at Site shall be authorized to exercise adequate administrative and financial powers on behalf of the Contractor so as to achieve completion of the Works as per the Contract. The following Sub-Clauses 16.3 and 16.4 are added:

### 16.3 Language Ability of Superintending Staff of Contractor

A reasonable proportion of the Contractor's superintending staff shall have a working knowledge of the English language. If the Contractor's superintending staffs are not fluent in English language, the Contractor shall make competent interpreters available during all working hours in a number deemed sufficient by the Engineer.

### 16.4 Employment of Local Personnel

The Contractor is encouraged, to the extent practicable and reasonable, to employ staff and labour from sources within Pakistan.

The following Sub-Clauses 19.3 and 19.4 are added:

### 19.3 Safety Precautions

In order to provide for the safety, health and welfare of persons, and for prevention of damage of any kind, all operations for the purposes of or in connection with the Contract shall be carried out in compliance with the Safety Requirements of the Government of Pakistan with such modifications thereto as the Engineer may authorize or direct and the Contractor shall take or cause to be taken such further measures and comply with such further requirements as the Engineer may determine to be reasonably necessary for such purpose.

The Contractor shall make, maintain and submit reports to the Engineer concerning safety, health and welfare of persons and damage to property, as the Engineer may from time to time prescribe.



#### 19.4 Lighting Work at Night

In the event of work being carried out at night, the Contractor shall at his own cost, provide and maintain such good and sufficient light as will enable the work to proceed satisfactorily and without danger. The approaches to the Site and the Works where the night-work is being carried out shall be sufficiently lighted. All arrangement adopted

for such lighting shall be to the satisfaction of the Engineer's Representative.

#### 20.4 Employer's Risks

The Employer's risks are:

Notwithstanding anything contained (in GCC 20.4), the Employer shall not be responsible, compensate or bear any kind of risk/liability whatsoever in nature.

#### 21.1 Insurance of Works and Contractor's Equipment

Insurance will be the liability of the Contractor in any of the case.

#### 21.3 Responsibility for Amounts not Recovered

The text is deleted and substituted with the following:

Any amount not insured or not recovered from the insurers shall be borne by the Contractor in accordance with their responsibility.

#### 21.4 Exclusions

The text is deleted and substituted with the following:

There shall be no obligation for the insurances in Sub-Clause 21.1 to include loss or damage caused by the risks listed under Sub-Clause 20.4 paras (a) to (h).

The following Sub-Clause 25.5 is added.

#### 21.5 Taxes

Any taxes, duties, fees, levies and other relevant charges, present or future, assessed or payable outside Pakistan by the Contractor and/or by the expatriate





personnel deputed by Contractor in connection with the services performed under the contract shall be the exclusive responsibility of the Contractor.

Any taxes, duties, fees, levies and other relevant charges, present or future, assessed or payable in Pakistan by the Contractor and/or by the expatriate personnel deputed by the Contractor in connection with the services performed under the contract shall be the exclusive responsibility of the Contractor.

The Contractor shall be responsible and pay all taxes on its income outside and in particular on its income in Pakistan under the Contract and under the laws of Pakistan. Employer shall have the right, as provided under the laws of Pakistan to meet its obligations and in particular to deduct from the payment due to the Contractor, income tax at source at the rates prevailing from time to time, from the invoiced amounts, or such reduced rates fixed by the taxation authorities for the Contractor on production of documentary evidence by the Contractor and pay such amount to appropriate authorities.

The Contractor shall also be responsible for any income taxes levied on the Contractor's expatriate personnel, under the laws of Pakistan and for all social security issuances and other contributions for the Contractor's expatriate personnel regardless of whether such contributions are levied on employer or employee or both in Pakistan.

The Contractor shall keep Employer duly informed about the steps taken by the Contractor in order to meet its obligations under the contract and provide the necessary documents to Employer in this connection.

The Contractor shall indemnify Employer against any claim, which might occur due to non-compliance by the Contractor of any legal obligation regarding the taxes, duties, fees, levies, or other charges, including taxes on income in Pakistan and any other payments to the Government or Governmental agencies.

## **22.2 Exceptions**

The sub clause 22.2(d) is deleted.

## **22.3 Indemnity by the Employer**

The clause is deleted in its entirety.

## **23.1 Third Party Insurance (Including Employer's Property)**

The clause will be read as follows:



The Contractor shall, without limiting his or the Employer's obligation and responsibilities under Clause 22, insure, in the joint names of the Contractor and the Employer, against liabilities for death of or injury to any person.

**25.1 Evidence and Terms of Insurances**

Number of days in the text of this clause shall be read as 30 days instead of 84 days.

**25.3 Remedy on Contractor Failure to Insure**

Delete the text and substitute with the following

The Contractor shall effect and keep in force all insurances required under the contract. The Employer shall not effect any kind of insurance on behalf of this project.

**25.4 Compliance with Policy Conditions**

Delete the text and substitute with the following:

“In the event that the Contractor fails to comply with conditions imposed by the insurance policies effected pursuant to the contract, the Contractor shall indemnify the other against all losses and claims arising from such failure.”

**25.5 Insurance Company**

The Contractor shall be obliged to place all insurances relating to the Contract (including, but not limited to, the insurances referred to in Clauses 21, 23 and 24) with either National Insurance Company of Pakistan or any other insurance company operating in Pakistan and acceptable to the Employer.

Costs of such insurances shall be borne by the Contractor. The following Sub-

Clause 31.3 is added:

**31.3 Co-operation with other Contractors**

During the execution of the Works, the Contractor shall co-operate fully with other contractors working for the Employer at and in the vicinity of the Site and also shall provide adequate precautionary facilities not to make himself a nuisance to local residents and other contractors.



The following Sub-Clauses 34.2 to 34.12 are added:

**34.2 Rates of Wages and Conditions of Labour**

The Contractor shall pay rates of wages and observe conditions of labour not less favorable than those established for the trade or industry where the work is carried out. In the absence of any rates of wages or conditions of labour so established, the Contractor shall pay rates of wages and observe conditions of labour which are not less favorable than the general level of wages and conditions observed by other employers whose general circumstances in the trade or in industry in which the Contractor is engaged are similar.

**34.3 Employment of Persons in the Service of Others**

The Contractor shall not recruit his staff and labour from amongst the persons in the services of the Employer or the Engineer; except with the prior written consent of the Employer or the Engineer, as the case may be.

**34.4 Housing for Labour**

Save insofar as the Contract otherwise provides, the Contractor shall provide and maintain such housing accommodation and amenities as he may consider necessary for all his supervisory staff and labour, employed for the purposes of or in connection with the Contract including all fencing, electricity supply, sanitation, cookhouses, fire prevention, water supply and other requirements in connection with such housing accommodation or amenities. On completion of the Contract, these facilities shall be handed over to the Employer or if the Employer so desires, the temporary camps or housing provided by the Contractor shall be removed and the Site reinstated to its original condition, all to the approval of the Engineer.

**34.5 Health and Safety**

Due precautions shall be taken by the Contractor, and at his own cost, to ensure the safety of his staff and labour at all times throughout the period of the Contract. The Contractor shall further ensure that suitable arrangements are made for the prevention of epidemics and for all necessary welfare and hygiene requirements.

**34.6 Epidemics**

In the event of any outbreak of illness of an epidemic nature, the Contractor shall comply with and carry out such regulations, orders and requirements as



may be made by the Government, or the local medical or sanitary authorities, for purpose of dealing with and overcoming the same.

**34.7 Supply of Water**

The Contractor shall, so far as is reasonably practicable, having regard to local conditions, provide on the Site, to the satisfaction of the Engineer or his representative, adequate supply of drinking and other water for the use of his staff and labour.

**34.8 Alcoholic Liquor or Drugs**

The Contractor shall not, otherwise than in accordance with the Statutes, Ordinances and Government Regulations or Orders for the time being in force, import, sell, give, barter or otherwise dispose of any alcoholic liquor or drugs, or permit or suffer any such importation, sale, gift, barter or disposal by his Subcontractors, agents, staff or labour.

**34.9 Arms and Ammunition**

The Contractor shall not give, or otherwise dispose of to any person or persons, any arms or ammunition of any kind or permit or suffer the same as aforesaid.

**34.10 Festivals and Religious Customs**

The Contractor shall in all dealings with his staff and labour have due regard to all recognized festivals, days of rest and religious and other customs.

**34.11 Disorderly Conduct**

The Contractor shall at all times take all reasonable precautions to prevent any unlawful, riotous or disorderly conduct by or amongst staff and labour and for the preservation of peace and protection of persons and property in the neighborhood of the Works against the same.

**34.12 Compliance by Subcontractors**

The Contractor shall be responsible for compliance by his Subcontractors of the provisions of this Clause.

The following Sub-Clauses 35.2 and 35.3 are added:

**35.2 Records of Safety and Health**



The Contractor shall maintain such records and make such reports concerning safety, health and welfare of persons and damage to property as the Engineer may from time to time prescribe.

### **35.3 Reporting of Accidents**

The Contractor shall report to the Engineer details of any accident as soon as possible after its occurrence. In the case of any fatality or serious accident, the Contractor shall, in addition, notify the Engineer immediately by the quickest available means.

The following Sub-Clause 36.6 is added:

### **36.6 Use of Pakistani Materials and Services**

The Contractor shall , so far as may be consistent with the Contract, make the maximum use of materials, supplies, plant and equipment indigenous to or produced or fabricated in Pakistan and services, available in Pakistan provided such materials, supplies, plant, equipment and services shall be of required standard.

### **41.1 Commencement of Works**

The text is deleted and substituted with the following:

The Contractor shall commence the Works on Site within the period named in Appendix-A to Bid from the date of receipt by him from the Engineer of a written Notice to Commence. Thereafter, the Contractor shall proceed with the Works with due expedition and without delay.

### **48.2 Taking Over of Sections or Parts**

For the purposes of para (a) of this Sub-Clause, separate Times for Completion shall be provided in the Appendix-A to Bid "Special Stipulations". See attached samples for "Final Acceptance Certificate" (Attachment-I) and "Provisional Acceptance Certificate" (Attachment-II).

### **49.5 Extensions of Defects Liability Period**

The provisions of this Sub-Clause shall apply to all replacements or renewals of plant and equipment carried out by the Contractor to remedy defects and damage as if the replacements and renewals had been taken over on the date they were completed. The Defects Liability Period for the Works shall be extended by a period equal to the period during which the Works cannot be used by reason of a defect or damage. If only a part of the Works is affected the Defects Liability Period shall be extended only for that part. In neither case shall



the Defects Liability Period extend beyond two (2) years from the date of taking over.

#### **51.2 Instructions for Variations**

At the end of the first sentence, after the word "Engineer", the words "in writing" are added.

#### **52.1 Valuation of Variations**

In the tenth line, after the words "Engineer shall" the following is added: within a period not exceeding one-eighth of the completion time subject to a minimum of 56 days from the date of disagreement whichever is later.

#### **53.4 Failure to Comply**

This Sub-Clause is deleted in its entirety.

#### **54.3 Customs Clearance**

(Employer may vary this Sub-Clause)

#### **54.5 Conditions of Hire of Contractor's Equipment**

The following paragraph is added:

The Contractor shall, upon request by the Engineer at any time in relation to any item of hired Contractor's Equipment, forthwith notify the Engineer in writing the name and address of the Owner of the equipment and shall certify that the agreement for the hire thereof contains a provision in accordance with the requirements set forth above.

The following Sub-Clauses 59.4 & 59.5 are added:

#### **59.4 Payments to Nominated Subcontractors**

The Contractor shall pay to the nominated Subcontractor the amounts which the Engineer certifies to be due in accordance with the subcontract. These amounts plus other charges shall be included in the Contract Price in accordance with Clause 58 [Provisional Sums], except as stated in Sub-Clause 59.5 [Certification of Payments].

#### **59.5 Certification of Payments & Nominated Subcontractors**

Before issuing a Payment Certificate which includes an amount payable



to a nominated Subcontractor, the Engineer may request the Contractor to supply reasonable evidence that the nominated Subcontractor has received all amounts due in accordance with previous Payment Certificates, less applicable deductions for retention or otherwise. Unless the Contractor:

- a) Submits reasonable evidence to the Engineer, or
- b)
  - i) satisfies the Engineer in writing that the Contractor is reasonably entitled to withhold or refuse to pay these amounts, and
  - ii) Submits to the Engineer reasonable evidence that the nominated Subcontractor has been notified of the Contractor's entitlement,

then the Employer may (at his sole discretion) pay direct to the nominated Subcontractor, part or all of such amounts previously certified (less applicable deductions) as are due to the nominated Subcontractor and for which the Contractor has failed to submit the evidence described in subparagraphs (a) or (b) above. The Contractor shall then repay, to the Employer, the amount which the nominated Subcontractor was directly paid by the Employer.

#### 60.1 Monthly Statements

In the first line after the word "shall", the following is added:

"on the basis of the joint measurement of work done under Clause 56.1,"

In Para (c) the words "the Appendix to Tender" are deleted and substituted with the words "Sub-Clause 60.11 (a)(6) hereof".  
(in case Clause 60.11 is applicable)

#### 60.2 Monthly Payments

In the first line, "28" is substituted by "14". The following Sub-Clause 60.11 is added:

##### 60.11 Secured Advance on Materials

- a) The Contractor shall be entitled to receive from the Employer Secured Advance against an indemnity bond acceptable to the Employer of such sum as the Engineer may consider proper in respect of non-perishable materials brought at the Site but not yet incorporated in the Permanent Works provided that:
  - (1) The materials are in accordance with the Specifications for



the Permanent Works;

- (2) Such materials have been delivered to the Site and are properly stored and protected against loss or damage or deterioration to the satisfaction of the Engineer but at the risk and cost of the Contractor;
  - (3) The Contractor's records of the requirements, orders, receipts and use of materials are kept in a form approved by the Engineer, and such records shall be available for inspection by the Engineer;
  - (4) The Contractor shall submit with his monthly statement the estimated value of the materials on Site together with such documents as may be required by the Engineer for the purpose of valuation of materials and providing evidence of ownership and payment therefore;
  - (5) Ownership of such materials shall be deemed to vest in the Employer and these materials shall not be removed from the Site or otherwise disposed of without written permission of the Employer; and
  - (6) The sum payable for such materials on Site shall not exceed 75 % of the (i) landed cost of imported materials, or (ii) ex-factory / ex-warehouse price of locally manufactured or produced materials, or (iii) market price of other materials.
- (b) The recovery of Secured Advance paid to the Contractor under the above provisions shall be effected from the monthly payments on actual consumption basis.

#### 60.12 Financial Assistance to Contractor

Financial assistance shall be made available to the Contractor by the Employer by adopting any one of the following three Alternatives:

##### Alternative One: Mobilization Advance

- (a) An interest-free Mobilization Advance up to 10 % of the Contract Price stated in the Letter of Acceptance shall be paid by the Employer to the Contractor in two equal parts upon submission by the Contractor of a Mobilization Advance Guarantee for the full amount of the Advance in the specified form from a Scheduled Bank in Pakistan.





- (1) First part within 14 days after signing of the Contract Agreement or date of receipt of Engineer's Notice to Commence, whichever is earlier; and
- (2) Second part within 42 days from the date of payment of the first part, subject to the satisfaction of the Engineer as to the state of mobilization of the Contractor.

(b) This Advance shall be recovered in six equal installments.

### 63.1 Default of Contractor

The following para is added at the end of the Sub-Clause:

Provided further that in addition to the action taken by the Employer against the Contractor under this Clause, the Employer may also refer the case of default of the Contractor to Pakistan Engineering Council for punitive action under the Construction and Operation of Engineering Works Bye-Laws 1987, as amended from time to time.

### 65.2 Special Risks

The text is deleted and substituted with the following:

The Special Risks are the risks defined under Sub-Clause 20.4 sub paragraphs (a) to (h).

### 67.3 Arbitration

In the sixth to eight lines, the words "shall be finally settled ..... appointed under such Rules" are deleted and substituted with the following:

shall be finally settled under the provisions of the Arbitration Act, 1940 as amended or any statutory modification or re-enactment thereof for the time being in force.

The following paragraph is added:

The place of arbitration shall be Islamabad, Pakistan.

### 68.1 Notice to Contractor

The following paragraph is added:

For the purposes of this Sub-Clause, the Contractor shall, immediately after



receipt of Letter of Acceptance, intimate in writing to the Employer and the Engineer by registered post, the address of his principal place of business or any change in such address during the period of the Contract.

**68.2 Notice to Employer and Engineer**

For the purposes of this Sub-Clause, the respective address are:

- a) The Employer:  
**OIL & GAS DEVELOPMENT COMPANY LIMITED, ISLAMABAD**
- b) The Engineer:  
The person appointed from time to time by the Employer.

**70.1 Increase or Decrease of Cost**

Sub-Clause 70.1 is deleted in its entirety

**(a) Other Changes in Cost**

To the extent that full compensation for any rise or fall in costs to the Contractor is not covered by the provisions of this or other Clauses in the Contract, the unit rates and prices included in the Contract shall be deemed to include amounts to cover the contingency of such other rise or fall of costs.

**73.1 Payment of Income Tax**

The Contractor, Subcontractors and their employees shall be responsible for payment of all their income tax, super tax and other taxes on income arising out of the Contract and the rates and prices stated in the Contract shall be deemed to cover all such taxes.

**73.2 Customs Duty & Taxes**

(Employer may incorporate provisions where applicable)

**74.1 Integrity Pact**

If the Contractor or any of his Subcontractors, agents or servants is found to have violated or involved in violation of the Integrity Pact signed by the Contractor as Appendix-L to his Bid, then the Employer shall be entitled to:

- (a) recover from the Contractor an amount equivalent to ten times the sum of any commission, gratification, bribe, finder's fee or kickback



- given by the Contractor or any of his Subcontractors, agents or servants;
- (b) terminate the Contract; and
  - (c) recover from the Contractor any loss or damage to the Employer as a result of such termination or of any other corrupt business practices of the Contractor or any of his Subcontractors, agents or servants.

The termination under Sub-Para (b) of this Sub-Clause shall proceed in the manner prescribed under Sub-Clauses 63.1 to 63.4 and the payment under Sub-Clause 63.3 shall be made after having deducted the amounts due to the Employer under Sub-Para (a) and (c) of this Sub-Clause.

#### **75.1 Termination of Contract for Employer's Convenience**

The Employer shall be entitled to terminate the Contract at any time for the Employer's convenience after giving 30 days prior notice to the Contractor, with a copy to the Engineer. In the event of such termination, the Contractor:

- (a) shall proceed as provided in Sub-Clause 65.7 hereof; and
- (b) shall be paid by the Employer as provided in Sub-Clause 65.8 hereof.

#### **76.1 Liability of Contractor**

The Contractor or his Subcontractors or assigns shall follow strictly, all relevant labour laws including the Workmen's Compensation Act and the Employer shall be fully indemnified for all claims, damages etc. arising out of any dispute between the Contractor, his Subcontractors or assigns and the labour employed by them.

#### **77.1 Joint and Several Liability**

If the Contractor is a joint venture of two or more persons, all such persons shall be jointly and severally bound to the Employer for the fulfillment of the terms of the Contract and shall designate one of such persons to act as leader with authority to bind the joint venture. The composition or the constitution of the joint venture shall not be altered without the prior consent of the Employer.

#### **78.1 Details to be Confidential**

The Contractor shall treat the details of the Contract as private and confidential, save in so far as may be necessary for the purposes thereof, and shall not publish or disclose the same or any particulars thereof in any trade or technical paper or elsewhere without the prior consent in writing of the



PIPING WORKS AT PIRKOH & LOTI FIELDS

Employer or the Engineer. If any dispute arises as to the necessity of any publication or disclosure for the purpose of the Contract, the same shall be referred to the decision of the Engineer whose award shall be final.

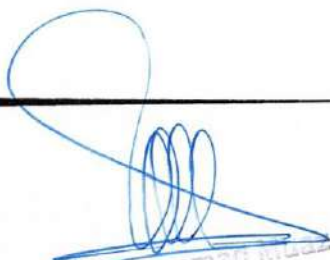

Muhammad Ali  
C.E. (P/Line)  
Ext. 5065



**OIL & GAS DEVELOPMENT COMPANY LTD**

**BOQ**

**FOR**

**FABRICATION, WELDING & INSTALLATION  
OF AG UNIT FROM  
PIRKOH TO LOTI GAS FIELD**

**TENDER ENQUIRY NO: \_\_\_\_\_**

---

*Melkeed*  
*AS*  
Muhammad Ashraf  
Sr. Tech. Officer (Elect)  
Process & Plants Deptt OGDCL  
Ext. .... 2407



## TABLE OF CONTENTS

Section No.	Description	Sheet No.
1	Summary of Bid Price Schedule	3
2	Piping Works	4
3	Note's	5

*Wells*  
*Ashra*  
Muhammad Ashrafi  
Sr. Technicial (Elect)  
Process & Plants Deptt OGDC  
Ext.....



Location:- PIRKOH &amp; LOTI FIELDS

Completion Period: - 60 days

**SUMMARY OF BID PRICE SCHEDULE**

S No.	Description	TOTAL COST (WITHOUT PST / ICT) (Rs.)
01	Welding at Loti	_____
02	Dismantling & Cutting at Pirkoh	_____
03	Re-Welding of dismantled spool at Loti	_____
04	Installation of Valves, Fittings at Loti	_____
05	Discarding of Insulation / Cladding	_____
06	Installation of Insulation / Cladding	_____
07	Hydrostatic Testing of Piping	_____

<b>Total (Rs.)*</b>	
---------------------	--

**IN WORDS: PKR****\* NOTE:**

- 1- The Quoted cost is inclusive of all Tax's, duties, levies except provincial sales tax (PST) / ICT where applicable, which shall be paid / borne by OGDCL as actual.
- 2- Price enter should be by hand, no typing or computer printing allowed
- 3- Amendment, Modification, re-production of this BOQ is not allow, failure to comply will lead to dis-qualification.

**Sign & Stamp**  
(Employer)**Sign & Stamp**  
(By Bidder)

*Weller*  
*M. Ashraf*  
**Muhammad Ashraf**  
Sr. Tech Officer (Elect)  
Process & Plants Deptt OGDCL  
Ext.....*2107*

OIL & GAS DEVELOPMENT COMPANY LIMITED						
Welding, Fabrication & Installation of AG Unit from Pirkoh to Loti Gas Field, Balochistan						
BOQ						
SR#	ITEM DESCRIPTION	UNIT	QTY.	UNIT RATE	TOTAL	REMARKS
				Without PST (PKR)	Rate (without PST) x Qty (PKR)	
<b>1.0 WELDING/THREADING AT LOTI GAS FIELD</b>						
	Fabrication & Welding/threading including cutting, bevelling & grinding of Sch-40 pipe of different size dia such as: 16", 6", 4", 3", 2", 1"	Dia Inch	2632			
<i>The above rates includes but not limited to the followings:</i>						
a Receiving & Loading from Store, transportation, unloading at designated location of different dia pipes and allied materials.						
b All Equipments, Machinery, Tools, Consumable, POL, Cutting Gases, etc required for completion.						
c Tie-in connection						
d Area must be cleared and re-instated after completion of work						
<b>2.0 DISMANTELLING &amp; CUTTING AT PIRKOH GAS FIELDS</b>						
i	Dismantelling of 16" Dia pipe (Sch-40)	Dia Inch	320			
ii	Dismantelling & Cutting of different sizes of different size dia such as: 16", 6", 2", 1" at Pirkoh Gas Field	Dia Inch	742			
iii	Dismantelling of Different sizes of Valves / Fittings	Nos	79			
iv	Dismantelling / Installation of K.O Drum at Pirkoh/Loti Gas Field	No.	1			
v	Dismantelling / Installation of Air Reciever K.O Drum at Pirkoh / Loti Gas Field	No.	1			
<i>The above rates of items includes but not limited to the followings:</i>						
a Cutting, Receiving, Loading, transportation, unloading of dia pipes and allied material at designated location.						
b All the dismantelling / cutting spool marking as per drawings						
c All Equipments, Machinery, Tools, Consumable, POL, Cutting Gases etc required for completion.						
d Area must be cleared and re-instated after completion of work						
<i>Subtotal of 2.0 (i+ii+iii+iv+v)</i>				-	-	
<b>3.0 Re-welding of Dismantling Spool at Loti Gas Field</b>						
i	Fabrication, Beveling & Re-welding of 16" Dia pipe (Sch-40)	Dia Inch	320			
ii	Fabrication, Beveling & Re-welding of different size dia pipe such as: 16", 6", 4", 3", 2", 1"	Dia Inch	742			
<i>The above rates of items includes but not limited to the followings:</i>						
a Cutting, Receiving, Loading, transportation, unloading of dia pipes and allied material at designated location.						
b All the dismantelling / cutting spool marking as per drawings						
c All Equipments, Machinery, Tools, Consumable, POL, Cutting Gases etc required for completion.						
d Area must be cleared and re-instated after completion of work						
<i>Subtotal of 3.0 (i+ii)</i>				-	-	
<b>4.0 INSTALLATION OF VALVES AT LOTI GAS FIELD</b>						
	Installation of different dia valves such as: 16", 8", 6", 4", 3", 2", 1"	Nos	79			
<i>The above rates includes but not limited to the followings:</i>						
a Supply of all type of valves & associated materials will be OGDCL responsibility						
b Receiving, Loading, transportation, unloading of above mentioned dia valves, bends and allied material at desired location.						
c Air blowing/cleaning of valves, stainers before installation.						
d Cleaning of level glass after installation is in contractors scope of work.						
e Installation of valves, stainers between flanges and bolting up with gasket.						
<b>5.0 DISCARDING OF INSULATION / CLADDING AT PIPES AT PIRKOH FIELD</b>						
	Discarding of Insulation / Cladding at different dia pipes	Sq.M	100			
<b>6.0 INSTALLATION OF INSULATION / CLADDING AT PIPES AT LOTI FIELD</b>						
	Insulation / Cladding at different dia pipes	Sq.M	100			
<i>The above rates includes but not limited to the followings:</i>						
i Receiving, Loading, transportation, unloading of cladding material at desired location.						
ii Proper installation as per Oil Industry practice						

  
**Muhammad Asif**  
 Sr. Tech Officer (Elect)  
 Process & Plans Dept OGDCL  
 Ext... 4107



OIL & GAS DEVELOPMENT COMPANY LIMITED						
Welding, Fabrication & Installaion of AG Unit from Pirkoh to Loti Gas Field, Balochistan						
BOQ						
SR#	ITEM DESCRIPTION	UNIT	QTY.	UNIT RATE	TOTAL	REMARKS
				Without PST	Rate (without PST) x Qty	
7.0	HYDROSTATIC TESTING OF PIPING					
	Hydrostatic testing of piping as per project specification and Client requirements. Contractor shall provide all material, tools, equipment, supply of water, tempory test plugs, couplings, flanges, nuts, bolts, recorder guage, cleaning and flushing and all necessary arrangements required for hydrostatic testing would be responsibility of contractor and should be done as per relevant specification, Code & standard. (Note: this is optional activity , contarctor is bound to do if OGDCL desire)	M	850			
				<b>GRAND TOTAL</b>		
<b>NOTES:</b>						
1	The Quantities taken in this BOQ are estimated only for bidding purpose. Contractor is responsible to estimate the quantities as per site requirements, drawings & tender documents.					
2	Contractor is responsible to add any missing / required item as per scope of works, drawings, specifications & tender documents.					
3	OGDCL reserves the right to increase / decrease the quantum of work. However payment will be made on actual work done as per verifiable Running and Final Bills					
4	The Quoted cost is inclusive of all Tax's, duties, levies except provincial sales tax (PST) / ICT where applicable, which shall be paid / borne by OGDCL as actual.					
5	Contractor to comply with Relevant codes & standards. However, Specifications and Dawings are attached in VOL-II & Vol-III respectively.					
6	All area must be cleared and reinstated after completion of work.					
7	Mobilization / De-Mobilization, Equipment, Machinery, Tools, Manpower, Camping, utilities, etc required for completion of work.					
8	Establishment of camp at nearest suitable location for execution of work at site					
9	Approval of client should be taken by the contractor before undertaking any kind of construction and installation work at site.					
10	Radiography and third party inspection shall be done by OGDCL.					
11	Contractor should produce daily progress & monthly report as per format acceptable by Engineer Incharge.					
12	Contractor require approval from Engineer Incharge to commence any type of work.					

  
  
**Muhammad Ashraf**  
 Sr. Tech Officer (Elect)  
 Process & Plants Deptt OGDCL  
 Ext ..... 2457

**Note # 1: General:**

- 1) All consumables to be supplied by the CONTRACTOR (Includes welding rods, cutting/grinding disc, gloves, cutting gases, grinders, beveling machine, etc.) required for the execution of work as per specification and satisfaction of the OGDCL representative at site and approval of company Engineer Incharge.
- 2) Tie-in at plant shall also be responsibility of the contractor.
- 3) Radiography shall be done as per code.
- 4) CONTRACTOR to verify all dimensions, ground elevations and profile before undertaking any fabrication works.
- 5) All testing equipment, arrangements & consumables shall be the CONTRACTOR'S responsibility.
- 6) All areas to be cleaned and re-instated after completion of WORKS.
- 7) All material for the hydro testing including water, test plugs and consumables shall be supplied by CONTRACTOR.
- 8) The contractor shall be paid on actual work done.
- 9) CONTRACTOR is responsible for pre-commissioning and commissioning of the system.
- 10) Construction Contractor to comply with Specification for piping Construction & Installation, standard and codes.
- 11) Contractor to cooperate with Government inspector, OGDCL Staff, consultant, 3<sup>rd</sup> party inspector or other contractor appointed by OGDCL to perform their assigned duties.
- 12) Liaison and payment of charges associate with Government regulating companies required during construction and commissioning of the pipeline to be borne by the contractor.
- 13) Transportation of material from store and all other bidder's supplied items shall be in bidder's scope

**Note # 2: The rates include:**

- 1) Mobilization/ Demobilization of Machinery / Equipment, staff & other expenditure required for the purpose.
- 2) Overwriting / cutting are to be avoided and to be initialed if inevitable.
- 3) OGDCL reserves the right to increase/ decrease the quantum of work. The quantities mentioned above are estimated and may also increase or decrease during execution of the work.
- 4) Payment will be made on actual work done as per verifiable Running and Final Bills
- 5) The lowest rates quoted shall be approved and payments will be made as per actual quantum of work verified by the site Engineer.

*Walter*  
Muhammad Ashraf  
Sr. Tech Officer (Elect)  
Process & Plants Dept. OGDCL  
Ext. ....  
*2/27*

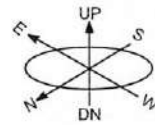
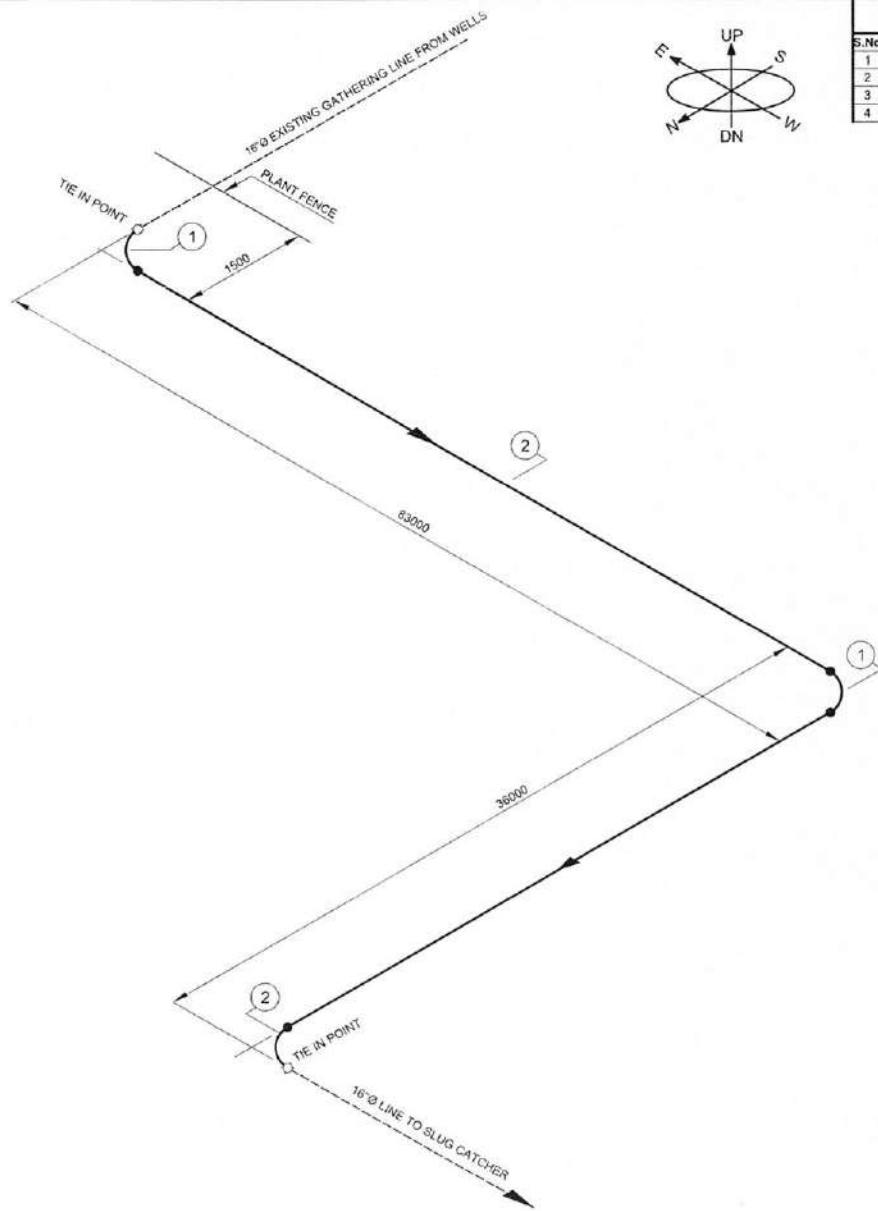

### MATERIAL LIST

S.No	SIZE	ITEMS	RATING	STANDARD	QTY.	MATERIAL
1	16"	ELBOW 90° BW	Sch.40	ANSI 16.9	3	A-234 GR. SWP B
2	16"	PIPE BE	Sch. 40	ANSI 16.9	119M	A-106-Gr.B
3						
4						

NEW LINE \_\_\_\_\_  
 EXIT LINE - - - - -

**NOTE:-**

- 1. PROVISIONAL DRAWING ONLY FOR BCO.

Rev. 0	Issue For Approval			
Rev. No	Revision No.	Cad By	Checked By	Approved By
 <b>OIL &amp; GAS DEVELOPMENT COMPANY LTD.</b> PROCESS & PLANTS DEPARTMENT Loti Gas Field				
TITLE:- <b>16"Ø GAS GATHERING LINE FROM WELLS TO SLUG CATCHER</b>				
CAD BY <b>JAWAD QASBI</b> Sr. Tech. Officer (Drafting)	CHECKED BY Mian Muhd. Shafique C.T.O (Mech.)	APPROVED BY Sohail Anwer Manager (P&P)/C-B	DRAWING NO. PP-LOTHSC-018	
Scale: NTS	Computer Code PN.01	Rev. 0	Date 12-10-2018	

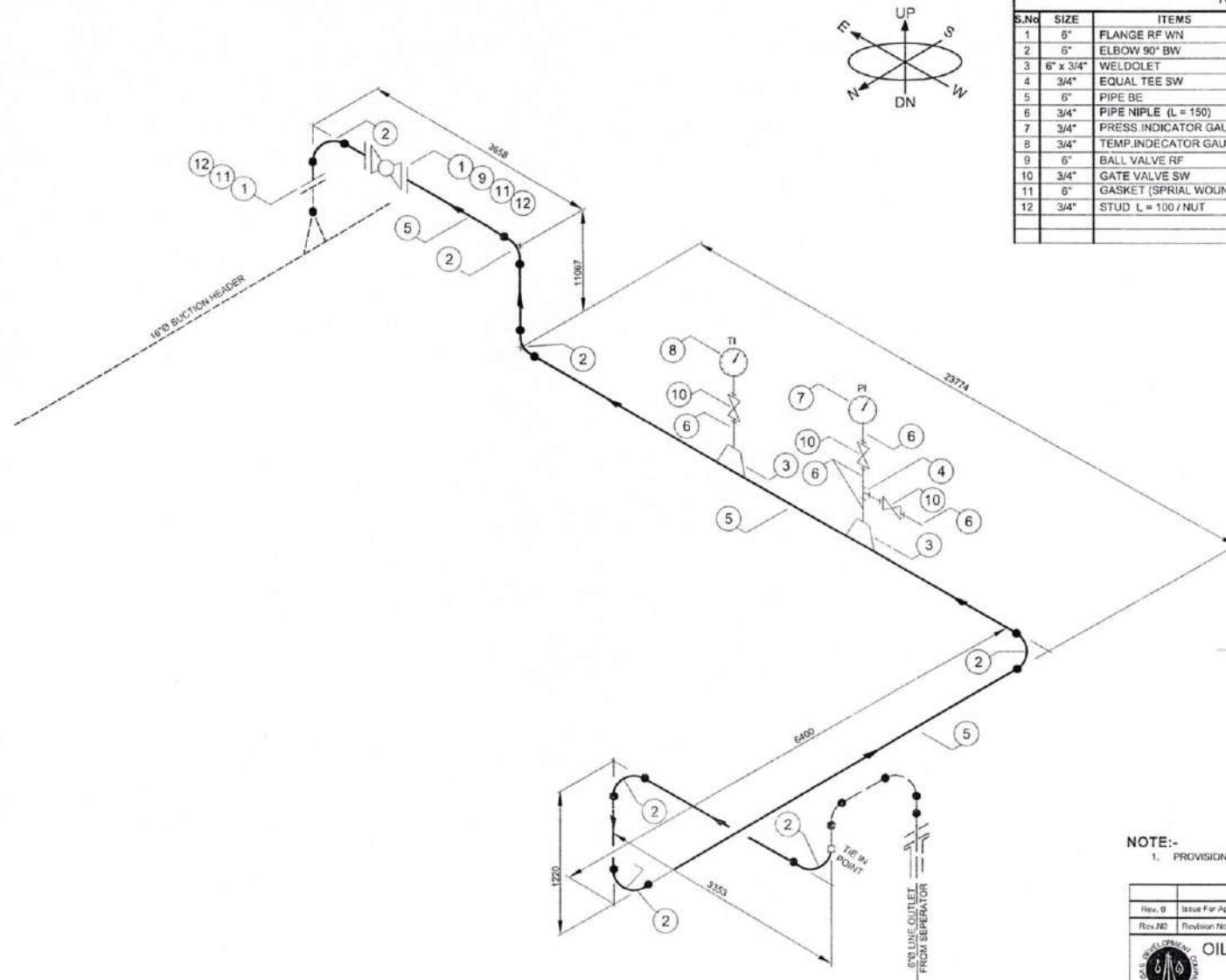

### MATERIAL LIST

S.No	SIZE	ITEMS	RATING	STANDARD	QTY.	MATERIAL
1	6"	FLANGE RF WN	150#	ANSI 16.5	3	A-105
2	6"	ELBOW 90° BW	Sch. 40	ANSI 16.9	7	A-234 GR. BWP B
3	6" x 3/4"	WELDOLET	3000#	ANSI 16.9	2	A-105
4	3/4"	EQUAL TEE SW	3000#	ANSI 16.9	1	A-105
5	6"	PIPE BE	Sch. 40	ANSI 36.10	40 M	A-106-Gr.B
6	3/4"	PIPE NIPL (L = 150)	Sch. 80	ANSI 36.10	7	A-106-Gr.B
7	3/4"	PRESS.INDICATOR GAUGE(500 psi)			1	
8	3/4"	TEMP.INDICATOR GAUGE(400 °F)			1	
9	6"	BALL VALVE RF	150#		1	
10	3/4"	GATE VALVE SW	800#		3	
11	6"	GASKET (SPRIAL WOUND)	150#	ANSI 36.20	3	S/S-304
12	3/4"	STUD L = 100 / NUT			16 / 32	A-193-GR.B7 / A-194-GR.2H

NEW LINE \_\_\_\_\_  
 EXIT LINE - - - - -

NOTE:-  
 1. PROVISIONAL DRAWING ONLY FOR BOG.

Rev. 0	Issue For Approval			
Rev. No	Revision Note	Cad By	Checked By	Approved By
 <b>OIL &amp; GAS DEVELOPMENT COMPANY LTD.</b> PROCESS & PLANTS DEPARTMENT Loti Gas Field				
TITLE:- <b>6"Ø GAS LINE FROM SEPERATOR TO 16"Ø SUCTION HEADER</b>				
CAD BY <b>JAWAD ULAYD</b> Sr. Tech. Officer(Draughting)		CHECKED BY Mian Mund. Shafique C.T.O (Mech.)		APPROVED BY Sohail Anwer Manager (P&P)C-B
Scale: NTS		Computer Code PN 01		DRAWING NO. PP-LOTH-ISO-001  Date 01-10-2018

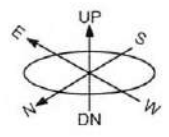

**MATERIAL LIST**

S.No	SIZE	ITEMS	RATING	STANDARD	QTY.	MATERIAL
1	6"	FLANGE RF WN	600#	ANSI 16.5	3	A-105
2	6"	ELBOW 90° BW	Sch.80	ANSI 16.9	4	A-234 GR, BWP B
3	6"	PIPE BE	Sch. 80	ANSI 36.10	40 M	A-106-Gr.B
4	6"	BALL VALVE RF	600#		1	
5	6"	GASKET R-45	600#	ANSI 36.21	3	S/S-304
6	1"	STUD L = 170 / NUT			36 / 72	A-193-GR.B7 / A-194-GR.2H

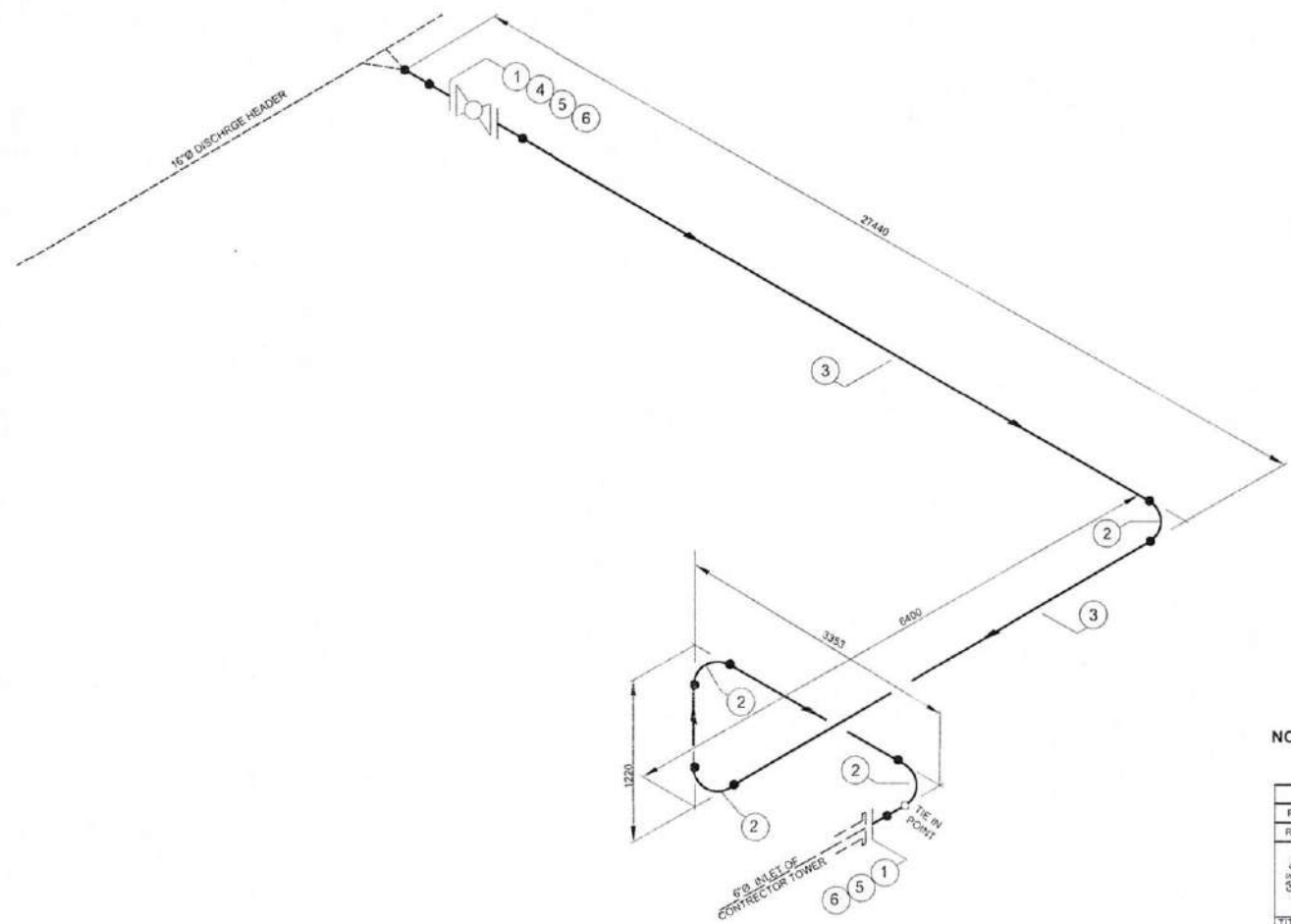

NEW LINE \_\_\_\_\_  
 EXIT LINE - - - - -

**NOTE:-**  
 1. PROVISIONAL DRAWING ONLY FOR BOQ.

Rev. 0	Issue For Approval			
Rev.No	Revision Note	Caed By	Checked By	Approved By
 <b>OIL &amp; GAS DEVELOPMENT COMPANY LTD.</b> <b>PROCESS &amp; PLANTS DEPARTMENT</b> <b>Loti Gas Field</b>				
<b>TITLE:- 6"Ø GAS LINE FROM DISCHARGE HEADER TO CONECTOR TOWER</b>				
CAD BY <b>SARWAR USAD</b> Sr.Tech Officer(Draughting)	CHECKED BY Mian Muhd. Shafique C.T.O (Mech.)	APPROVED BY Sohail Anwar Manager (P&P)JC-B	DRAWING NO. PP-LOTI-HSC-002	
Scale: NTS	Computer Code PN.01	Rev. 0	Date 01-10-2018	

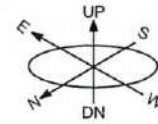

### MATERIAL LIST

S.No	SIZE	ITEMS	RATING	STANDARD	QTY.	MATERIAL
1	6"	FLANGE RF WN	150#	ANSI 16.5	3	A-105
2	6"	ELBOW 90° BW	Sch. 40	ANSI 16.9	4	A-234 GR, BWP B
3	6" x 3/4"	SOCKOLET	3000#	ANSI 16.9	2	A-105
4	3/4"	EQUAL TEE SW	3000#	ANSI 16.9	1	A-105
5	6"	PIPE BE	Sch. 40	ANSI 36.10	30 M	A-106-Gr.B
6	3/4"	PIPE NIPPLE (L = 150)	Sch. 80	ANSI 36.10	7	A-106-Gr.B
7	3/4"	PRESS.INDICATOR GAUGE(500 psi)			1	
8	3/4"	TEMP.INDICATOR GAUGE(400 °F)			1	
9	6"	BALL VALVE RF	150#		1	
10	3/4"	GATE VALVE SW	800#		3	
11	6"	GASKET (SPIRAL WOUND)	150#	ANSI 36.21	3	S/S-304
12	3/4"	STUD L = 100 / NUT			16 / 32	A-193-GR.B7 / A-194-GR.2H

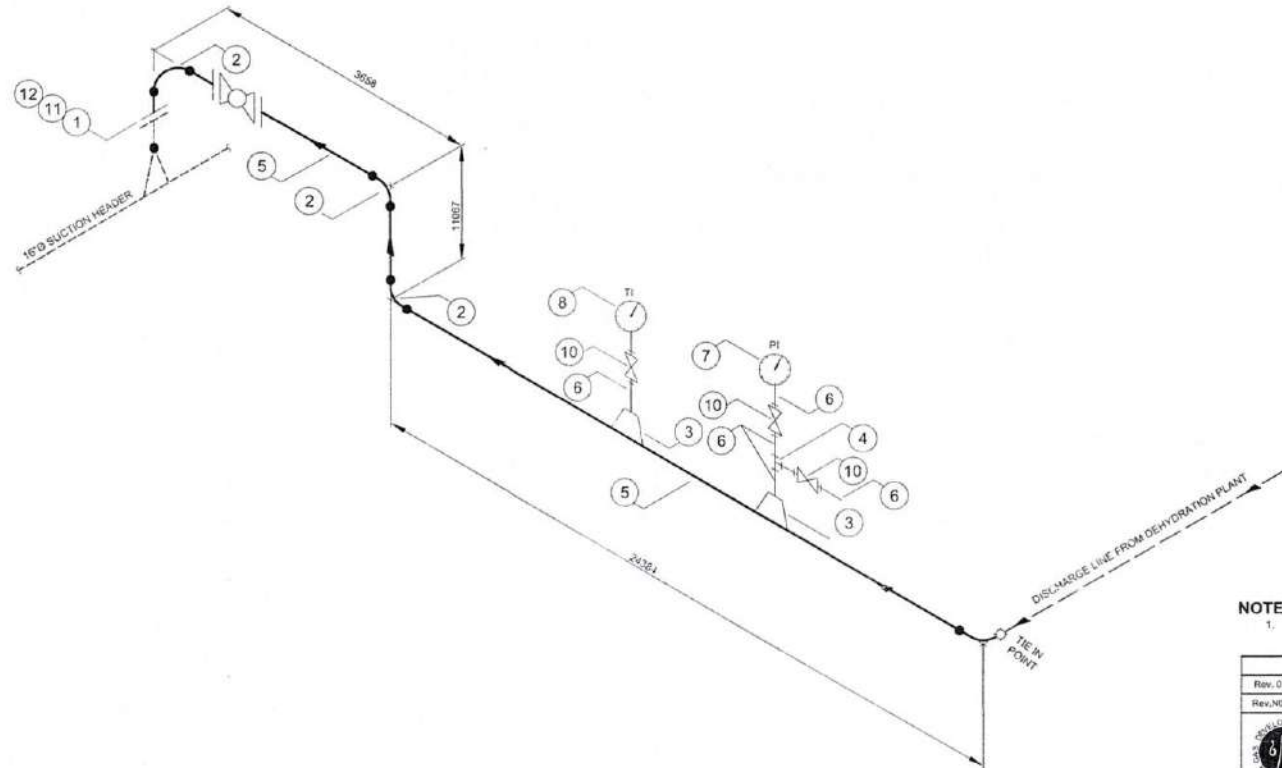

NEW LINE \_\_\_\_\_  
 EXIT LINE - - - - -

**NOTE:-**

1. PROVISIONAL DRAWING ONLY FOR BOQ.

Rev. 0	Issue For Approval			
Rev. No	Revision Note	Cad By	Checked By	Approved By
 <b>OIL &amp; GAS DEVELOPMENT COMPANY LTD.</b> <b>PROCESS &amp; PLANTS DEPARTMENT</b> <b>Loti Gas Field</b>				
<b>TITLE:-</b> <b>6"Ø GAS LINE FROM DEHYDRATION UNIT</b> <b>OUTLET LINE Ø6" TO 16"Ø SUCTION HEADER</b>				
CAD BY <b>JAWAD QASAB</b> Sr.Tech.Officer(Draughting)	CHECKED BY Man Muhs. Shafigue C.T.O (Mech.)	APPROVED BY Sohail Anwer Manager (P&P)C-B	DRAWING NO. PP-LOTI-ISO-003	
Scale: NTS	Computer Code PN 01	Rev. 0	Date 02-10-2018	

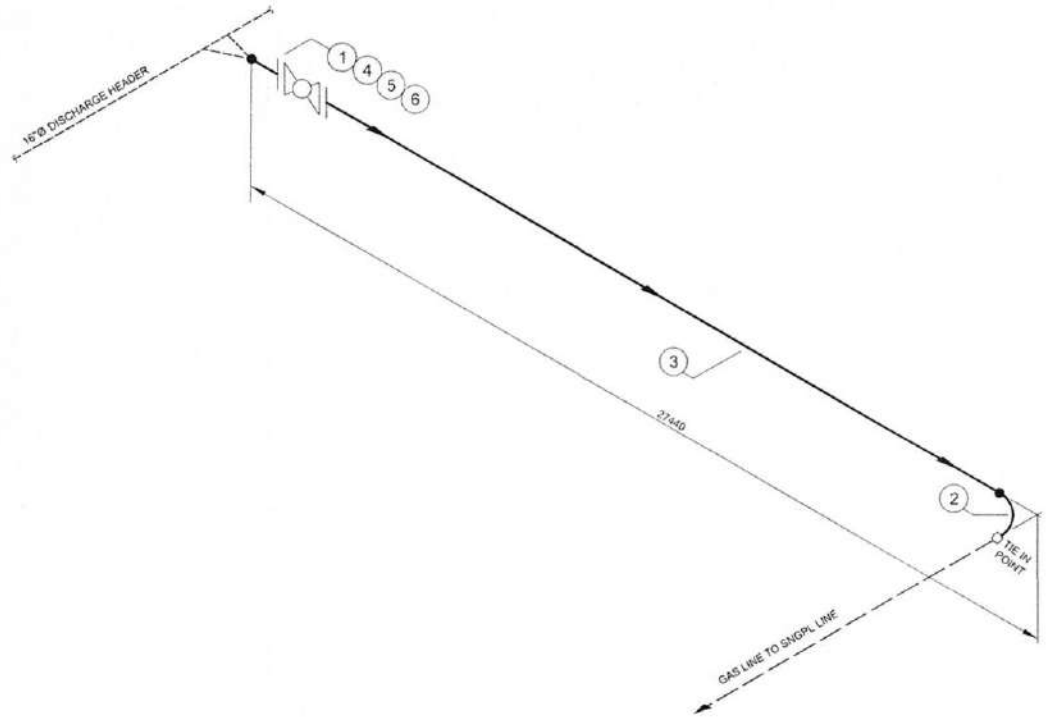
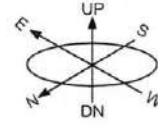

**MATERIAL LIST**

S.No	SIZE	ITEMS	RATING	STANDARD	QTY.	MATERIAL
1	6"	FLANGE RF WN	600#	ANSI 16.5	2	A-105
2	6"	ELBOW 90° BW	Sch.80	ANSI 16.9	1	A-234 GR. BWP B
3	6"	PIPE BE	Sch. 80	ANSI 36.10	29 M	A-106-Gr.B
4	6"	BALL VALVE RTJ	600#		1	
5	6"	GASKET R-46	600#	ANSI 36.21	2	S/S-304
6	1"	STUD L = 170 / NUT			24 / 48	A-193-GR.B7 / A-194-GR.2H

NEW LINE \_\_\_\_\_  
 EXIT LINE \_\_\_\_\_

**NOTE:-**  
 1. PROVISIONAL DRAWING ONLY FOR BOQ.

Rev. 0	Issue For Approval			
Rev.NO	Revision Note	Cad By	Checked By	Approved By
 <b>OIL &amp; GAS DEVELOPMENT COMPANY LTD.</b> PROCESS & PLANTS DEPARTMENT Loti Gas Field				
<b>TITLE:-</b> 6"Ø GAS LINE FROM DEHYDRATION UNIT OUTLET LINE Ø6" TO 16"Ø SUCTION HEADER				
CAD BY <b>JAWAD BRASS</b> Sr.Tech.Officer(Drawing)	CHECKED BY Mian Muht. Shafique C.T.O (Mech.)	APPROVED BY Sehail Anwer Manager (P&P)C-B	DRAWING NO. PP-LOTI-ISO-004	
Scale: NTS	Computer Code PN_01	Rev. 0	Date 02-10-2018	

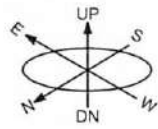

### MATERIAL LIST

S.No	SIZE	ITEMS	RATING	STANDARD	QTY.	MATERIAL
1	16"	FLANGE RF WN	150#	ANSI 16.5	3	A-105
2	6"	FLANGE RF WN	150#	ANSI 16.5	2	A-105
3	2"	FLANGE RF WN	150#	ANSI 16.5	1	
4	16"	END BLIND RF	150#	ANSI 16.9	2	A-105
5	16"	END CAP BW	Sch.40	ANSI 16.9	1	A-105
6	16" x 2"	SOCKOLET	3000#	ANSI 16.9	1	A-105
7	16" x 3/4"	SOCKOLET	3000#	ANSI 16.9	3	A-105
8	16"	EQUAL TEE BW	Sch.40	ANSI 16.9	2	A-105
9	6"x16"x6"	REDUCING TEE BW	Sch.40	ANSI 16.9	2	A-105
10	3/4"	EQUAL TEE SW	3000#	ANSI 16.9	1	A-105
11	16"	PIPE BE	Sch. 40	ANSI 36.10	41 M	A-106-Gr.B
12	3/4"	PIPE NIPLE (L = 150)	Sch. 80	ANSI 36.10	9	A-106-Gr.B
13	3/4"	PRESS.INDICATOR GAUGE(10000 psi)			1	
14	3/4"	TEMP.INDICATOR GAUGE(400 °F)			1	
15	3/4"	GATE VALVE SW	800#		4	
16	16"	GASKET (SPRIAL WOUND)	150#	ANSI 36.21	3	S/S-304
17	6"	GASKET (SPRIAL WOUND)	150#	ANSI 36.21	2	S/S-304
18	2"	GASKET (SPRIAL WOUND)	150#	ANSI 36.21	1	S/S-304
19	1"	STUD L = 140 / NUT			36 / 72	A-193-GR.B7 / A-194-GR.2H
20	3/4"	STUD L = 100 / NUT			16 / 32	A-193-GR.B7 / A-194-GR.2H
21	5/8"	STUD L = 70 / NUT			4 / 16	A-193-GR.B7 / A-194-GR.2H

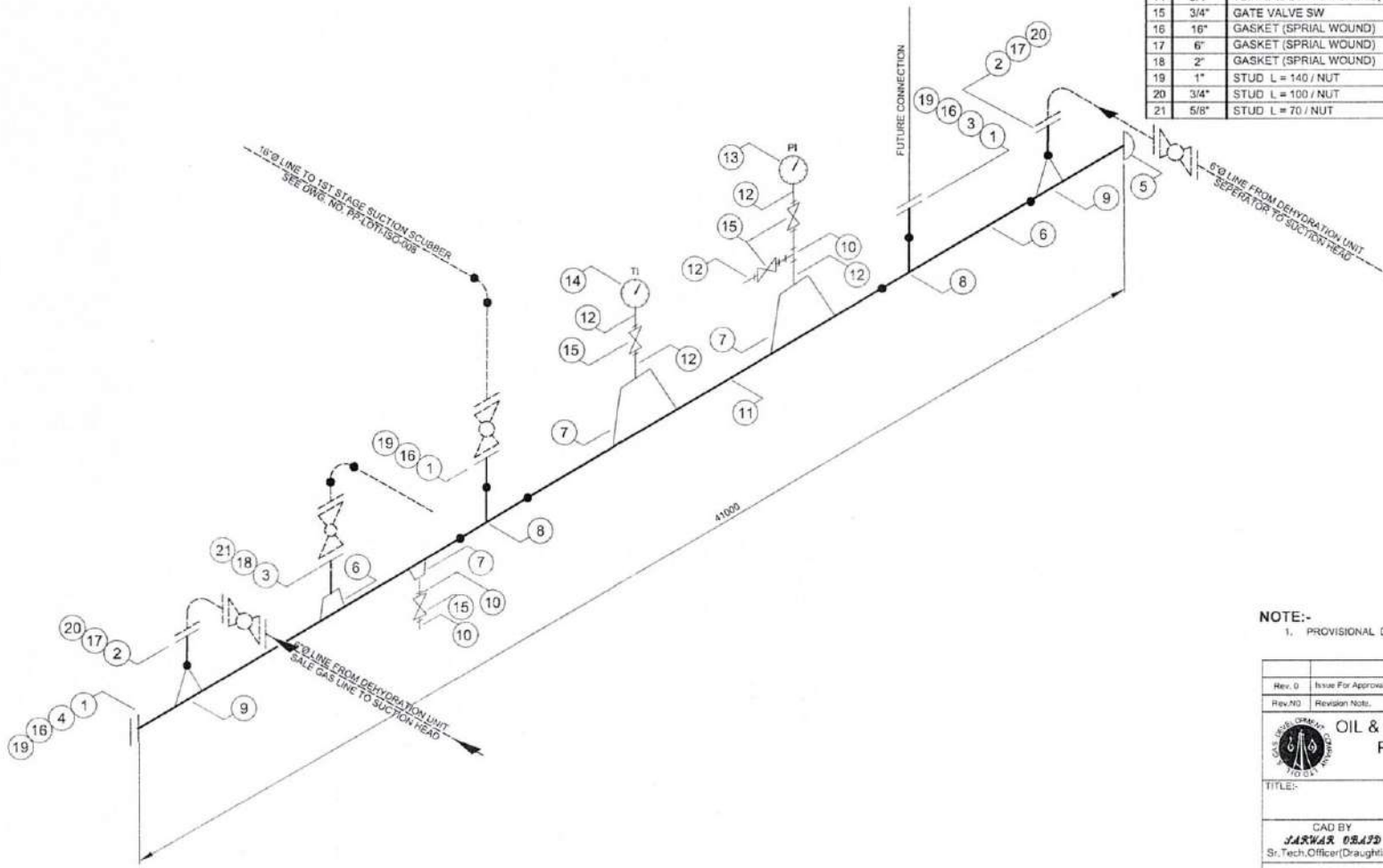

NEW LINE \_\_\_\_\_  
 EXIST LINE - - - - -

NOTE:-  
 1. PROVISIONAL DRAWING ONLY FOR BOQ.

Rev. 0	Issue For Approval			
Rev. No.	Revision Note	Cad By	Checked By	Approved By
 <b>OIL &amp; GAS DEVELOPMENT COMPANY LTD.</b> PROCESS & PLANTS DEPARTMENT Loti Gas Field				
TITLE: <b>16"Ø SUCTION HEADER</b>				
CAD BY <b>JAWAID BASHIR</b> Sr. Tech. Officer (Drafting)	CHECKED BY Mian Mujib Shafique C.T.O (Mech.)	APPROVED BY Sohail Anwar Manager (P&P) C-B	DRAWING NO. PP-LOTI-ISO-005	
Scale: NTS	Computer Code PN_01	Rev. 0	Date 03-10-2018	



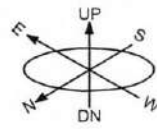

### MATERIAL LIST

S.No	SIZE	ITEMS	RATING	STANDARD	QTY.	MATERIAL
1	16"	FLANGE RTJ WN	600#	ANSI 16.5	1	A-105
2	6"	FLANGE RTJ WN	600#	ANSI 16.5	4	A-105
3	16"	END BLIND RF	600#	ANSI 16.0	1	A-105
4	16"	END CAP BW	Sch.80	ANSI 16.9	1	A-105
5	16" x 3/4"	SOCKOLET	6000#	ANSI 16.9	3	A-105
6	16"x16"x6"	REDUCING TEE BW	Sch.80	ANSI 16.9	4	A-105
7	3/4"	EQUAL TEE SW	6000#	ANSI 16.9	1	A-105
8	16"	PIPE BE	Sch. 80	ANSI 36.10	41 M	A-106-Gr.B
9	3/4"	PIPE NIPL (L = 150)	Sch. 160	ANSI 36.10	9	A-106-Gr.B
10	3/4"	PRESS.INDICATOR GAUGE(1000 psi)			1	
11	3/4"	TEMP.INDECATOR GAUGE(400 °F)			1	
12	3/4"	GATE VALVE SW	1500#		4	
13	16"	GASKET R-65	600#	ANSI 36.21	1	S/S-304
14	6"	GASKET R-45	600#	ANSI 36.21	4	S/S-304
15	1 1/2"	STUD L = 255 / NUT			20 / 40	A-193-GR.B7 / A-194-GR.2H
16	1"	STUD L = 170 / NUT			48 / 96	A-193-GR.B7 / A-194-GR.2H

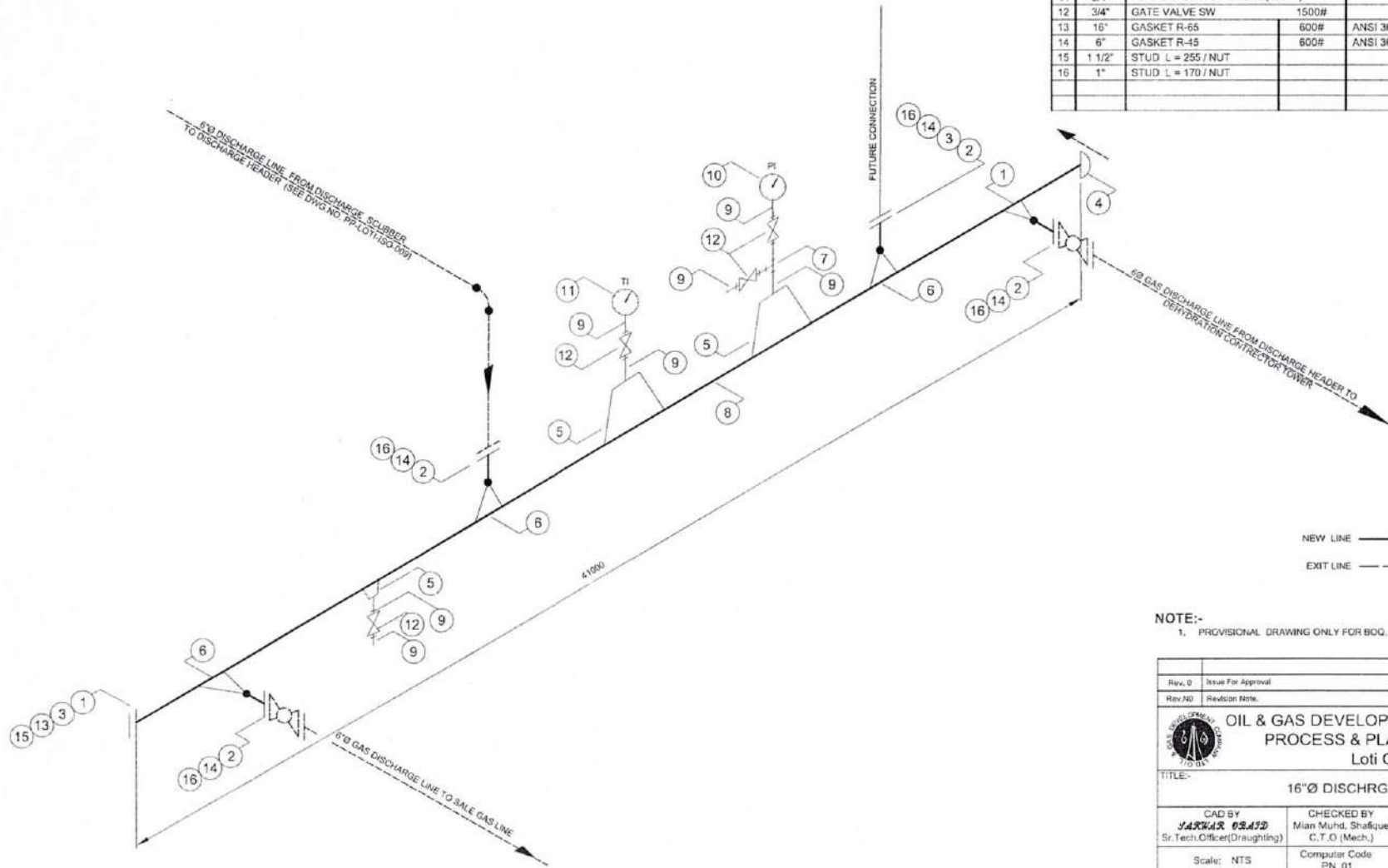

NEW LINE \_\_\_\_\_  
EXIT LINE - - - - -

NOTE:-  
1. PROVISIONAL DRAWING ONLY FOR BOQ.

Rev. 0	Issue For Approval			
Rev. No	Revision Note.	Cad By	Checked By	Approved By
 <b>OIL &amp; GAS DEVELOPMENT COMPANY LTD.</b> PROCESS & PLANTS DEPARTMENT Loti Gas Field				
TITLE:- <b>16"Ø DISCHARGE HEADER</b>				
CAD BY <b>JARWAR GRAYD</b> Sr. Tech. Officer (Drafting)		CHECKED BY Mian Muid. Shafique C.T.O. (Mech.)		APPROVED BY Suhail Anwar Manager (P&P)C-B
Scale: NTS		Computer Code PN_01		DRAWING NO. PP-LOTI-ISO-006 Date 03-10-2018

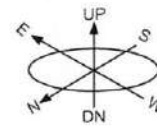

### MATERIAL LIST

S.No	SIZE	ITEMS	RATING	STANDARD	QTY.	MATERIAL
1	4"	FLANGE RF WN	150#	ANSI 16.5	2	A-105
2	2"	FLANGE RF WN	150#	ANSI 16.5	2	A-105
3	2"	ELBOW 90° BW	Sch.40	ANSI 16.9	2	A-234 GR. BWP B
4	6"	END CAP BW	Sch.40	ANSI 16.9	2	A-105
5	16" x 2"	WELDOLET	3000#	ANSI 16.9	1	A-105
6	6" x 4"	CONCENTRIC REDUCING BW	Sch.40	ANSI 16.9	1	A-105
7	6"	EQUAL TEE BW	Sch.40	ANSI 16.9	2	A-105
8	6"x6"x2"	REDUCING TEE BW	Sch.40	ANSI 16.9	1	A-105
9	4"	BALL VALVE RF	150#		1	
10	2"	BALL VALVE RF	150#		1	
11	6"	PIPE BE	Sch. 40	ANSI 16.9	41M	A-105-Gr.B
12	4"	PIPE BE	Sch. 40	ANSI 36.10	12 M	A-105-Gr.B
13	2"	PIPE	Sch. 40	ANSI 36.10	7M	A-105-Gr.B
14	4"	GASKET (SPRIAL WOUND)	150#	ANSI 36.21	2	S/S-304
15	2"	GASKET (SPRIAL WOUND)	150#	ANSI 36.21	2	S/S-304
16	5/8"	STUD L = 95 / NUT			16 / 32	A-193-GR.B7 / A-194-GR.2H
17	1/2"	STUD L = 85 / NUT			8 / 16	A-193-GR.B7 / A-194-GR.2H

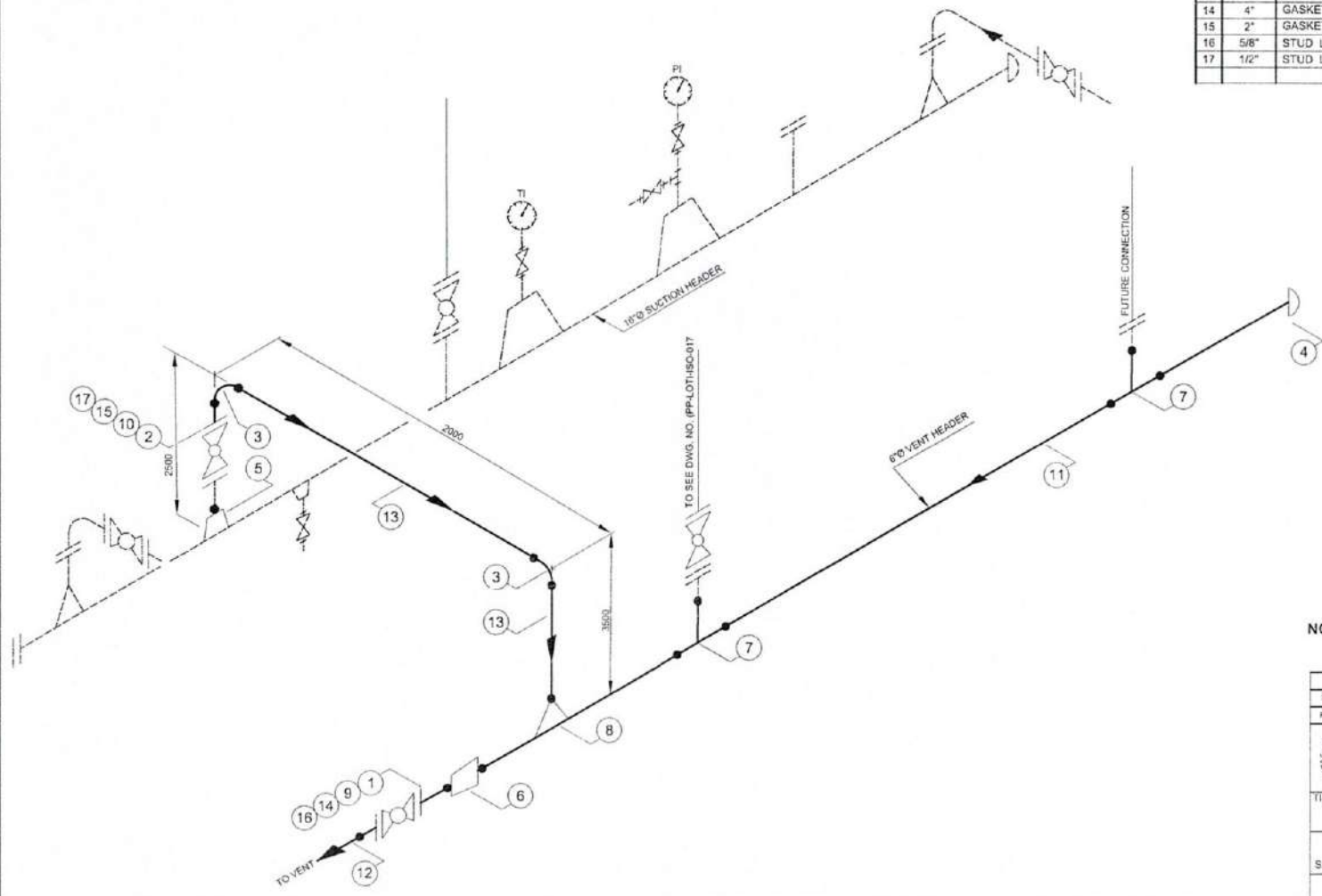

NEW LINE \_\_\_\_\_  
EXIT LINE - - - - -

NOTE:-  
1. PROVISIONAL DRAWING ONLY FOR BOQ.

Rev. 0	Issue For Approval			
Rev.NO	Revision Note.	Cad By	Checked By	Approved By
 <b>OIL &amp; GAS DEVELOPMENT COMPANY LTD.</b> PROCESS & PLANTS DEPARTMENT Loti Gas Field				
TITLE:- <b>2"Ø GAS LINE TO VENT HEADER</b>				
CAD BY <b>SAYMA CRASH</b> Sr.Tech.Officer(Draughting)	CHECKED BY Mian Muht. Shaique C.T.O (Mech.)	APPROVED BY Sonal Anwer Manager (P&P-C-B)	DRAWING NO. PP-LOTI-ISC-007	
Scale: NTS	Computer Code PN_01	Rev. 0	Date 04-10-2018	

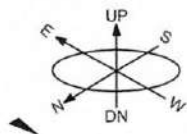

### MATERIAL LIST

S.No	SIZE	ITEMS	RATING	STANDARD	QTY.	MATERIAL
1	6"	FLANGE RF WN	150#	ANSI 16.5	3	A-105
2	6"	END BLIND RF	150#	ANSI 16.5	1	A-105
3	6"	ELBOW 90° BW	Sch.40	ANSI 16.9	2	A-234 GR. BWP B
4	6"	PIPE BE	Sch. 40	ANSI 16.9	12M	A-106-Gr.B
5	6"	BALLVALVE RF	150#			
6	6"	GASKET (SPIRAL WOUND)	150#	ANSI 36.21	3	S/S-304
7	3/4"	STUD L = 100 / NUT			24 / 48	A-193-GR.B7 / A-194-GR.2H

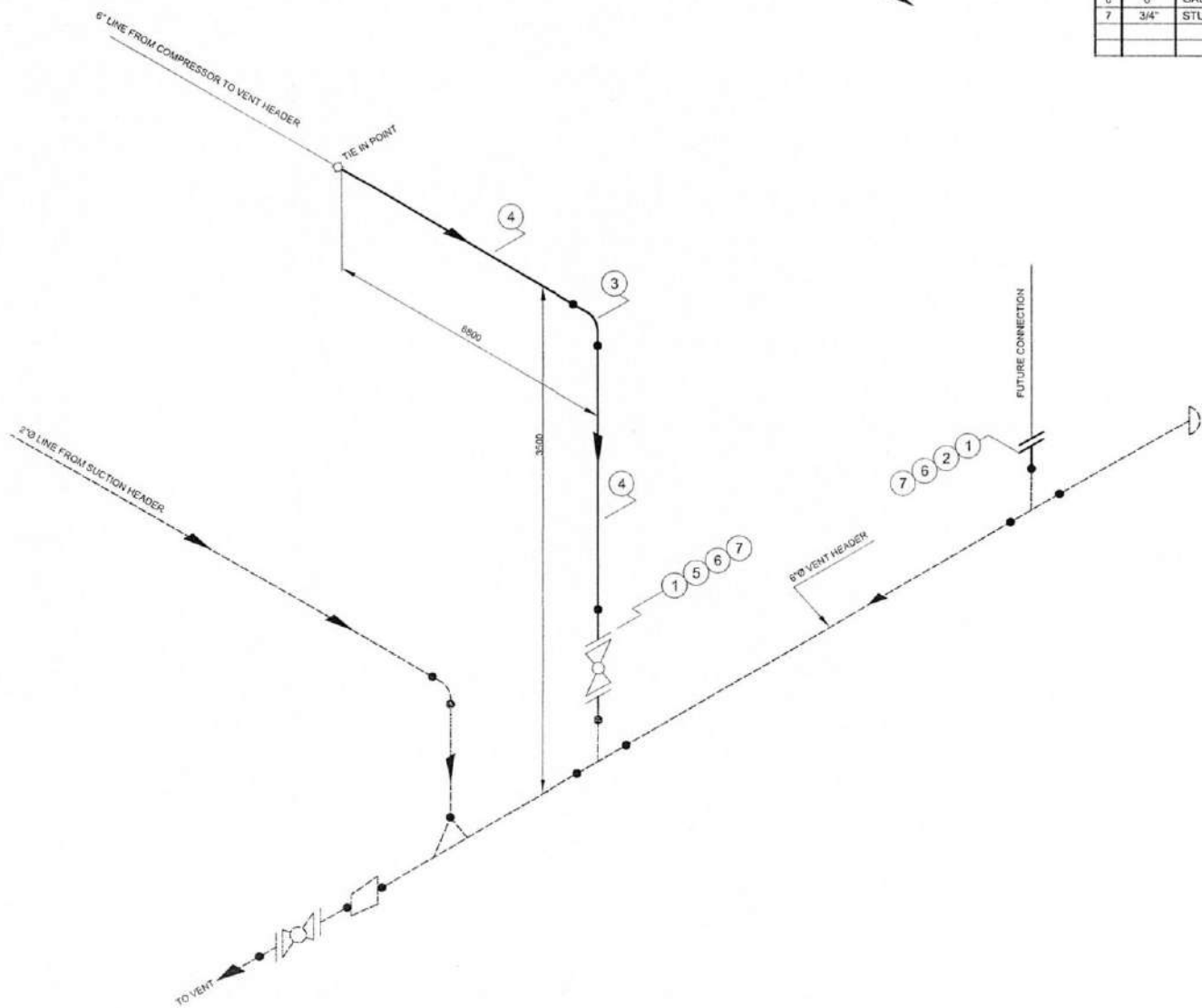

NEW LINE \_\_\_\_\_  
 EXIT LINE - - - - -

**NOTE:-**  
 1. PROVISIONAL DRAWING ONLY FOR BOQ.

Rev. 0	Issue For Approval			
Rev. No	Revision Note	Cad By	Checked By	Approved By
<b>OIL &amp; GAS DEVELOPMENT COMPANY LTD.</b> <b>PROCESS &amp; PLANTS DEPARTMENT</b> <b>Loti Gas Field</b>				
<b>TITLE:-</b> <b>6"Ø VENT LINE FROM COMPRESSOR TO VENT HEADER</b>				
CAD BY <b>JAWAD CHAUD</b> Sr.Tech.Officer(Draughting)	CHECKED BY Mian Muhd. Shaqique C.T.O (Mech.)	APPROVED BY Sohail Anwer Manager (P&P)C-B	DRAWING NO. PP-LOTI-ISO-017	
Scale: NTS	Computer Code PN_01	Rev. 0	Date 09-10-2018	